



Зип Общепит

vsezip.ru

+7(812)987-08-81



**GAS COMPONENTS**



**ELECTRIC COMPONENTS**



**WATER TECHNOLOGY**



**MECHANICAL COMPONENTS**



**TOOLS**

Spare parts suitable for

**HOONVED**

Find the complete and up-to-date range of products in our GEV Webshop

Зип Общепит

vsezip.ru

+7(812)987-08-81

# Manufacturer catalogue

The most important spare parts and accessories arranged clearly for every manufacturer



**Complete product range and all appliance data always up to date in the GEV Webshop**







**Alphabetical Index at the end of the catalogue**

## GEV Webshop

[www.gev-online.co.uk](http://www.gev-online.co.uk)

[www.gev-online.com](http://www.gev-online.com)



-  Add to Favourites
-  Sign In with email address and usual password
-  Easy-order – place several items in your basket at the same time
-  Quick Item search – no login needed





## heating elements

### heating elements for pasta cookers

			
1			
<b>GEV No.</b>	415020	<b>Ref. No.</b>	110331 H110331
<b>description</b>	heating element 4500W 230V mounting $\varnothing$ 57.5mm heating circuits 3 L 355mm W 35mm H 47mm number of thermostat sleeves 1 thermostat sleeves $\varnothing$ 7mm length thermostat sleeves 295mm thermostat sleeve upper tube $\varnothing$ 8.5mm hole distance 70mm hole $\varnothing$ 10mm connection length 25mm connection male faston 6.3mm 3 hole flange immersion heater		
<b>For models:</b>	HT100, HT150, HTP195, HTP205, HTP220		



### coil heating elements

			
1			
<b>GEV No.</b>	418823	<b>Ref. No.</b>	110704 H110704
<b>description</b>	heating element 1000W 230V L 405mm W 50mm H 25mm tube $\varnothing$ 8.5mm thread M14x1.5 connection M5 heating circuits 1		
<b>For models:</b>	HG2LR, HGLR, HT100, HT150, HTP195, HTP205, HTP220		

			
1			
<b>GEV No.</b>	418824	<b>Ref. No.</b>	H110706
<b>description</b>	heating element 1500W 230V L 428mm W 50mm H 25mm tube $\varnothing$ 8.5mm thread M14x1.5 connection M6 connection length 41mm heating circuits 1 2 hole fixing		
<b>For models:</b>	EDT100, EDT140, EDT170, EDT200, EDT230, EDT85, TR-E100, TR-E150, TR-E170, TR-E200, TR-E230, TR-E90		

### immersion heating elements

#### 3 hole flange $\varnothing$ 38.5mm



			
1			
<b>GEV No.</b>	415276	<b>Ref. No.</b>	25353 25360
<b>description</b>	heating element 2400W 230V mounting $\varnothing$ 38.5mm heating circuits 2 L 297mm W 34mm H 34mm tube $\varnothing$ 6.3mm hole distance 57mm hole $\varnothing$ 10mm 3 hole flange connection male faston 6.3mm immersion heater		
<b>For models:</b>	C3, C4, CM43, CMD43, E40, E43, NK43, NKD43, T3-80		
<b>accessories for</b>	415276		
	<b>GEV No.</b>	532577	<b>Ref. No.</b>
		O-ring EPDM thickness 5.34mm ID $\varnothing$ 40.65mm Qty 1 pcs	

Зип Общепит

vsezip.ru

+7(812)987-08-81

			
1			
<b>GEV No.</b>	415149	<b>Ref. No.</b>	30008
<b>description</b>	heating element 2800W 230V mounting $\varnothing$ 38.5mm heating circuits 2 L 300mm W 21mm H 35mm number of thermostat sleeves 1 thermostat sleeves $\varnothing$ 6.5mm length thermostat sleeves 53mm thermostat sleeve not clinging tube $\varnothing$ 6.3mm hole distance 57mm hole $\varnothing$ 10mm 3 hole flange connection male faston 6.3mm immersion heater		
<b>For models:</b>	C35, C43, C43ALTA, C43D, C48, C48D, C48DDL, C48DL, CR43, CR43D, CR48, CR48D, DP35, DP35D, DP40, DP40D, DP45, DP45D, DP50, DP50D, GS-X1011, GS-X1011-WEH, GS-X1021, GS-X1021-WEH, SP35, SP35ALTA, SP35D, SP40, SP40D, SP40DDL, SP40DL, SPR36, SPR36D, SPR41, SPR41D, STS43, STS43D, STS48, STS48D, STS53, STS53D, STS60, STS60D		
<b>accessories for</b>	415149		
	<b>GEV No.</b>	532577	<b>Ref. No.</b>
		O-ring EPDM thickness 5.34mm ID $\varnothing$ 40.65mm Qty 1 pcs	

			
1			
<b>GEV No.</b>	415167	<b>Ref. No.</b>	25356
<b>description</b>	heating element 3000W 230V mounting $\varnothing$ 38.5mm heating circuits 2 L 300mm W 21mm H 35mm number of thermostat sleeves 1 thermostat sleeves $\varnothing$ 6.5mm length thermostat sleeves 53mm thermostat sleeve not clinging tube $\varnothing$ 6.3mm hole distance 57mm hole $\varnothing$ 10mm 3 hole flange connection male faston 6.3mm immersion heater		
<b>For models:</b>	C35, C43ALTA, C48DDL, C48DL, C6, C6D, CR43, CR43D, CR48, CR48D, DP35, DP35D, DP35D-2, DP40, DP40D, DP45, DP45D, DP50, DP50D, E50, GS-X1011, GS-X1011-WEH, GS-X1021, GS-X1021-WEH, SP35ALTA, SP40DDL, SP40DL, SP5, SP5D, SPB35, SPR36, SPR36D, SPR41, SPR41D, STS43, STS43D, STS43D-2, STS48, STS48D, STS48D-2, STS53, STS53D, STS60, STS60D		
<b>spare parts for</b>	415167		
	<b>GEV No.</b>	521120	<b>Ref. No.</b>
		O-ring EPDM thickness 5.34mm ID $\varnothing$ 37.47mm Qty 1 pcs	
<b>accessories for</b>	415167		
	<b>GEV No.</b>	532577	<b>Ref. No.</b>
		O-ring EPDM thickness 5.34mm ID $\varnothing$ 40.65mm Qty 1 pcs	



Зип-Общелит

vsezip.ru

+7(812)987-08-81

<b>GEV No.</b>	415199	<b>Ref. No.</b>	25357 25358
<b>description</b>	heating element 4000W 400V mounting $\varnothing$ 38.5mm heating circuits 2 L 297mm W 33mm H 18mm number of thermostat sleeves thermostat sleeves $\varnothing$ 6.5mm length thermostat sleeves 135mm thermostat sleeve centre not clinging tube $\varnothing$ 6.5mm hole distance 57mm hole $\varnothing$ 10mm 3 hole flange connection male faston 6.3mm immersion heater		
<b>For models:</b>	APS43, APS48, APS48B, APS53, APS60, APSE43, APSE48, APSE53, APSE60, BPN48, BPS43, BPS52, C53, C53D, C60, C60D, CM52, CM60, CMD52, CMD60, DP40, DP40D, DP45, DP45D, DP50, DP50D, FW35, FW40, FW40B, FW45, FW50, K80F, K80G, M60, NK52, NK60, NKD52, NKD60, RSP50, RSP50A, SP45, SP45D, SP50, SP50-400V, SP50-440V, SP50D, STS48, STS48D, STS53, STS53D...(Other models you can see in the webshop)		
<b>accessories for</b>	415199		
	<b>GEV No.</b>	532577	<b>Ref. No.</b> —
	O-ring EPDM thickness 5.34mm ID $\varnothing$ 40.65mm Qty 1 pcs		

<b>GEV No.</b>	420356	<b>Ref. No.</b>	29655
<b>description</b>	heating element 5000W 230/400V mounting $\varnothing$ 38.5mm heating circuits 2 L 305mm W 33mm H 27mm tube $\varnothing$ 6.5mm hole distance 57mm hole $\varnothing$ 10mm 3 hole flange connection male faston 6.3mm immersion heater		
<b>For models:</b>	APS43, APS48, APS48B, APS53, APS60, APSE43, APSE48, APSE53, APSE60, FW35, FW40, FW40B, FW45, FW50		

<b>GEV No.</b>	415277	<b>Ref. No.</b>	25361
<b>description</b>	heating element 6000W 230V mounting $\varnothing$ 38.5mm heating circuits 3 L 360mm W 34mm H 55mm L1 35mm L2 70mm L3 255mm H1 27mm H2 28mm hole distance 57mm hole $\varnothing$ 10mm tube $\varnothing$ 6.3mm connection male faston 6.3mm immersion heater 3 hole flange		
<b>For models:</b>	ED650E, ED650S, ED700, ED900		
<b>accessories for</b>	415277		
	<b>GEV No.</b>	532577	<b>Ref. No.</b> —
	O-ring EPDM thickness 5.34mm ID $\varnothing$ 40.65mm Qty 1 pcs		

<b>GEV No.</b>	416390	<b>Ref. No.</b>	35484
<b>description</b>	heating element 3200W 230V mounting $\varnothing$ 47.5mm heating circuits 2 L 302mm W 37mm H 20mm tube $\varnothing$ 6.3mm hole distance 63mm hole $\varnothing$ 8/10mm connection length 10mm connection male faston 6.3mm 3 hole flange immersion heater		
<b>For models:</b>	C35, C35E, C43-2, C43DE, C43E, C46DE, C46E, C48-2, C48D-2, C48E, CDN3, CDN4, DP35-2, DP40-2, DP40D-2, DP40D-rib2, DP40-rib2, GS-X1011-2, GS-X1011-WEH-2, GS-X1021-2, GS-X1021-2rib, GS-X1021-WEH-2, GS-X1021-WEH-2rib, RSP40, RSP40A, SP35-2, SP35DE, SP35E, SP40-2, SP40D-2, SP40DE, SP40E, SPB35, SPB35E, ST43DE, ST43E, ST48DE, ST48E, STS43-2, STS43D-2, STS48-2, STS48D-2, STS48D-rib2, STS48-rib2, TDN4-2rib		
<b>accessories for</b>	416390		
	<b>GEV No.</b>	510408	<b>Ref. No.</b> 200820 8662
	O-ring EPDM thickness 5.34mm ID $\varnothing$ 47mm Qty 1 pcs		
	<b>GEV No.</b>	510562	<b>Ref. No.</b> —
	O-ring silicone thickness 5.34mm ID $\varnothing$ 47mm Qty 1 pcs		

<b>GEV No.</b>	416274	<b>Ref. No.</b>	H110398
<b>description</b>	heating element 5000W 230V mounting $\varnothing$ 47.5mm heating circuits 3 L 248mm W 36mm H 34mm number of thermostat sleeves 1 thermostat sleeves $\varnothing$ 7mm length thermostat sleeves 200mm thermostat sleeve eccentric, non clinging tube $\varnothing$ 6.5mm hole distance 64mm hole $\varnothing$ 8mm connection M4 3 hole flange immersion heater		
<b>spare parts for</b>	416274		
	<b>GEV No.</b>	510408	<b>Ref. No.</b> 200820 8662
	O-ring EPDM thickness 5.34mm ID $\varnothing$ 47mm Qty 1 pcs		
<b>accessories for</b>	416274		
	<b>GEV No.</b>	510562	<b>Ref. No.</b> —
	O-ring silicone thickness 5.34mm ID $\varnothing$ 47mm Qty 1 pcs		



Зип Общепит

vsezip.ru

+7(812)987-08-81



1

<b>GEV No.</b>	416273	<b>Ref. No.</b>	110397 H110397
<b>description</b>	heating element 3200W 230V mounting $\varnothing$ 42mm heating circuits 1 L 237mm W 35mm H 38mm number of thermostat sleeves 1 thermostat sleeves $\varnothing$ 7mm length thermostat sleeves 200mm thermostat sleeve not clinging tube $\varnothing$ 6.3mm hole distance 66mm hole $\varnothing$ 8mm connection length 26mm connection male faston 6.3mm 3 hole flange immersion heater		
<b>For models:</b>	DP40D-2, STS48D-2		
<b>accessories for</b>	416273		
	<b>GEV No.</b>	510408	<b>Ref. No.</b> 200820 8662
	O-ring EPDM thickness 5.34mm ID $\varnothing$ 47mm Qty 1 pcs		
	<b>GEV No.</b>	510562	<b>Ref. No.</b> —
	O-ring silicone thickness 5.34mm ID $\varnothing$ 47mm Qty 1 pcs		



1

<b>GEV No.</b>	415023	<b>Ref. No.</b>	110367 H110367
<b>description</b>	heating element 12500W 230V mounting $\varnothing$ 57.5mm heating circuits 3 L 630mm W 36mm H 48mm number of thermostat sleeves 1 thermostat sleeves $\varnothing$ 7mm length thermostat sleeves 295mm thermostat sleeve eccentric, non clinging tube $\varnothing$ 8.5mm hole distance 76mm hole $\varnothing$ 8x10mm connection M5 3 hole flange immersion heater		
<b>For models:</b>	EDT100, EDT140, EDT170, EDT200, EDT230, EDT85, HT100, HT150, HTP195, HTP205, HTP220, TR100, TR90, TR-E100, TR-E90		
<b>spare parts for</b>	415023		
	<b>GEV No.</b>	510409	<b>Ref. No.</b> 200815 33402 H200815
	O-ring EPDM thickness 5.34mm ID $\varnothing$ 56.52mm Qty 1 pcs		

3 hole flange  $\varnothing$ 57.5mm



1

<b>GEV No.</b>	418624	<b>Ref. No.</b>	110388 27298 H110388
<b>description</b>	heating element 10000W 230/400V mounting $\varnothing$ 57.5mm heating circuits 3 L 480mm W 35mm H 43mm number of thermostat sleeves 1 thermostat sleeves $\varnothing$ 7mm length thermostat sleeves 285mm tube $\varnothing$ 8.5mm hole distance 72mm hole $\varnothing$ 8mm immersion heater		
<b>For models:</b>	CA120, CA90, CAP10, CAP12, CAP12DE, CAP12EBT, CAP15EBT, CAP7E, ED650E, ED650E-90, ED650S, ED650S-90, EDT100, EDT140, EDT170, EDT200, EDT230, EDT85, HT100, HT150, HTP195, HTP205, HTP220, RCA1200, RCA1200i, SO120, SO55-400V3-50Hz-MARINE, TR140, TR200, TR230, TR-E170, TR-E200, TR-E230, TR-E90		
<b>spare parts for</b>	418624		
	<b>GEV No.</b>	510409	<b>Ref. No.</b> 200815 33402 H200815
	O-ring EPDM thickness 5.34mm ID $\varnothing$ 56.52mm Qty 1 pcs		





1

<b>GEV No.</b>	415060	<b>Ref. No.</b>	H110363
<b>description</b>	heating element 3000W 230V mounting $\varnothing$ 57.5mm heating circuits 1 L 330mm W 45mm H 29mm number of thermostat sleeves 1 thermostat sleeves $\varnothing$ 7mm length thermostat sleeves 295mm thermostat sleeve not clinging tube $\varnothing$ 6.25mm hole distance 73mm hole $\varnothing$ 8mm connection male faston 6.3mm 3 hole flange immersion heater		
<b>For models:</b>	C6DE, C6E, SP5DE, SP5E		



1

<b>GEV No.</b>	419061	<b>Ref. No.</b>	110335 37008
<b>description</b>	heating element 4000W 230/400V mounting $\varnothing$ 57.5mm heating circuits 3 L 295mm W 30mm H 42mm number of thermostat sleeves 1 thermostat sleeves $\varnothing$ 7.5mm length thermostat sleeves 300mm thermostat sleeve eccentric, non clinging tube $\varnothing$ 6.3mm hole distance 72mm hole $\varnothing$ 8/10mm connection length 22mm connection M4 3 hole flange immersion heater		
<b>For models:</b>	C53DE, C53E, C60DE, C60E, CAP12EBT, DP45DE, DP45E, DP50DE, DP50E, EDI4, HD40ALTABT, HD40BT, LO56, SO100-400V3-50Hz-MARINE, SO100-440V3-60Hz-MARINE, SP45DE, SP45E, SP50DE, SP50E, ST53DE, ST53E, ST60DE, ST60E		
<b>accessories for</b>	419061		
	<b>GEV No.</b>	510409	<b>Ref. No.</b> 200815 33402 H200815
	O-ring EPDM thickness 5.34mm ID $\varnothing$ 56.52mm Qty 1 pcs		



1

<b>GEV No.</b>	417403	<b>Ref. No.</b>	H110385
<b>description</b>	heating element 12000/14000W 240-415V heating circuits 3 L 620mm W 37mm H 51mm number of thermostat sleeves 1 thermostat sleeves $\varnothing$ 8.8mm length thermostat sleeves 290mm tube $\varnothing$ 10mm hole distance 73mm hole $\varnothing$ 8mm		
<b>For models:</b>	EDT100, EDT140, EDT170, EDT200, EDT230, EDT85		



electric components





Зип Общепит

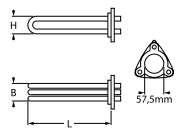

vsezip.ru

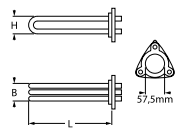
+7(812)987-08-81

			
			
<b>1</b>			
<b>GEV No.</b>	419062	<b>Ref. No.</b>	36250
<b>description</b>	heating element 4000W 230V mounting $\varnothing$ 57.5mm heating circuits 3 L 300mm W 37mm H 50mm number of thermostat sleeves 1 thermostat sleeves $\varnothing$ 7.5mm length thermostat sleeves 295mm thermostat sleeve eccentric, non clinging tube $\varnothing$ 8.5mm hole distance 72mm hole $\varnothing$ 8/10mm connection length 22mm connection M5 3 hole flange immersion heater		
<b>For models:</b>	C53DE, C53E, C60DE, C60E, CAP10, CAP10BT, CAP10DE, CAP12, CAP12DE, SO100, SO100-400V3-50Hz-MARINE, SO100-440V3-60Hz-MARINE, SO120, SP45DE, SP45E, SP50DE, SP50E		
<b>accessories for</b>	419062		
	<b>GEV No.</b>	510409	<b>Ref. No.</b> 200815 33402 H200815
O-ring EPDM thickness 5.34mm ID $\varnothing$ 56.52mm Qty 1 pcs			

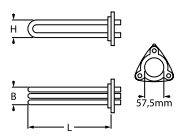
			
			
<b>1</b>			
<b>GEV No.</b>	415021	<b>Ref. No.</b>	110249 31007 33400 H110249
<b>description</b>	heating element 6000W 230V mounting $\varnothing$ 57.5mm heating circuits 3 L 343mm W 37mm H 50mm number of thermostat sleeves 1 thermostat sleeves $\varnothing$ 7mm length thermostat sleeves 294mm thermostat sleeve not clinging tube $\varnothing$ 8.5mm hole distance 72mm hole $\varnothing$ 8mm connection M5 3 hole flange		
<b>For models:</b>	AP53E, AP60E, APS60, C68DE, C68E, C81, C81E, C81EBT, C90, C90DE, C90E2, C90E, C90E2, C90EBT2, C98, CA120, CA55, CA90, CAP10, CAP10BT, CAP10DE, CAP7, CAP7E, ED550, ED600-95, ED630-90, ED650E, ED650E-90, ED650S, ED650S-90, ED700-90, ED900-90, EDI13, EDI13-2, EDI13ALTA, EDI13ALTA-2, EDI13ALTABT, EDI13BT, EDI4, EDI5, EDI6, EDI6-2, EDI6BT, EDI8, EDI8-2, EDI8BT, FW50, HD130BT, HD40ALTABT, HD40BT...(Other models you can see in the webshop)		
<b>accessories for</b>	415021		
	<b>GEV No.</b>	550002	<b>Ref. No.</b> —
tension strap H 10mm L 21mm W 10mm hole $\varnothing$ 6.5mm for heating element			

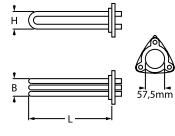
			
			
<b>1</b>			
<b>GEV No.</b>	415020	<b>Ref. No.</b>	110331 H110331
<b>description</b>	heating element 4500W 230V mounting $\varnothing$ 57.5mm heating circuits 3 L 355mm W 35mm H 47mm number of thermostat sleeves 1 thermostat sleeves $\varnothing$ 7mm length thermostat sleeves 295mm thermostat sleeve upper tube $\varnothing$ 8.5mm hole distance 70mm hole $\varnothing$ 10mm connection length 25mm connection male faston 6.3mm 3 hole flange immersion heater		
<b>For models:</b>	HT100, HT150, HTP195, HTP205, HTP220		

			
			
<b>1</b>			
<b>GEV No.</b>	415670	<b>Ref. No.</b>	110343 H110343
<b>description</b>	heating element 8000W 230V mounting $\varnothing$ 57.5mm heating circuits 3 L 480mm W 40mm H 50mm number of thermostat sleeves 1 thermostat sleeves $\varnothing$ 7mm length thermostat sleeves 295mm thermostat sleeve not clinging tube $\varnothing$ 10mm hole distance 72mm hole $\varnothing$ 8mm connection M5 3 hole flange immersion heater		
<b>For models:</b>	EDT100, EDT140, EDT170, EDT200, EDT230, EDT85, HG2LR, HGLR, HT100, HT150, HTP195, HTP205, HTP220, TR140, TR-E170, TR-E90		
<b>spare parts for</b>	415670		
	<b>GEV No.</b>	510409	<b>Ref. No.</b> 200815 33402 H200815
O-ring EPDM thickness 5.34mm ID $\varnothing$ 56.52mm Qty 1 pcs			

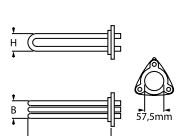
			
			
<b>1</b>			
<b>GEV No.</b>	420091	<b>Ref. No.</b>	110383 H110383
<b>description</b>	heating element 5000/6000W 240/415V mounting $\varnothing$ 57.5mm heating circuits 3 L 405mm W 36mm H 41mm number of thermostat sleeves 1 thermostat sleeves $\varnothing$ 7.5mm length thermostat sleeves 280mm tube $\varnothing$ 8.3mm hole distance 73mm hole $\varnothing$ 10mm connection M5 immersion heater		
<b>For models:</b>	60BT, 60BT-3, 60EBT, C68EBT, C6EBT, DP50EBT, EDT100, EDT140, EDT170, EDT200, EDT230, EDT85, SD5BT, ST48EBT, ST60EBT		

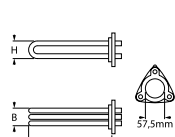

			
			
<b>1</b>			
<b>GEV No.</b>	417633	<b>Ref. No.</b>	110365 H110365
<b>description</b>	heating element 8000W 240/415V mounting $\varnothing$ 57.5mm heating circuits 3 L 400mm W 35mm H 46mm number of thermostat sleeves 1 thermostat sleeves $\varnothing$ 7.5mm length thermostat sleeves 290mm thermostat sleeve upper centre not clinging tube $\varnothing$ 10mm hole distance 73mm		
<b>For models:</b>	EDT100, EDT140, EDT170, EDT200, EDT230, EDT85		





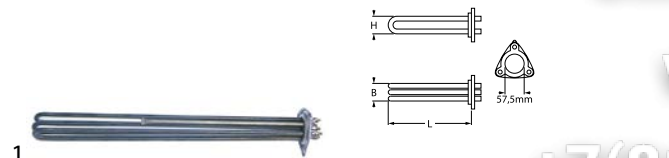

Зип Общепит

vsezip.ru

+7(812)987-09-81



			
<b>GEV No.</b>	415022	<b>Ref. No.</b>	100362 H110362
<b>description</b>	heating element 9000W 230/400V mounting $\phi$ 57.5mm heating circuits 3 L 475mm W 36mm H 43mm number of thermostat sleeves 1 thermostat sleeves $\phi$ 7mm length thermostat sleeves 300mm thermostat sleeve eccentric, non clinging tube $\phi$ 10mm hole distance 73mm hole $\phi$ 10mm connection length 30mm connection M5 3 hole flange immersion heater		
<b>For models:</b>	C90EBT, CAP10BT, EDI13, EDI13-2, EDI13ALTA, EDI13ALTA-2, EDI8, EDI8-2, EDT100, EDT140, EDT170, EDT200, EDT230, EDT85, LO134, LO134-2, LO134ALTA, LO134ALTA-2, LO83, LO83-2, RLO300, RLO400, TR100, TR140, TR170, TR200, TR230, TR90, TR-E100, TR-E150, TR-E170, TR-E200, TR-E230, TR-E90		
<b>spare parts for</b>	415022		
		<b>GEV No.</b>	510409 <b>Ref. No.</b> 200815 33402 H200815
O-ring EPDM thickness 5.34mm ID $\phi$ 56.52mm Qty 1 pcs			

			
<b>GEV No.</b>	415196	<b>Ref. No.</b>	25370
<b>description</b>	heating element 2000W 230V / heating circuits 2 thread 1" L 305mm W 34mm H 45mm H1 22mm H2 23mm tube $\phi$ 6.3mm connection male faston 6.3mm immersion heater flange with thread WS 30		
<b>For models:</b>	CM52, CM60, CMD52, CMD60, K80F, K80G, M60, NK60, NKD60, T5-80, T6-80		
<b>accessories for</b>	415196		
		<b>GEV No.</b>	510404 <b>Ref. No.</b> —
flat gasket fibre ED $\phi$ 44mm ID $\phi$ 34mm thickness 2mm Qty 1 pcs			
		<b>GEV No.</b>	510422 <b>Ref. No.</b> —
gasket copper ED $\phi$ 37.7mm ID $\phi$ 32.5mm thickness 2.7mm for thread 1"			
		<b>GEV No.</b>	520233 <b>Ref. No.</b> —
nut thread 1" H 6mm brass WS 47 Qty 1 pcs			

<b>3 hole flange <math>\phi</math>60.0mm</b>			
connection straight			
group 2			
			
<b>GEV No.</b>	420342	<b>Ref. No.</b>	110386 H110386
<b>description</b>	heating element 14000W 230/400V mounting $\phi$ 60mm heating circuits 3 L 620mm W 33mm H 49mm number of thermostat sleeves 1 thermostat sleeves $\phi$ 7.5mm length thermostat sleeves 290mm thermostat sleeve eccentric, non clinging tube $\phi$ 10mm hole distance 83mm hole $\phi$ 10mm connection M5 3 hole flange immersion heater		
<b>For models:</b>	EDT100, EDT140, EDT170, EDT200, EDT230, EDT85, TR100, TR90, TR-E100, TR-E90		

			
<b>GEV No.</b>	418902	<b>Ref. No.</b>	110269 35230
<b>description</b>	heating element 2000W 230V heating circuits 1 L 300mm W 140mm H 28mm thread M12x1 mounting distance 70mm tube $\phi$ 6.3mm connection male faston 6.3mm 2 hole fixing connection length 35mm immersion heater		
<b>For models:</b>	C35, C35E, C43-2, C43ALTA, C43DE, C43E, C46DE, C46E, C48-2, C48D-2, C48DDL, C48DL, C48E, C53, C53D, C60, C60D, CDN3, CDN4, DP35, DP35-2, DP35D, DP35D-2, DP40, DP40-2, DP40D, DP40D-2, DP40D-rib2, DP40-rib2, DP45, DP45D, DP50, DP50D, GS-X1011, GS-X1011-2, GS-X1011-WEH, GS-X1011-WEH-2, GS-X1021, GS-X1021-2, GS-X1021-2rib, GS-X1021-WEH, GS-X1021-WEH-2, GS-X1021-WEH-2rib, RSP40, RSP40A, SP35-2, SP35ALTA, SP35DE, SP35E, SP40-2...(Other models you can see in the webshop)		

<b>with expansion flange 70 x 18mm</b>			
			
<b>GEV No.</b>	415016	<b>Ref. No.</b>	33339
<b>description</b>	heating element 3000W 230V heating circuits 3 flange 70x18mm L 398mm W 60mm H 24mm connection male faston 6.3mm immersion heater expansion flange tube $\phi$ 6.3mm		
<b>For models:</b>	C81, C81E, C81EBT, C90, C90DE, C90E, C90EBT, C98, CA120, CA55, CA90, CAP7, CAP7E, ED550, ED650E, ED650S, LO50, LO50E, LO62, RCA1100, RCA1200, RCA1200i, RLO50, SMW15, SMW15E, SO55, SO55-400V3-50Hz-MARINE, SO55E, SP81, SP81E, US-X501		

			
<b>GEV No.</b>	415198	<b>Ref. No.</b>	30443 31380 35162
<b>description</b>	heating element 2000W 230V heating circuits 1 L 318mm W 85mm H 26mm thread M12x1 mounting distance 77mm tube $\phi$ 8.3mm connection male faston 6.3mm 2 hole fixing immersion heater		
<b>For models:</b>	60BT, 60BT-3, 60EBT, C3, C35, C4, C43, C43ALTA, C43D, C48, C48D, C48DDL, C48DL, C53, C53D, C53DE, C53E, C6, C60, C60D, C60DE, C60E, C68DE, C68E, C68EBT, C6D, C6DE, C6E, C6EBT, CDN3, CDN4, CR43, CR43D, CR48, CR48D, DP35, DP35D, DP40, DP40D, DP45, DP45D, DP45DE, DP45E, DP50, DP50D, DP50DE, DP50E, DP50EBT, E40-2F, GS-X1011...(Other models you can see in the webshop)		
<b>accessories for</b>	415198		
		<b>GEV No.</b>	520229 <b>Ref. No.</b> —
nut thread M12x1 H 4mm WS 16 zinc-coated steel Qty 1 pcs			
		<b>GEV No.</b>	521110 <b>Ref. No.</b> —
flat gasket fibre ED $\phi$ 20mm ID $\phi$ 13mm thickness 2mm Qty 1 pcs			

electric components



## foil heating elements

Зип-Общепит

bi-metal thermostats

vsezip.ru

+7(812)987-08-81



<b>GEV No.</b>	419007	<b>Ref. No.</b>	H110285
<b>description</b>	foil heating element L 380mm W 73mm 500W 230V t.max. 140°C with temperature limiter 140°C silicone cable length 200mm thickness 1mm connection male faston 6.3mm		
<b>For models:</b>	AP53E, AP60E		



<b>GEV No.</b>	390025	<b>Ref. No.</b>	120524 33948
<b>description</b>	bi-metal thermostat hole distance 40mm switch-off temp. 55/42°C NC/NO 2-pole 16A 250V connection F6.3 2 hole fixing		
<b>For models:</b>	60BT, 60BT-3, C35, C35E, C43, C43-2, C43ALTA, C43D, C43DE, C43E, C46DE, C46E, C48, C48-2, C48D, C48D-2, C48DDL, C48DL, C48E, C53, C53D, C6, C60, C60D, C6D, CDN3, CDN4, CR43, CR43D, CR48, CR48D, DP35, DP35-2, DP35D, DP35D-2, DP40, DP40-2, DP40D, DP40D-2, DP40D-rib2, DP40-rib2, DP45, DP45D, DP50, DP50D, DP50D-115V, GS-X1011, GS-X1011-2, GS-X1011-WEH, GS-X1011-WEH-2...(Other models you can see in the webshop)		
<b>accessories for</b>	390025		
	<b>GEV No.</b>	512154	<b>Ref. No.</b> H200494
	gasket for thermostat ID ø 20mm equiv. no. 200494/H200494 hole distance 41mm suitable for COMENDA, HOONVED		

## thermostats

## bi-metal thermostats

## safety bi-metal thermostats



<b>GEV No.</b>	390748	<b>Ref. No.</b>	36348
<b>description</b>	bi-metal safety thermostat hole distance 23.5mm switch-off temp. 100°C 1NC 1-poleA connection F6.3		
<b>For models:</b>	C35E, C81E, C81EBT, C90DE, C90E, C90EBT, C98, CAP7, CAP7E, LO50E, LO62, SO55, SO55-440V3-60Hz-MARINE, SO55E, SP81E, SPB35E		



<b>GEV No.</b>	390916	<b>Ref. No.</b>	35837
<b>description</b>	bi-metal safety thermostat hole distance 23.5mm switch-off temp. 68°C 1NC 16A connection F6.3 mounting ø 16mm		
<b>For models:</b>	C81E, C90E, C98, CAP7, LO50E, LO62, SO55, SO55-400V3-50Hz-MARINE, SO55-440V3-60Hz-MARINE, SP81E		

## control and safety thermostats

## IMIT / TEMPOMATIC / ARATHERMO

## control thermostats



<b>GEV No.</b>	390914	<b>Ref. No.</b>	120515
<b>description</b>	bi-metal thermostat t.max. 90°C temperature range 0-90°C 1-pole 1CO 10A probe ø 6.5mm probe L 97mm capillary pipe 1000mm capillary pipe isolated 950mm gland nut shaft ø 6x4.6mm shaft L 12mm shaft position upper rotation 270° with housing 250V		
<b>For models:</b>	HG2LR, HGLR		



<b>GEV No.</b>	390193	<b>Ref. No.</b>	25421
<b>description</b>	thermostat t.max. 56°C temperature range 0-90°C 1-pole 1CO 16A probe ø 6.5mm probe L 95mm capillary pipe 1500mm capillary pipe isolated 1500mm gland nut shaft ø 6mm shaft L 12mm shaft position upper rotation 270° probe material copper		
<b>For models:</b>	C3, C4, CM48, CM52, CM60, CMD43, CMD52, DP35, DP35D, DP40, DP40D, DP45, DP45D, DP50, DP50D, E40-2F, K80F, K80G, NK52, NK60, STS43, STS43D, STS48, STS48D, STS53, STS53D, STS60, STS60D, T5-80, T6-80, TS48, UNI43C, UNI48C, UNI48CD, UNI53C, UNI53R, UNI53RD, UNI60C		





Зип Общепит

vsezip.ru

(812)987-08-81





<b>GEV No.</b>	390014	<b>Ref. No.</b>	120525 H120525
<b>description</b>	thermostat t.max. 85°C temperature range 40-78 / 47-85°C 2-pole 2CO 16A probe ø 6.5mm probe L 95mm capillary pipe 1500mm capillary pipe isolated 1450mm gland nut shaft ø 6x4.6mm shaft L 15mm shaft position right rotation 270°		
<b>For models:</b>	60BT, 60BT-3, 60EBT, C35E, C43DE, C43E, C46DE, C46E, C48E, C53DE, C53E, C60DE, C60E, C68DE, C68E, C68EBT, C6DE, C6E, C6EBT, CAP7, CAP7E, DP45DE, DP45E, DP50DE, DP50E, GS-X1011, GS-X1011-2, GS-X1011-WEH, GS-X1011-WEH-2, GS-X1021, GS-X1021-2, GS-X1021-2rib, GS-X1021-WEH, GS-X1021-WEH-2, GS-X1021-WEH-2rib, SD5BT, SO55, SO55-400V3-50Hz-MARINE, SO55-440V3-60Hz-MARINE, SO55E, SP35DE, SP35E, SP40DE, SP40E, SP45DE, SP45E, SP50DE, SP50E, SP50E-400V3-50Hz-MARINE, SP50E-440V3-60Hz-MARINE...(Other models you can see in the webshop)		



<b>GEV No.</b>	390022	<b>Ref. No.</b>	120522 H120522
<b>description</b>	thermostat t.max. 90°C temperature range 30-90°C 1-pole 1CO 16A probe ø 9.5mm probe L 50mm capillary pipe 1000mm capillary pipe isolated 1000mm gland nut shaft L 19mm rotation 270°		
<b>For models:</b>	60EBT, C53DE, C53E, C60DE, C60E, C68DE, C68E, C68EBT, C6DE, C6E, C6EBT, DP45DE, DP45E, DP50DE, DP50E, DP50EBT, SP45DE, SP45E, SP50DE, SP50E, SP50E-400V3-50Hz-MARINE, SP50E-440V3-60Hz-MARINE, SP5DE, SP5E, SP68DE, SP68E, ST53DE, ST53E, ST60DE, ST60E, ST60EBT		



<b>GEV No.</b>	390006	<b>Ref. No.</b>	H120501
<b>description</b>	thermostat t.max. 86°C temperature range 0-86°C 1-pole 1CO 16A probe ø 6.5mm probe L 95mm capillary pipe 1500mm capillary pipe isolatedmm gland nut shaft ø 6x4.6mm shaft L 19mm rotation 270°		
<b>For models:</b>	EDT100, EDT140, EDT170, EDT200, EDT230, EDT85, TR100, TR140, TR170, TR200, TR230, TR90, TR-E100, TR-E150, TR-E170, TR-E200, TR-E230, TR-E90		
<b>accessories for</b>	390006		
	<b>GEV No.</b>	110100	<b>Ref. No.</b> —
	knob thermostat t.max. 90°C 0-90°C ø 42mm shaft ø 6x4.6mm shaft flat -135° black		
	<b>GEV No.</b>	110105	<b>Ref. No.</b> 191040 H191040
	rosette knob ø 42mm ø 56mm zero mark		



<b>GEV No.</b>	390736	<b>Ref. No.</b>	120525/1 38071
<b>description</b>	thermostat temperature range 37-76 / 46-85°C 2-pole 2CO 16A probe ø 6.5mm probe L 84mm capillary pipe 920mm capillary pipe isolated 845mm shaft ø 6x5mm shaft L 15mm rotation 90°		
<b>For models:</b>	60EBT, C35E, C43DE, C43E, C46DE, C46E, C53DE, C53E, C60DE, C60E, C68DE, C68E, C68EBT, C6DE, C6E, C6EBT, CAP7E, DP45DE, DP45E, DP50DE, DP50E, DP50EBT, HD130BT, HD40ALTABT, HD40BT, HD60BT, HD80BT, SO55E, SP35DE, SP35E, SP40DE, SP40E, SP45DE, SP45E, SP50DE, SP50E, SPB35E, ST43DE, ST43E, ST48DE, ST48E, ST48EBT, ST53DE, ST53E, ST60DE, ST60E, ST60EBT		



<b>GEV No.</b>	390192	<b>Ref. No.</b>	25417
<b>description</b>	thermostat t.max. 90°C temperature range 0-90°C 1-pole 1CO 16A probe ø 6.5mm probe L 95mm capillary pipe 2000mm capillary pipe isolated 2000mm gland nut shaft ø 6x4.6mm shaft L 19mm shaft position upper rotation 270° probe material copper		
<b>For models:</b>	APS43, APS48, APS53, APS60, APSE43, APSE48, APSE53, APSE60, C3, C35, C4, C43, C43ALTA, C43D, C48, C48D, C48DDL, C48DL, C53, C53D, C60, C60D, C98, CA55, CAP7, CAP7E, CDN3, CDN4, CM43, CM48, CM52, CMD43, CMD48, CMD52, CMD60, CR43, CR43D, CR48, CR48D, DP35, DP35D, DP40, DP40D, DP45, DP45D, DP50, DP50D, DP50D-115V, E36, E40...(Other models you can see in the webshop)		

safety thermostats



<b>GEV No.</b>	390773	<b>Ref. No.</b>	120519 H120519
<b>description</b>	safety thermostat switch-off temp. 135°C temperature range 95-135°C 1-pole 1CO 16A probe ø 5mm probe L 130mm capillary pipe 1000mm capillary pipe isolated 900mm gland nut probe		
<b>For models:</b>	AC101, AC151, AC181, AC201, AC241, AC91, CAP15EBT, EDT100, EDT140, EDT170, EDT200, EDT230, EDT85, HD130BT, HD40ALTABT, HD40BT, HD60BT, HD80BT, HT100, HT150, TR100, TR140, TR170, TR200, TR230, TR90, TR-E100, TR-E150, TR-E170, TR-E200, TR-E230, TR-E90		



# Зип-Общепит

various

vsezip.ru

+7(812)987-08-81

## RANCO

### safety thermostats

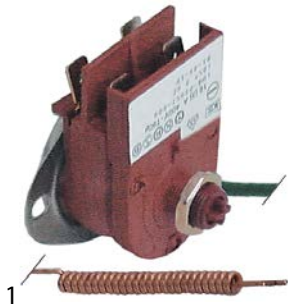

<b>GEV No.</b>	390473	<b>Ref. No.</b>	120536 33906
<b>description</b>	safety thermostat t.max. 105°C temperature range°C 2-pole 2NC 16A probe ø 6mm probe L 50mm capillary pipe 430mm capillary pipe isolated 310mm gland nut shaft ømm shaft Lmm shaft position rotation° probe material copper screw connection M10x0.75		
<b>For models:</b>	C35, C35E, C43, C43ALTA, C43D, C43DE, C43E, C46DE, C46E, C48, C48D, C48DDL, C48DL, C48E, C53, C53D, C60, C60D, C6DE, C6E, CDN3, CDN4, CR43, CR43D, CR48, CR48D, DP35, DP35D, DP40, DP40D, DP45, DP45D, DP50, DP50D, GS-X1011, GS-X1011-2, GS-X1011-WEH, GS-X1011-WEH-2, GS-X1021, GS-X1021-2, GS-X1021-2rib, GS-X1021-WEH, GS-X1021-WEH-2, GS-X1021-WEH-2rib, SP35, SP35ALTA, SP35D, SP35DE, SP35E, SP40...(Other models you can see in the webshop)		

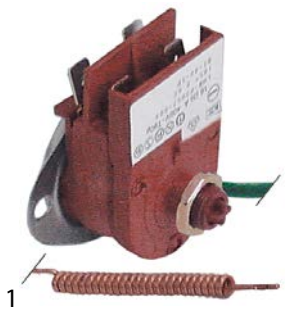

<b>GEV No.</b>	390469	<b>Ref. No.</b>	120526
<b>description</b>	safety thermostat t.max. 110°C temperature range°C 2-pole 2NC 16A probe ø 6mm probe L 50mm capillary pipe 1540mm capillary pipe isolated 160mm gland nut shaft ømm shaft Lmm shaft position rotation° probe material copper screw connection M10x0.75 switch-off temp. 110°C		

### thermostats



<b>GEV No.</b>	390474	<b>Ref. No.</b>	34534
<b>description</b>	thermostat t.max. 116°C capillary pipe isolatedmm gland nut 0-90°C		
<b>For models:</b>	C35, C43, C43-2, C43ALTA, C43D, C48, C48-2, C48D, C48D-2, C48DDL, C48DL, C53, C53D, C6, C60, C60D, C6D, CDN3, CDN4, CR43, CR43D, CR48, CR48D, DP35-2, DP35D-2, DP40-2, DP40D-2, DP40D-rib2, DP40-rib2, RSP40, RSP40A, SP35, SP35-2, SP35ALTA, SP35D, SP40, SP40-2, SP40D, SP40D-2, SP40DDL, SP40DL, SP45, SP45D, SP5, SP50, SP50-400V, SP50-440V, SP50D, SP5D, SPB35...(Other models you can see in the webshop)		

### safety thermostats



<b>GEV No.</b>	390194	<b>Ref. No.</b>	33745
<b>description</b>	safety thermostat switch-off temp. 90-110°C 1-pole 16A probe ø 6.5mm probe L 87mm capillary pipe 1500mm capillary pipe isolated 1497mm connection male faston 6.3mm adjustable		
<b>For models:</b>	60BT, 60BT-3, 60EBT, AP43E, AP48E, AP53E, AP60E, APS43, APS48, APS48B, APS53, APS60, APSE43, APSE48, APSE53, APSE60, C43, C43ALTA, C43D, C48, C48D, C48DDL, C48DL, C53, C53D, C53DE, C53E, C60, C60D, C60DE, C60E, C68DE, C68E, C68EBT, C6EBT, C81, C81E, C81EBT, C90, C90DE, C90DE2, C90E, C90E2, C90EBT, C90EBT2, C98, CA120, CA55, CA90, CAP10...(Other models you can see in the webshop)		

### accessories

#### plunger sockets



<b>GEV No.</b>	510935	<b>Ref. No.</b>	450515 H450515	
<b>description</b>	thermowell thread 1/2" L 107mm SS single ø 8mm			
<b>accessories for</b>	510935			
	<b>GEV No.</b>	361184	<b>Ref. No.</b>	—
	nut thread 1/2" H 6mm nickel-plated brass WS 24 Qty 1 pcs			
	<b>GEV No.</b>	521122	<b>Ref. No.</b>	—
	flat gasket fibre ED ø 31mm ID ø 21.5mm thickness 2mm for thread 1/2" Qty 1 pcs			



<b>GEV No.</b>	510986	<b>Ref. No.</b>	H450516	
<b>description</b>	thermowell thread 1/2" L 120mm SS double ø 6.5mm			
<b>For models:</b>	C90, C90DE, C90E, C90EBT, C98, CA120, CA55, CA90, CAP10, CAP10BT, CAP12, CAP7, CAP7E, ED550, ED650E, ED650S, EDI13, EDI13-2, EDI13ALTA, EDI13ALTA-2, EDI13ALTABT, EDI13BT, EDI6, EDI6-2, EDI6BT, EDI8, EDI8-2, EDI8BT, EDT100, EDT140, EDT170, EDT200, EDT230, EDT85, LO134, LO134-2, LO134ALTA, LO134ALTA-2, LO50, LO50E, LO62, LO67, LO67-2, LO83, LO83-2, RCA1100, RCA1200, RCA1200i, RLO200, RLO300...(Other models you can see in the webshop)			
<b>accessories for</b>	510986			
	<b>GEV No.</b>	361184	<b>Ref. No.</b>	—
	nut thread 1/2" H 6mm nickel-plated brass WS 24 Qty 1 pcs			
	<b>GEV No.</b>	521122	<b>Ref. No.</b>	—
	flat gasket fibre ED ø 31mm ID ø 21.5mm thickness 2mm for thread 1/2" Qty 1 pcs			



Зип Общепит  
vsezip.ru  
+7(812)987-08-81

miscellaneous			
			
1			
<b>GEV No.</b>	501353	<b>Ref. No.</b>	200491 H200491
<b>description</b>	gasket for thermostat hole ø 6.6mm L 98mm W 68mm thickness 2mm		
<b>For models:</b>	AC101, AC151, AC181, AC201, AC241, AC91, EDT100, EDT140, EDT170, EDT200, EDT230, EDT85, TR100, TR140, TR170, TR200, TR230, TR90, TR-E100, TR-E150, TR-E170, TR-E200, TR-E230, TR-E90		

			
1			
<b>GEV No.</b>	345846	<b>Ref. No.</b>	130459 H130459
<b>description</b>	momentary push switch mounting measurements 28.5x28.5mm grey 2CO 250V 16A START connection male faston 6.3mm ambient temperature max. 150°C protection IP40		

switches and momentary switches

rocker/momentary rocker switches

27.8x25mm			
			
1			
<b>GEV No.</b>	345000 <sup>1</sup>	<b>Ref. No.</b>	130421 H130421
<b>description</b>	momentary rocker switch mounting measurements 27.8x25mm orange 2CO 250V 16A illuminated START connection male faston 6.3mm ambient temperature max. 85°C protection IP40 2-pole male faston 6.3mm		

<sup>1</sup>illuminated

			
1			
<b>GEV No.</b>	347455	<b>Ref. No.</b>	36937
<b>description</b>	push switch mounting measurements 28.5x28.5mm green/red 2CO 250V 16A main switch connection male faston 6.3mm ambient temperature max. 150°C protection IP40 with indicator		
<b>For models:</b>	C43DE, C43E, C46DE, C46E, C53DE, C53E, C60DE, C60E, C68DE, C68E, C6DE, C6E, SP35DE, SP35E, SP40DE, SP40E, SP45DE, SP45E, SP50DE, SP50E, SP50E-400V3-50Hz-MARINE, SP50E-440V3-60Hz-MARINE, SP5DE, SP5E, SP68DE, SP68E		

			
1			
<b>GEV No.</b>	510281	<b>Ref. No.</b>	H160733
<b>description</b>	blank black mounting measurements 27.8x25mm		

			
1			
<b>GEV No.</b>	347492	<b>Ref. No.</b>	36489
<b>description</b>	push switch mounting measurements 28.5x28.5mm green/red 2CO 250V 16A main switch connection male faston 6.3mm ambient temperature max. 150°C protection IP40 with indicator		
<b>For models:</b>	60EBT, C43DE, C43E, C46DE, C46E, C53DE, C53E, C60DE, C60E, C68DE, C68E, C68EBT, C6DE, C6E, C6EBT, SP35DE, SP35E, SP40DE, SP40E, SP45DE, SP45E, SP50DE, SP50E, SP5DE, SP5E, SP68DE, SP68E		

push/momentary push switches

28.5x28.5mm			
			
1			
<b>GEV No.</b>	345928	<b>Ref. No.</b>	31185
<b>description</b>	momentary push switch mounting measurements 28.5x28.5mm grey 2NO 250V 16A connection male faston 6.3mm ambient temperature max. 150°C protection IP40		
<b>For models:</b>	BPN48, BPS43, BPS52, INDY43F, INDY48F, INDY53F, INDY60F		

			
1			
<b>GEV No.</b>	345845	<b>Ref. No.</b>	130460 H130460
<b>description</b>	push switch mounting measurements 28.5x28.5mm green/red 2CO 250V 16A ON-OFF connection male faston 6.3mm ambient temperature max. 150°C protection IP40		

			
1			
<b>GEV No.</b>	345227	<b>Ref. No.</b>	29009
<b>description</b>	push switch mounting measurements 28.5x28.5mm red/green 1CO 250V 16A connection male faston 6.3mm ambient temperature max. 150°C protection IP40 with indicator		
<b>For models:</b>	BPN48, BPS43, BPS52, CM48, CM52, CMD43, CMD52, INDY43F, INDY48F, INDY53F, INDY60F, TS43, TS48, UNI43C, UNI43R, UNI43RD, UNI48C, UNI48CD, UNI48R, UNI48RD, UNI53C, UNI53R, UNI53RD, UNI60C		

			
1			
<b>GEV No.</b>	345939	<b>Ref. No.</b>	34624 35336
<b>description</b>	momentary push switch mounting measurements 28.5x28.5mm black 1NO 250V 16A outflow connection male faston 6.3mm ambient temperature max. 150°C protection IP40		
<b>For models:</b>	60BT, 60BT-3, RSP50, RSP50A, SD5BT, VS-X313, VS-X313-LP-DOS, VS-X515, VS-X515-LP-DOS		



Зип Общепит

accessories

push buttons  
vsezip.ru

+7(812)987-08-81



1

<b>GEV No.</b>	347933	<b>Ref. No.</b>	34623
<b>description</b>	momentary push switch mounting measurements 28.5x28.5mm black 1NO 250V 16A START connection male faston 6.3mm ambient temperature max. 150°C		
<b>For models:</b>	60BT, 60BT-3, C98, EDI5, GS-X1011, GS-X1011-2, GS-X1011-WEH, GS-X1011-WEH-2, GS-X1021, GS-X1021-2, GS-X1021-2rib, GS-X1021-WEH, GS-X1021-WEH-2, GS-X1021-WEH-2rib, LO61, LO62, SD5BT, VS-X313, VS-X313-LP-DOS, VS-X515, VS-X515-LP-DOS		



1

<b>GEV No.</b>	345929	<b>Ref. No.</b>	34622
<b>description</b>	push switch mounting measurements 28.5x28.5mm black 2CO 250V 16A main switch connection male faston 6.3mm ambient temperature max. 150°C protection IP40		
<b>For models:</b>	60BT, 60BT-3, CA55, CAP7, ED550, GS-X1011, GS-X1011-2, GS-X1011-WEH, GS-X1011-WEH-2, GS-X1021, GS-X1021-2, GS-X1021-2rib, GS-X1021-WEH, GS-X1021-WEH-2, GS-X1021-WEH-2rib, SD5BT, SO55, SO55-400V3-50Hz-MARINE, SO55-440V3-60Hz-MARINE, VS-X313, VS-X313-LP-DOS, VS-X515, VS-X515-LP-DOS		



1

<b>GEV No.</b>	345925	<b>Ref. No.</b>	28785
<b>description</b>	push switch mounting measurements 28.5x28.5mm blue/green 1CO 250V 16A rinsing connection male faston 6.3mm ambient temperature max. 150°C protection IP40 with indicator		
<b>For models:</b>	CM43, CM48, CMD43, CMD48, CMD52, CMD60, E36, E40, E40-2F, E43, ED650E, ED650E-90, K80F, K80G, NK43, NK48, NKD43, NKD52, NKD60, T3-80, T4-80, T5-80		



1

<b>GEV No.</b>	345924	<b>Ref. No.</b>	28784
<b>description</b>	push switch mounting measurements 28.5x28.5mm green/red 1CO 250V 16A main switch connection male faston 6.3mm ambient temperature max. 150°C protection IP40 with indicator green/red		
<b>For models:</b>	CM43, CM48, K80F, K80G, NK43, NK48, T3-80, T4-80, T5-80		



1

<b>GEV No.</b>	345143	<b>Ref. No.</b>	28786
<b>description</b>	push switch mounting measurements 28.5x28.5mm green/red 2CO 250V 16A main switch connection male faston 6.3mm ambient temperature max. 150°C protection IP40 with indicator		
<b>For models:</b>	CMD43, CMD48, CMD60, E36, E40, E40-2F, E43, E50, ED650E, ED650E-90, M60, NKD48, NKD52, NKD60		

1

<b>GEV No.</b>	110089	<b>Ref. No.</b>	32514
<b>description</b>	push button black		
<b>For models:</b>	UNI43C, UNI43R, UNI43RD, UNI48C, UNI48CD, UNI48R, UNI48RD, UNI53C, UNI53R, UNI53RD, UNI60C		

## protective covers



1

<b>GEV No.</b>	524452	<b>Ref. No.</b>	25229
<b>description</b>	protection cap for switch L 145mm W 142mm H 120mm rubber		
<b>For models:</b>	ED600-95, ED700, ED700-90, ED900, ED900-90, LO122, LO60, LO78		

## microswitches

## lever actuated



1

<b>GEV No.</b>	345072	<b>Ref. No.</b>	H120329 H123328
<b>description</b>	microswitch with lever 250V 15A 2NO connection male faston 6.3mm L 42mm L1 44mm ambient temperature max. 85°C mounting distance 25mm type RM actuating force: 250g		

## pin-plunger actuated

M10



1

<b>GEV No.</b>	347603	<b>Ref. No.</b>	25552
<b>description</b>	microswitch with plunger thread M10x0.75 thread L 10mm 250V 16A 1CO connection male faston 6.3mm stroke 5mm mounting distance 22mm L 29mm ambient temperature max. 125°C type VRSR01DZ2 actuating force: 170g		
<b>For models:</b>	BPN48, BPS43, BPS52, C3, C4, CM43, CM48, CM52, CM60, CMD43, CMD48, CMD52, CMD60, E36, E40, E40-2F, E43, ED650E, ED650E-90, ED650S-90, INDY43F, INDY48F, INDY53F, INDY60F, K80F, K80G, NK43, NK48, NK52, NK60, NKD43, NKD48, NKD52, NKD60, T3-80, T4-80, T5-80, TS43, TS48, UNI43C, UNI43R, UNI43RD, UNI48C, UNI48CD, UNI48R, UNI48RD, UNI53C, UNI53R, UNI53RD, UNI60C		





Зип Общежит  
system switches (ROLD)

vsezip.ru

+7(812)987-08-81

electric components

M12			
			
1			
<b>GEV No.</b>	345350	<b>Ref. No.</b>	25553
<b>description</b>	microswitch with plunger mounting distance 22mm thread M12x0.75 thread L 16mm 250V 16A 1CO connection male faston 6.3mm stroke 4mm ambient temperature max. 125°C type EF83161.3 actuating force: 66g		
<b>For models:</b>	BPN48, BPS43, BPS52, ED650S, ED700, ED900		
<b>accessories for</b>	345350		
		<b>GEV No.</b>	345351
		<b>Ref. No.</b>	—
	nut thread M12x0.75 H 1.6mm WS 14 chrome-plated brass Qty 1 pcs		

roller actuated			
roller 0°			
			
1			
<b>GEV No.</b>	345923	<b>Ref. No.</b>	28843
<b>description</b>	microswitch with roller plunger 250V 16A 1CO connection screw ambient temperature max. 125°C thread L 14mm thread M12 mounting distance 25mm		
<b>For models:</b>	M60, T6-80		

position switches			
PIZZATO			
FD series			
			
1			
<b>GEV No.</b>	345075	<b>Ref. No.</b>	33435 870129 H870129
<b>description</b>	position switch cast aluminum 1NO/1NC 400V 3A L 141mm W 40mm H 35mm protection IP67 actuating force: 300g screw connection PG13.5 mounting distance 30x60mm type FD503		
<b>For models:</b>	CA120, CA55, CA90, CAP7, CAP7E, ED550, ED650E, ED650S, RCA1100, RCA1200, RCA1200i, SO55, SO55-400V3-50Hz-MARINE, SO55-440V3-60Hz-MARINE, SO55E		

			
1			
<b>GEV No.</b>	345057	<b>Ref. No.</b>	120320 H120320
<b>description</b>	position switch cast aluminum 1NO/1NC 400V 3A L 98mm W 40mm H 35mm protection IP67 actuating force: 450g screw connection PG13.5 mounting distance 30x60mm		
<b>For models:</b>	AC101, AC151, AC181, AC201, AC241, AC91, EDT100, EDT140, EDT170, EDT200, EDT230, EDT85		

1			
<b>GEV No.</b>	359244	<b>Ref. No.</b>	32916
<b>description</b>	blank ø 12.2mm grey (RAL7001)		
<b>For models:</b>	C3, C35, C4, C43, C43-2, C43ALTA, C43D, C48, C48-2, C48D, C48D-2, C48DDL, C48DL, C48E, C53, C53D, C6, C60, C60D, C81, CA120, CA90, CR43, CR43D, CR48, CR48D, ED650E, ED650S, SP35, SP35-2, SP35ALTA, SP35D, SP40, SP40-2, SP40D, SP40D-2, SP40DDL, SP40DL, SP40E, SP45, SP45D, SP5, SP50, SP50-400V, SP50-440V, SP50D, SP81, SPB35, SPR36, SPR36D...(Other models you can see in the webshop)		

			
1			
<b>GEV No.</b>	359249	<b>Ref. No.</b>	32196
<b>description</b>	blank ø 12.2mm grey (RAL7015)		
<b>For models:</b>	APS60, APSE60, FW50		

			
1			
<b>GEV No.</b>	345537	<b>Ref. No.</b>	37947
<b>description</b>	element holder mounting measurements 20.6x16.4mm grey arched for push buttons 13x17mm		
<b>For models:</b>	C35E, SPB35E		

			
1			
<b>GEV No.</b>	345131	<b>Ref. No.</b>	190140 H190140
<b>description</b>	element holder mounting measurements 28.5x28.5mm grey single element holder		

			
1			
<b>GEV No.</b>	359241	<b>Ref. No.</b>	33247
<b>description</b>	element holder mounting ø 16mm flat grey		
<b>For models:</b>	APS43, APS48, APS48B, APS53, APS60, APSE43, APSE48, APSE53, APSE60, C3, C35, C4, C43, C43-2, C43ALTA, C43D, C48, C48-2, C48D, C48D-2, C48DDL, C48DL, C48E, C53, C53D, C6, C60, C60D, C6D, C81, C90, CA120, CA90, CDN3, CDN4, CR43, CR43D, CR48, CR48D, DP35, DP35-2, DP35D, DP35D-2, DP40, DP40-2, DP40D, DP40D-2, DP40D-rib2, DP40-rib2, DP45...(Other models you can see in the webshop)		



Зип Общепит

vsezip.ru

+7(812)987-08-81



1

<b>GEV No.</b>	345601	<b>Ref. No.</b>	32891
<b>description</b>	indicator lamp holder V ø 11mm		
<b>For models:</b>	APS43, APS48, APS48B, APS53, APS60, APSE43, APSE48, APSE53, APSE60, C3, C35, C4, C43, C43-2, C43ALTA, C43D, C48, C48-2, C48D, C48D-2, C48DDL, C48DL, C48E, C53, C53D, C6, C60, C60D, C6D, C81, C90, CA120, CA90, CDN3, CDN4, CR43, CR43D, CR48, CR48D, DP35, DP35-2, DP35D, DP35D-2, DP40, DP40-2, DP40D, DP40D-2, DP40D-rib2, DP40-rib2, DP45...(Other models you can see in the webshop)		



1

<b>GEV No.</b>	359350	<b>Ref. No.</b>	34236
<b>description</b>	indicator light 230V blue connection male faston 6.3mm ø 11mm		
<b>For models:</b>	C35, C43, C43-2, C43ALTA, C43D, C48, C48-2, C48D, C48D-2, C48DDL, C48DL, C53, C53D, C6, C60, C60D, C6D, CDN3, CDN4, CR43, CR43D, CR48, CR48D, DP35, DP35-2, DP35D, DP35D-2, DP40, DP40-2, DP40D, DP40D-2, DP40D-rib2, DP40-rib2, DP45, DP45D, DP50, DP50D, SP35, SP35-2, SP35ALTA, SP35D, SP40, SP40-2, SP40D, SP40D-2, SP40DDL, SP40DL, SP45, SP45D, SP5...(Other models you can see in the webshop)		
<b>accessories for</b>	359350		
	<b>GEV No.</b>	345601	<b>Ref. No.</b> 32891
indicator lamp holder V ø 11mm			



1

<b>GEV No.</b>	346808	<b>Ref. No.</b>	34198
<b>description</b>	indicator light lens ø 12.2mm blue		
<b>For models:</b>	C35, C43, C43-2, C43ALTA, C43D, C48, C48-2, C48D, C48D-2, C48DDL, C48DL, C53, C53D, C6, C60, C60D, C6D, CDN3, CDN4, CR43, CR43D, CR48, CR48D, DP35, DP35-2, DP35D, DP35D-2, DP40, DP40-2, DP40D, DP40D-2, DP40D-rib2, DP40-rib2, DP45, DP45D, DP50, DP50D, SP35, SP35-2, SP35ALTA, SP35D, SP40, SP40-2, SP40D, SP40D-2, SP40DDL, SP40DL, SP45, SP45D, SP5...(Other models you can see in the webshop)		



1

<b>GEV No.</b>	359247	<b>Ref. No.</b>	32868
<b>description</b>	indicator light lens ø 12.2mm green		
<b>For models:</b>	APS43, APS48, APS48B, APS53, APS60, APSE43, APSE48, APSE53, APSE60, C3, C35, C4, C43, C43-2, C43ALTA, C43D, C48, C48-2, C48D, C48D-2, C48DDL, C48DL, C48E, C53, C53D, C6, C60, C60D, C6D, C81, C90, CA120, CA90, CR43, CR43D, CR48, CR48D, DP35, DP35-2, DP35D, DP35D-2, DP40, DP40-2, DP40D, DP40D-2, DP40D-rib2, DP40-rib2, DP45, DP45D, DP50, DP50D, ED650E, ED650S...(Other models you can see in the webshop)		



1

<b>GEV No.</b>	359245	<b>Ref. No.</b>	32867 32i4248
<b>description</b>	indicator light lens ø 12.2mm red		
<b>For models:</b>	APS43, APS48, APS48B, APS53, APS60, APSE43, APSE48, APSE53, APSE60, C3, C43ALTA, C43D, C48, C48D, C48DDL, C48DL, C53, C53D, C60, C60D, CR43, CR43D, CR48, CR48D, ED650E, ED650S, FW35, FW40, FW40B, FW45, FW50, SP35, SP35ALTA, SP35D, SP40, SP40D, SP40DDL, SP40DL, SP45, SP45D, SP50, SP50-400V, SP50-440V, SP50D, SPR36, SPR36D, SPR41, SPR41D		



1

<b>GEV No.</b>	359246	<b>Ref. No.</b>	32869
<b>description</b>	indicator light lens ø 12.2mm yellow		
<b>For models:</b>	APS43, APS48, APS48B, APS53, APS60, APSE43, APSE48, APSE53, APSE60, C3, C35, C4, C43, C43-2, C43ALTA, C43D, C48, C48-2, C48D, C48D-2, C48DDL, C48DL, C48E, C53, C53D, C6, C60, C60D, C6D, C81, C90, CA120, CA90, CDN3, CDN4, CR43, CR43D, CR48, CR48D, DP35, DP35-2, DP35D, DP35D-2, DP40, DP40-2, DP40D, DP40D-2, DP40D-rib2, DP40-rib2, DP45...(Other models you can see in the webshop)		



1

<b>GEV No.</b>	345130	<b>Ref. No.</b>	29529
<b>description</b>	momentary switch unit 1NO 250V 16A connection male faston 6.3mm		
<b>For models:</b>	APS43, APS48, APS48B, APS53, APS60, C3, C35, C4, C43, C43-2, C43ALTA, C43D, C48, C48-2, C48D, C48D-2, C48DDL, C48DL, C48E, C53, C53D, C6, C60, C60D, C6D, C81, CDN3, CDN4, CR43, CR43D, CR48, CR48D, DP35, DP35-2, DP35D, DP35D-2, DP40, DP40-2, DP40D, DP40D-2, DP40D-rib2, DP40-rib2, DP45, DP45D, DP50, DP50D, FW35, FW40, FW40B, FW45...(Other models you can see in the webshop)		



1

<b>GEV No.</b>	347193	<b>Ref. No.</b>	H130449
<b>description</b>	momentary switch unit 1NO 250V 16A connection male faston 6.3mm		



1

<b>GEV No.</b>	345606	<b>Ref. No.</b>	32870
<b>description</b>	momentary switch unit 2CO 250V 16A connection male faston 6.3mm		
<b>For models:</b>	APS43, APS48, APS53, APS60, APSE43, APSE48, APSE53, APSE60		





Зип Общепит

float switches

vsezip.ru

+7(812)987-08-81

			
1			
<b>GEV No.</b>	359243	<b>Ref. No.</b>	32390
<b>description</b>	push button ø 11.9mm grey		
<b>For models:</b>	APS43, APS48, APS48B, APS53, APS60, APSE43, APSE48, APSE53, APSE60, C35, C43, C43-2, C43ALTA, C43D, C48, C48-2, C48D, C48D-2, C48DDL, C48DL, C48E, C53, C53D, C6, C60, C60D, C6D, C81, CDN3, CDN4, CR43, CR43D, CR48, CR48D, DP35, DP35-2, DP35D, DP35D-2, DP40, DP40-2, DP40D, DP40D-2, DP40D-rib2, DP40-rib2, DP45, DP45D, DP50, DP50D, FW35, FW40...(Other models you can see in the webshop)		

			
1			
<b>GEV No.</b>	345539	<b>Ref. No.</b>	37946
<b>description</b>	push button size 17x13mm grey		
<b>For models:</b>	C35E, SPB35E		

			
1			
<b>GEV No.</b>	345719	<b>Ref. No.</b>	32872
<b>description</b>	switch 1CO 250V 16A connection male faston 6.3mm		
<b>For models:</b>	APS43, APS48, APS48B, APS53, APS60, APSE43, APSE48, APSE53, APSE60, C3, C35, C4, C43, C43-2, C43ALTA, C43D, C48, C48-2, C48D, C48D-2, C48DDL, C48DL, C53, C53D, C6, C60, C60D, C81, CR43, CR43D, CR48, CR48D, DP35, DP35-2, DP35D, DP40, DP40-2, DP40D, DP40-rib2, DP45, DP45D, DP50, DP50D, FW35, FW40, FW40B, FW45, FW50, RSP40, RSP50...(Other models you can see in the webshop)		

			
1			
<b>GEV No.</b>	345651	<b>Ref. No.</b>	33596
<b>description</b>	switch 2CO 250V 16A connection male faston 6.3mm		
<b>For models:</b>	C43-2, C43D, C48-2, C48D, C48D-2, C48DDL, C53D, C60D, C6D, CDN3, CDN4, CR43D, CR48D, DP35D, DP35D-2, DP40D, DP40D-2, DP40D-rib2, DP45D, DP50D, SP35-2, SP35D, SP40-2, SP40D, SP40D-2, SP40DDL, SP45D, SP50D, SP5D, SPR36D, SPR41D, STS43D, STS43D-2, STS48D, STS48D-2, STS48D-rib2, STS53D, STS60D, TDN4-2rib, TN-TDN5, TN-TDN6		

			
1			
<b>GEV No.</b>	347098	<b>Ref. No.</b>	32873
<b>description</b>	switch 2CO 250V 16A connection male faston 6.3mm		
<b>For models:</b>	C35E, C48E, RSP40A, RSP50A, SP40E, SPB35E		

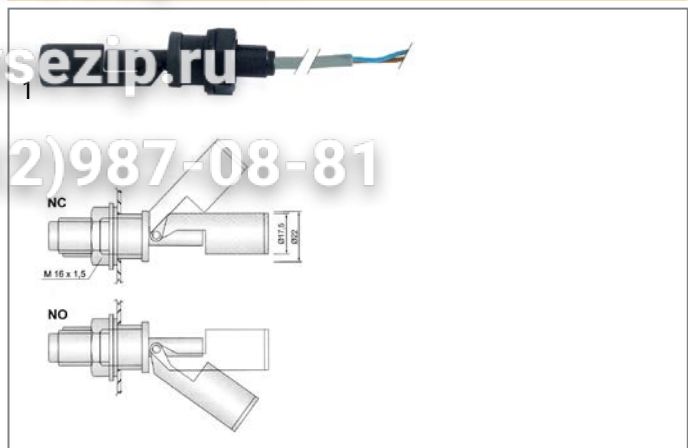

<b>GEV No.</b>	345822	<b>Ref. No.</b>	120358 H120358
<b>description</b>	float switch thread M16x1.5 1NO or 1NC ø 17.4mm L 98mm mounting ø 16mm 250V 0.5A cable cable length 2000mm		
<b>For models:</b>	60BT, SD5BT		

rotary switches

BREMAS

A1200 series

			
1			
<b>GEV No.</b>	345019	<b>Ref. No.</b>	H120712
<b>description</b>	rotary switch sets of contacts 2 2 0-1 type CA0120002 380V 12A shaft ø 5x5mm shaft L 23mm shaft square connection screw		
<b>For models:</b>	EDT85, TR100, TR90, TR-E90		

A1600 series

			
1			
<b>GEV No.</b>	300222	<b>Ref. No.</b>	H120715
<b>description</b>	rotary switch 3 0-1-2 sets of contacts 4 type CS0167133 400V 16A shaft ø 5x5mm shaft L 24mm shaft square connection screw		
<b>For models:</b>	EDT140, EDT170, EDT200, EDT230, TR140, TR170, TR200		

			
1			
<b>GEV No.</b>	345838	<b>Ref. No.</b>	120744 H120744
<b>description</b>	rotary switch 3 0-1-2 sets of contacts 4 type CS0168505 400V 16A shaft ø 5x5mm shaft L 23mm shaft square connection screw		
<b>For models:</b>	RCA1100		

electric components

Зип Общежит  
magnetic switches

36x13mm  
vsezip.ru

7(812)987-08-81



1

<b>GEV No.</b>	300330	<b>Ref. No.</b>	110805 H110805 old version
<b>description</b>	rotary switch 3 1-0-2 sets of contacts 2 type CS0168351 400V 16A shaft $\varnothing$ 5x5mm shaft L 25mm shaft square connection screw		

A1700 series



1

<b>GEV No.</b>	300262	<b>Ref. No.</b>	H110805
<b>description</b>	rotary switch 3 1-0-2 sets of contacts 2 400V 16A shaft $\varnothing$ 5x5mm shaft L 25mm shaft square connection screw		
<b>For models:</b>	EDT140, EDT170, EDT200, EDT230, TR140, TR170, TR200		



1

<b>GEV No.</b>	345007	<b>Ref. No.</b>	H120713
<b>description</b>	rotary switch 4 0-1-2-3 sets of contacts 6 type CS0178766 400V 20A shaft $\varnothing$ 5x5mm shaft L 25mm shaft square connection screw		
<b>For models:</b>	C98, EDI5, LO61, LO62, RCA1200, RCA1200i		

A2500 series



1

<b>GEV No.</b>	347687	<b>Ref. No.</b>	H120733
<b>description</b>	rotary switch 3 0-1-2 sets of contacts 4 type CS0257997 600V 32A shaft $\varnothing$ 5x5mm shaft L 24mm shaft square connection screw		



1

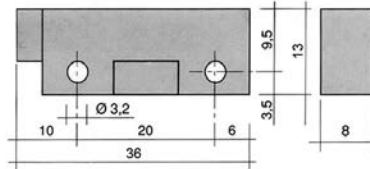

<b>GEV No.</b>	345335	<b>Ref. No.</b>	33188
<b>description</b>	magnetic switch L 36mm W 13mm 1NO 250V 0.04A P max. 10W connection cable cable length 960mm		
<b>For models:</b>	60BT, 60BT-3, 60EBT, AP43E, AP48E, AP53E, AP60E, APS43, APS48, APS48B, AP53, APS60, APSE43, APSE48, APSE53, APSE60, C35, C35E, C43, C43-2, C43ALTA, C43D, C43DE, C43E, C46DE, C46E, C48, C48-2, C48D, C48D-2, C48DDL, C48DL, C48E, C53, C53D, C53DE, C53E, C6, C60, C60D, C60DE, C60E, C68DE, C68E, C68EBT, C6D, C6DE, C6E, C81, C81E...(Other models you can see in the webshop)		
<b>accessories for</b>	345335		
		<b>GEV No.</b>	519049
		<b>Ref. No.</b>	32969
	magnet $\varnothing$ mm L 63mm H 10.7mm W 18.8mm hole distance 52mm M2 hole $\varnothing$ 2mm		

65x20mm



1

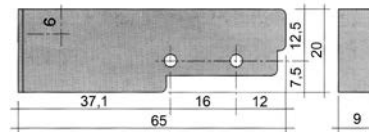

<b>GEV No.</b>	345122 <sup>1</sup>	<b>Ref. No.</b>	120342 32968 H120342
<b>description</b>	magnetic switch L 65mm W 20mm 1NO 24V 8A P max. 192W connection male faston 6.3mm cable length 344mm		
<b>For models:</b>	AC101, AC151, AC181, AC201, AC241, AC91, CAP10, CAP10BT, CAP10DE, CAP12, CAP12DE, CAP12EBT, CAP7E, ED600-95, ED700-90, ED900-90, EDI13, EDI13ALTA, EDI5, EDI6, EDI8, EDT100, EDT140, EDT170, EDT200, EDT230, EDT85, HT100, HT150, HTP195, HTP205, HTP220, LO122, LO134, LO134ALTA, LO60, LO61, LO67, LO78, LO83, RLO200, RLO300, RLO400, SO100, SO100-400V3-50Hz-MARINE, SO100-440V3-60Hz-MARINE, SO120, TR100, TR140, TR170...(Other models you can see in the webshop)		

<sup>1</sup>with coded connector





Зип Общежит  
control equipment

vsezip.ru  
push buttons

+7(812)987-08-81



1

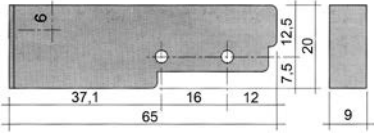

<b>GEV No.</b>	345116	<b>Ref. No.</b>	32968
<b>description</b>	magnetic switch L 65mm W 20mm 1NO 250V 0.4A P max. 100W connection cable cable length 3000mm		
<b>accessories for</b>	345116		
	<b>GEV No.</b>	345399	<b>Ref. No.</b> —
	magnet ø 3.3mm L 40mm H 8mm W 13mm hole distance 30mm M3		

**miscellaneous**



1

<b>GEV No.</b>	347477	<b>Ref. No.</b>	H120317
<b>description</b>	magnetic switch cable length 520mm		
<b>For models:</b>	EDT100, EDT140, EDT170, EDT200, EDT230, EDT85, TR100, TR140, TR170, TR200, TR230, TR90, TR-E100, TR-E150, TR-E170, TR-E200, TR-E230, TR-E90		

**accessories**

**magnets**

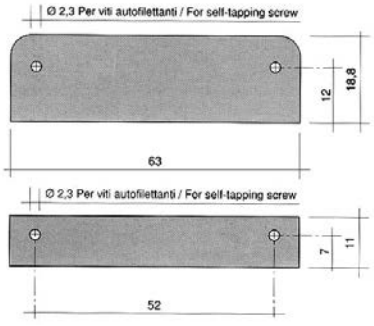
1

<b>GEV No.</b>	519049	<b>Ref. No.</b>	32969
<b>description</b>	magnet ømm L 63mm H 10.7mm W 18.8mm hole distance 52mm M2 hole ø 2mm		
<b>For models:</b>	60BT, 60BT-3, 60EBT, APS43, APS48, APS48B, APS53, APS60, APSE43, APSE48, APSE53, APSE60, C35, C35E, C43, C43-2, C43ALTA, C43D, C43DE, C43E, C46DE, C46E, C48, C48-2, C48D, C48D-2, C48DDL, C48DL, C48E, C53, C53D, C53DE, C53E, C6, C60, C60D, C60DE, C60E, C68DE, C68E, C68EBT, C6D, C6DE, C6E, C81, C81E, C81EBT, C90, C90DE, C90DE2...(Other models you can see in the webshop)		
<b>accessories for</b>	519049		
	<b>GEV No.</b>	560095	<b>Ref. No.</b> 25684
	sheet metal screws ø 2.9mm L 9.5mm SS Qty 20 pcs DIN 7981/ISO 7049 head ø 5.6mm oval head		

**SCHLEGEL**



1

<b>GEV No.</b>	345932	<b>Ref. No.</b>	25460
<b>description</b>	momentary switch unit mounting measurements ø16/24x24mm type momentary black/blue square		



1

<b>GEV No.</b>	345930	<b>Ref. No.</b>	25454
<b>description</b>	momentary switch unit mounting measurements ø16/24x24mm type momentary black/red square		
<b>For models:</b>	T6-80		

**switch blocks**



1

<b>GEV No.</b>	359194	<b>Ref. No.</b>	25456
<b>description</b>	contact block latching 1NC/1NO connection male faston 2.8mm illuminable socket T5.5K type AFL		
<b>For models:</b>	T6-80		



1

<b>GEV No.</b>	359186	<b>Ref. No.</b>	25457
<b>description</b>	contact block momentary 1NC/1NO connection male faston 2.8mm illuminable socket T5.5K type ATL		
<b>For models:</b>	T6-80		

**ABB**



1

<b>GEV No.</b>	348089	<b>Ref. No.</b>	H130410
<b>description</b>	contact block ABB MCB-01 1NC max 400V 8A black/red		
<b>For models:</b>	EDT100, EDT140, EDT170, EDT200, EDT230, EDT85		

electric components



Зип Общепит

vsezip.ru

+7(812)987-08-81



1

<b>GEV No.</b>	347987	<b>Ref. No.</b>	H130411
<b>description</b>	contact block ABB MCB-10 1NO max 400V 8A black/green		
<b>For models:</b>	EDT100, EDT140, EDT170, EDT200, EDT230, EDT85		
<b>accessories for</b>	347987		



<b>GEV No.</b>	347986	<b>Ref. No.</b>	H130413
<b>description</b>	push button mounting measurements ø22mm green		

ø22mm

push buttons



1

<b>GEV No.</b>	347986	<b>Ref. No.</b>	H130413
<b>description</b>	push button mounting measurements ø22mm green		
<b>For models:</b>	EDT100, EDT140, EDT170, EDT200, EDT230, EDT85		
<b>accessories for</b>	347986		



<b>GEV No.</b>	347987	<b>Ref. No.</b>	H130411
<b>description</b>	contact block ABB MCB-10 1NO max 400V 8A black/green		

switches (complete)



1

<b>GEV No.</b>	347573	<b>Ref. No.</b>	130453 H130453
<b>description</b>	emergency stop switch complete yellow/red		
<b>For models:</b>	AC101, AC151, AC181, AC201, AC241, AC91, EDT100, EDT140, EDT170, EDT200, EDT230, EDT85, TR100, TR140, TR170, TR200, TR230, TR90, TR-E100, TR-E150, TR-E170, TR-E200, TR-E230		

TELEMECANIQUE (EFA)

XA2 series



1

<b>GEV No.</b>	345220	<b>Ref. No.</b>	30079
<b>description</b>	contact block EFA ZB2BE101 1NO max 230V 10(6)A black		
<b>For models:</b>	DP50D-115V, ED650S-90		



1

<b>GEV No.</b>	345221	<b>Ref. No.</b>	29248
<b>description</b>	contact block EFA ZB2BE102 1NC max 230V 10(6)A black		
<b>For models:</b>	DP50D-115V, ED630-90, ED650S-90		

XB2 series



1

<b>GEV No.</b>	345935	<b>Ref. No.</b>	31963
<b>description</b>	contact block 1NO		
<b>For models:</b>	C90, CA120, CA90, DP50D-115V, ED600-95, ED650E, ED650S, ED700-90, ED900-90, LO122, LO50, LO60, LO78, RLO50, SMW15, US-X501		



1

<b>GEV No.</b>	345220	<b>Ref. No.</b>	30079
<b>description</b>	contact block EFA ZB2BE101 1NO max 230V 10(6)A black		
<b>For models:</b>	DP50D-115V, ED650S-90		



1

<b>GEV No.</b>	345221	<b>Ref. No.</b>	29248
<b>description</b>	contact block EFA ZB2BE102 1NC max 230V 10(6)A black		
<b>For models:</b>	DP50D-115V, ED630-90, ED650S-90		



1

<b>GEV No.</b>	345937	<b>Ref. No.</b>	34035
<b>description</b>	contact block with holder 1NO		
<b>For models:</b>	C90, CA120, CA90, ED650E, ED650S, EDI13, EDI13ALTA, EDI6, EDI8, LO134, LO134ALTA, LO50, LO67, LO83, RLO200, RLO300, RLO400, RLO50, SMW15, US-X501		





Зип-Общепит

vsezip.ru

+7(812)987-08-81

			
1			
<b>GEV No.</b>	345938	<b>Ref. No.</b>	34036
<b>description</b>	contact block with holder 1NO/1NC		
<b>For models:</b>	C90, CA120, CA90, DP50D-115V, ED650E, ED650S, LO50, RLO50, SMW15, US-X501		

			
1			
<b>GEV No.</b>	347934	<b>Ref. No.</b>	36871
<b>description</b>	push button mounting measurements ø22mm black		

<b>switches (complete)</b>			
			
1			
<b>GEV No.</b>	345933	<b>Ref. No.</b>	26931
<b>description</b>	rotary selector mounting measurements ø22mm		
<b>For models:</b>	ED630-90, ED650S, ED650S-90		

<b>miscellaneous</b>			
			
1			
<b>GEV No.</b>	345936	<b>Ref. No.</b>	31962
<b>description</b>	contact block 1NC		
<b>For models:</b>	C90, CA120, CA90, DP50D-115V, ED650E, ED650S, LO50, RLO50, SMW15, US-X501		

<b>rotary switches</b>			
			
1			
<b>GEV No.</b>	345222	<b>Ref. No.</b>	32069
<b>description</b>	rotary selector mounting measurements ø22mm black latching sequence 0-1		
<b>For models:</b>	C90, CA120, CA90, ED650E, ED650S, EDI13, EDI13ALTA, EDI6, EDI8, LO134, LO134ALTA, LO50, LO67, LO83, RLO200, RLO300, RLO400, RLO50, SMW15, US-X501		

			
1			
<b>GEV No.</b>	347932	<b>Ref. No.</b>	32070
<b>description</b>	indicator socket L 39mm 1-pole		
<b>For models:</b>	ED600-95, ED700-90, ED900-90, LO122, LO60, LO78		

			
1			
<b>GEV No.</b>	345223	<b>Ref. No.</b>	31053 31420
<b>description</b>	rotary selector mounting measurements ø22mm black latching sequence 1-0-2		
<b>For models:</b>	C90, CA120, CA90, DP50D-115V, ED630-90, ED650E, ED650S, ED650S-90, LO50, RLO50, SMW15, US-X501		

			
1			
<b>GEV No.</b>	347493	<b>Ref. No.</b>	32071
<b>description</b>	signal element blue L 28mm socket bayonet 2mm with gasket ø 30mm		
<b>For models:</b>	ED600-95, ED700-90, ED900-90, LO122, LO60, LO78		

			
1			
<b>GEV No.</b>	347410	<b>Ref. No.</b>	32065
<b>description</b>	rotary selector mounting measurements ø22mm green latching sequence 0-1		
<b>For models:</b>	ED600-95, ED700-90, ED900-90, LO122, LO60, LO78		

<b>encoders and potentiometers</b>			
			
1			
<b>GEV No.</b>	403273	<b>Ref. No.</b>	34908
<b>description</b>	encoder rotation 135° shaft ø 6mm shaft L 5mm cycle ø 26mm		
<b>For models:</b>	EDI13, EDI13ALTA, EDI6, EDI8, LO134, LO134ALTA, LO67, LO83, RLO200, RLO300, RLO400		

→ electric components



# lamps

## indicator lights

### indicator lights 2-piece (lens and indicator lamp)

#### indicator light lenses

ø10mm (type SRZ-2)



<b>GEV No.</b>	359359	<b>Ref. No.</b>	34605
<b>description</b>	indicator light housings mounting measurements ø10mm green square		
<b>For models:</b>	60BT, 60BT-3, C98, CA55, CAP7, ED550, EDI5, GS-X1011, GS-X1011-2, GS-X1011-WEH, GS-X1011-WEH-2, GS-X1021, GS-X1021-2, GS-X1021-2rib, GS-X1021-WEH, GS-X1021-WEH-2, GS-X1021-WEH-2rib, LO61, LO62, SD5BT, SO55, SO55-400V3-50Hz-MARINE, SO55-440V3-60Hz-MARINE, VS-X313, VS-X313-LP-DOS, VS-X515, VS-X515-LP-DOS		



<b>GEV No.</b>	359808	<b>Ref. No.</b>	34627
<b>description</b>	indicator light housings mounting measurements ø10mm green temperature		
<b>For models:</b>	C98, CA55, CAP7, ED550, EDI5, GS-X1011, GS-X1011-2, GS-X1011-WEH, GS-X1011-WEH-2, GS-X1021, GS-X1021-2, GS-X1021-2rib, GS-X1021-WEH, GS-X1021-WEH-2, GS-X1021-WEH-2rib, LO61, LO62, SO55, SO55-400V3-50Hz-MARINE, SO55-440V3-60Hz-MARINE, VS-X313, VS-X313-LP-DOS, VS-X515, VS-X515-LP-DOS		



<b>GEV No.</b>	359358	<b>Ref. No.</b>	34604
<b>description</b>	indicator light housings mounting measurements ø10mm orange square		
<b>For models:</b>	60BT, 60BT-3, C98, CA55, CAP7, ED550, EDI5, GS-X1011, GS-X1011-2, GS-X1011-WEH, GS-X1011-WEH-2, GS-X1021, GS-X1021-2, GS-X1021-2rib, GS-X1021-WEH, GS-X1021-WEH-2, GS-X1021-WEH-2rib, LO61, LO62, SD5BT, SO55, SO55-400V3-50Hz-MARINE, SO55-440V3-60Hz-MARINE, VS-X313, VS-X313-LP-DOS, VS-X515, VS-X515-LP-DOS		

### indicator lamps for socket type SRZ / SDK / SDY / SFK



<b>GEV No.</b>	359130	<b>Ref. No.</b>	28870
<b>description</b>	indicator lamp 230V clear connection male faston 6.3mm ø 8mm		
<b>For models:</b>	APS43, APS48, APS53, APS60, C3, C35, C4, C43, C43-2, C43ALTA, C43D, C48, C48-2, C48D, C48D-2, C48DDL, C48DL, C53, C53D, C6, C60, C60D, C6D, C98, CA55, CAP7, CDN3, CDN4, CM43, CM48, CM52, CM60, CMD43, CMD48, CMD52, CR43, CR43D, CR48, CR48D, DP35, DP35-2, DP35D, DP35D-2, DP40, DP40-2, DP40D, DP40D-2, DP40D-rib2, DP40-rib2, DP45...(Other models you can see in the webshop)		



<b>GEV No.</b>	359129	<b>Ref. No.</b>	33187
<b>description</b>	indicator lamp 24V clear connection male faston 6.3mm		
<b>For models:</b>	APS43, APS48, APS48B, APS53, APS60, APSE43, APSE48, APSE53, APSE60, C48E, C81, C90, CA120, CA90, CAP7, ED650E, ED650S, FW35, FW40, FW40B, FW45, FW50, LO50, RLO50, SMW15, SO55, SP40E, SP81, US-X501		

Зип Общепит

vsezip.ru

+7(812)987-08-81

<b>GEV No.</b>	359132	<b>Ref. No.</b>	32892
<b>description</b>	indicator lamp green 250V connection male faston 6.3mm protection 1.54 ar b a temperature max. 85°C		
<b>For models:</b>	60BT, 60BT-3, C35, C43, C43-2, C43ALTA, C43D, C48, C48-2, C48D, C48D-2, C48DDL, C48DL, C48E, C53, C53D, C6, C60, C60D, C6D, C98, CA55, CAP7, CR43, CR43D, CR48, CR48D, DP35, DP35-2, DP35D, DP40, DP40-2, DP40D, DP40-rib2, DP45, DP45D, DP50, DP50D, ED550, EDI5, GS-X1011, GS-X1011-2, GS-X1011-WEH, GS-X1011-WEH-2, GS-X1021, GS-X1021-2, GS-X1021-2rib, GS-X1021-WEH, GS-X1021-WEH-2, GS-X1021-WEH-2, GS-X1021-WEH-2rib...(Other models you can see in the webshop)		

<b>GEV No.</b>	359350	<b>Ref. No.</b>	34236
<b>description</b>	indicator light 230V blue connection male faston 6.3mm ø 11mm		
<b>For models:</b>	C35, C43, C43-2, C43ALTA, C43D, C48, C48-2, C48D, C48D-2, C48DDL, C48DL, C53, C53D, C6, C60, C60D, C6D, CDN3, CDN4, CR43, CR43D, CR48, CR48D, DP35, DP35-2, DP35D, DP35D-2, DP40, DP40-2, DP40D, DP40D-2, DP40D-rib2, DP40-rib2, DP45, DP45D, DP50, DP50D, SP35, SP35-2, SP35ALTA, SP35D, SP40, SP40-2, SP40D, SP40D-2, SP40DDL, SP40DL, SP45, SP45D, SP5...(Other models you can see in the webshop)		
<b>accessories for</b>	359350		
	<b>GEV No.</b>	345601	<b>Ref. No.</b> 32891
	indicator lamp holder V ø 11mm		

### indicator lights 3-piece (housing, lens and bulb)

#### lamps

#### neon light bulbs

<b>GEV No.</b>	359000	<b>Ref. No.</b>	130138 26929 H130138
<b>description</b>	neon light bulb socket Ba9s 24V 3W clear ø 10mm L 24mm		
<b>For models:</b>	AC151, AC181, AC201, AC241, EDT140, EDT170, EDT200, EDT230		
<b>accessories for</b>	359000		
	<b>GEV No.</b>	359060	<b>Ref. No.</b> —
	lamp socket mounting measurements ø16.2mm socket E10 connection screw		
	<b>GEV No.</b>	359063	<b>Ref. No.</b> —
	lamp socket mounting measurements ø19.2mm socket E14 connection screw		
	<b>GEV No.</b>	359064	<b>Ref. No.</b> —
	lamp socket mounting measurements ø22.3mm socket E14 connection screw 250/380V ambient temperature at 1W 100°C ambient temperature at 2W 85°C		
	<b>GEV No.</b>	359685	<b>Ref. No.</b> —
	lamp socket mounting measurements ø16.2mm socket E10		
	<b>GEV No.</b>	359832	<b>Ref. No.</b> —
	lamp socket mounting measurements ø16.2mm socket Ba9s connection male faston 6.3mm		



Table continues overleaf



Зип Общепит

vsezip.ru

+7(812)987-08-81

<b>accessories for</b>	359000		
	<b>GEV No.</b>	359853	<b>Ref. No.</b> —
	lamp socket mounting measurements ø18.2mm socket Ba9s connection male faston 6.3mm		
	<b>GEV No.</b>	359988	<b>Ref. No.</b> —
	lamp socket mounting measurements ø30.5mm 250V connection F6.3 temp.-resist. 55°C E14		

<b>GEV No.</b>	345927	<b>Ref. No.</b>	28789
<b>description</b>	indicator light housings mounting measurements 28.5x28.5mm red level		
<b>For models:</b>	CM43, CM48, E36, E40, E40-2F, E43, K80F, K80G, NK43, NK48, T3-80, T4-80, T5-80		

indicator lights (complete)

ø13mm

with plug-in socket

	1		
<b>GEV No.</b>	359142	<b>Ref. No.</b>	30844
<b>description</b>	indicator light ø 13mm green 230V connection male faston 6.3mm temp.-resist. 120°C Qty 1 pcs		
<b>For models:</b>	BPN48, BPS43, BPS52, ED630-90, UNI43C, UNI43R, UNI43RD, UNI48C, UNI48CD, UNI48R, UNI48RD, UNI53C, UNI53R, UNI53RD, UNI60C		

	1		
<b>GEV No.</b>	359800	<b>Ref. No.</b>	29665
<b>description</b>	indicator light housings mounting measurements 28.5x28.5mm green		
<b>For models:</b>	INDY43F, INDY48F, INDY53F, INDY60F		

	1		
<b>GEV No.</b>	359141	<b>Ref. No.</b>	25478
<b>description</b>	indicator light ø 13mm red 230V connection male faston 6.3mm temp.-resist. 120°C Qty 1 pcs		
<b>For models:</b>	BPN48, BPS43, BPS52, E36, E40, E43, E50, ED600-95, ED630-90, ED650E, ED650E-90, ED650S, ED650S-90, ED700-90, ED900-90, LO122, LO60, LO78, M60, T6-80, UNI43C, UNI43R, UNI43RD, UNI48C, UNI48CD, UNI48R, UNI48RD, UNI53C, UNI53R, UNI53RD, UNI60C		

	1		
<b>GEV No.</b>	359799	<b>Ref. No.</b>	29012
<b>description</b>	indicator light housings mounting measurements 28.5x28.5mm red		
<b>For models:</b>	CM48, CM52, INDY43F, INDY48F, INDY53F, INDY60F, TS43, TS48		

	1		
<b>GEV No.</b>	359143	<b>Ref. No.</b>	25479 25480
<b>description</b>	indicator light ø 13mm yellow 230V connection male faston 6.3mm temp.-resist. 120°C Qty 1 pcs		
<b>For models:</b>	BPN48, BPS43, BPS52, E36, E40, E43, E50, ED630-90, ED650E, ED650E-90, ED650S, ED650S-90, M60, T6-80, UNI43C, UNI43R, UNI43RD, UNI48C, UNI48CD, UNI48R, UNI48RD, UNI53C, UNI53R, UNI53RD, UNI60C		

	1		
<b>GEV No.</b>	359798	<b>Ref. No.</b>	29011
<b>description</b>	indicator light housings mounting measurements 28.5x28.5mm yellow		
<b>For models:</b>	CM48, CM52, CMD43, CMD52, INDY43F, INDY48F, INDY53F, INDY60F, TS43, TS48		

screw-on/push-on fit

neon light bulbs

28.5x28.5mm

	1		
<b>GEV No.</b>	345926	<b>Ref. No.</b>	28788
<b>description</b>	indicator light housings mounting measurements 28.5x28.5mm orange connection cycle		
<b>For models:</b>	CM43, CM48, CM52, CMD43, CMD48, CMD52, CMD60, E36, E40, E40-2F, E43, E50, K80F, K80G, NK43, NK48, NK52, NK60, NKD43, NKD48, NKD52, NKD60, T3-80, T4-80, T5-80		









	1		
<b>GEV No.</b>	359000	<b>Ref. No.</b>	130138 26929 H130138
<b>description</b>	neon light bulb socket Ba9s 24V 3W clear ø 10mm L 24mm		
<b>For models:</b>	AC151, AC181, AC201, AC241, EDT140, EDT170, EDT200, EDT230		
<b>accessories for</b>	359000		
	<b>GEV No.</b>	359060	<b>Ref. No.</b> —
	lamp socket mounting measurements ø16.2mm socket E10 connection screw		
	<b>GEV No.</b>	359063	<b>Ref. No.</b> —
	lamp socket mounting measurements ø19.2mm socket E14 connection screw		

Table continues overleaf



electric components





accessories for		359000	
	GEV No.	359064	Ref. No. —
	lamp socket mounting measurements ø22.3mm socket E14 connection screw 250/380V ambient temperature at 1W 100°C ambient temperature at 2W 85°C		
	GEV No.	359685	Ref. No. —
	lamp socket mounting measurements ø16.2mm socket E10		
	GEV No.	359832	Ref. No. —
	lamp socket mounting measurements ø16.2mm socket Ba9s connection male faston 6.3mm		
	GEV No.	359853	Ref. No. —
	lamp socket mounting measurements ø18.2mm socket Ba9s connection male faston 6.3mm		
	GEV No.	359988	Ref. No. —
	lamp socket mounting measurements ø30.5mm 250V connection F6.3 temp.-resist. 55°C E14		

## timers

## programme timers



			
1			
<b>GEV No.</b>	360038	<b>Ref. No.</b>	25389
<b>description</b>	timer CDC 4803F engines 1 chambers 3 operation time 120s 230V manuf. no. 4803F1 / 360038 motor type M48R ATS		
<b>spare parts for</b>	360038		
	GEV No.	360118	Ref. No. —
	motor CDC pinion ø 4.9mm teeth 10 230V voltage AC 50/60Hz turn direction right motor ø 47mm H 19.3mm motor type M48R ATS for timer cable length 260mm 1.9/2.5W		



			
1			
<b>GEV No.</b>	360037	<b>Ref. No.</b>	25392
<b>description</b>	timer CDC 4803F engines 1 chambers 3 operation time 180s 230V manuf. no. 4803F3 / 360037 motor type M48R ATS		
<b>For models:</b>	M60, T6-80		
<b>spare parts for</b>	360037		
	GEV No.	360118	Ref. No. —
	motor CDC pinion ø 4.9mm teeth 10 230V voltage AC 50/60Hz turn direction right motor ø 47mm H 19.3mm motor type M48R ATS for timer cable length 260mm 1.9/2.5W		

Зип Общежит

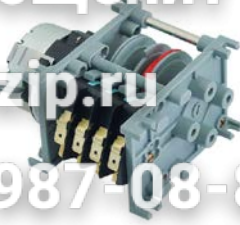
vsezip.ru

+7(812)987-08-81

			
1			
<b>GEV No.</b>	360310	<b>Ref. No.</b>	29828
<b>description</b>	timer CDC 4804M engines 1 chambers 4 operation time 120s 230V shaft ømm shaft Lmm manuf. no. 4804M1 / 29828 motor type M48R ATS		
<b>For models:</b>	ED650E, ED650E-90		
<b>spare parts for</b>	360310		
	GEV No.	360118	Ref. No. —
	motor CDC pinion ø 4.9mm teeth 10 230V voltage AC 50/60Hz turn direction right motor ø 47mm H 19.3mm motor type M48R ATS for timer cable length 260mm 1.9/2.5W		

			
1			
<b>GEV No.</b>	360035	<b>Ref. No.</b>	25381 31882
<b>description</b>	timer CDC 4902F engines 1 chambers 2 operation time 120s 230V shaft ø 6x4.6mm shaft L 17mm manuf. no. 4902F1 / 3322050 motor type M48L ATS		
<b>For models:</b>	E36, E40, E43, E50		
<b>spare parts for</b>	360035		
	GEV No.	360083	Ref. No. —
	motor CDC pinion ø 4.9mm teeth 10 230V turn direction left motor ø 47mm H 19.3mm motor type M48L ATS for timer		

			
1			
<b>GEV No.</b>	360493	<b>Ref. No.</b>	25404
<b>description</b>	timer CDC 6005F engines 1 chambers 5 operation time 90s 230V 50/60Hz motor type M48R ATS		
<b>For models:</b>	ED600-95, ED700, ED700-90, ED900, ED900-90, LO122, LO60, LO78		

Зип Общежит

vsezip.ru

+7(812)987-08-81



1

<b>GEV No.</b>	360311	<b>Ref. No.</b>	32529
<b>description</b>	timer CDC 7003F engines 1 chambers 3 operation time 6min 230V shaft ø 6x4.6mm shaft L 22mm manuf. no. 7003F3/32529 motor type M37LN		
<b>For models:</b>	UNI43C, UNI43R, UNI43RD, UNI48C, UNI48CD, UNI48R, UNI48RD, UNI53C, UNI53R, UNI53RD, UNI60C		
<b>spare parts for</b>	360311		
	<b>GEV No.</b>	360131	<b>Ref. No.</b> —
	motor CDC pinion ø 5.4mm teeth 12 230V turn direction left motor ø 37mm motor type M37LN for timer		



1

<b>GEV No.</b>	360308	<b>Ref. No.</b>	26880
<b>description</b>	timer CDC 7803 engines 1 chambers 3 operation time 18min 230V shaft ømm shaft Lmm manuf. no. 7803F1 / 26880 motor type M37RN		
<b>For models:</b>	C43-2, C43D, C48-2, C48D, C48D-2, C48DDL, C53D, C60D, C6D, CDN3, CDN4, CMD43, CMD48, CMD52, CR43D, CR48D, DP35D, DP35D-2, DP40D, DP40D-2, DP40D-rib2, DP45D, DP50D, NKD43, RSP40A, RSP50A, SP35-2, SP35D, SP40-2, SP40D, SP40D-2, SP40DDL, SP45D, SP50D, SP5D, SPR36D, SPR41D, STS43D, STS43D-2, STS48D, STS48D-2, STS48D-rib2, STS53D, STS60D, TDN4-2rib, TN-TDN5, TN-TDN6, UNI43RD, UNI48CD, UNI48RD...(Other models you can see in the webshop)		
<b>spare parts for</b>	360308		
	<b>GEV No.</b>	360119	<b>Ref. No.</b> —
	motor CDC pinion ø 5.4mm teeth 12 230V turn direction right motor ø 37mm motor type M37RN for timer		



1

<b>GEV No.</b>	360092	<b>Ref. No.</b>	30347
<b>description</b>	timer CDC 7803 engines 1 chambers 3 operation time 120s 230V shaft ømm shaft Lmm manuf. no. 7803F1 / 360092 motor type M37RN		
<b>For models:</b>	C3, C4, C43, C43ALTA, C43D, C48, C48D, C48DDL, C48DL, C53, C53D, C60, C60D, CR43, CR43D, CR48, CR48D, DP35, DP35D, DP40, DP40D, DP45, DP45D, DP50, DP50D, E40-2F, INDY43F, INDY48F, INDY53F, INDY60F, SP35, SP35ALTA, SP35D, SP40, SP40D, SP40DDL, SP40DL, SP45, SP45D, SP50, SP50-400V, SP50-440V, SP50D, SPR36, SPR36D, SPR41, SPR41D, STS43, STS43D, STS48...(Other models you can see in the webshop)		
<b>spare parts for</b>	360092		
	<b>GEV No.</b>	360119	<b>Ref. No.</b> —
	motor CDC pinion ø 5.4mm teeth 12 230V turn direction right motor ø 37mm motor type M37RN for timer		



1

<b>GEV No.</b>	360574	<b>Ref. No.</b>	31577
<b>description</b>	timer CDC 7804 engines 1 chambers 4 operation time 180s 230V 50Hz shaft ømm shaft Lmm motor type M37RN voltage AC		



1

<b>GEV No.</b>	360684	<b>Ref. No.</b>	34402
<b>description</b>	timer CDC 7804F1 / 34402 engines 1 chambers 4 operation time 120s 230V shaft ømm shaft Lmm manuf. no. 7804F10ADE000.0030		
<b>For models:</b>	C35, C43, C43-2, C43ALTA, C43D, C48, C48-2, C48D, C48D-2, C48DDL, C48DL, C53, C53D, C60, C60D, CDN3, CDN4, CR43, CR43D, CR48, CR48D, DP35, DP35-2, DP35D, DP35D-2, DP40, DP40-2, DP40D, DP40D-2, DP40D-rib2, DP40-rib2, DP45, DP45D, DP50, DP50D, RSP40, RSP40A, RSP50, RSP50A, SP35, SP35-2, SP35ALTA, SP35D, SP40, SP40-2, SP40D, SP40D-2, SP40DDL, SP40DL, SP45...(Other models you can see in the webshop)		

Зип Общепит

vsezip.ru

+7(812)987-08-81



1

<b>GEV No.</b>	360040	<b>Ref. No.</b>	25386
<b>description</b>	timer CDC 9003F engines 1 chambers 3 operation time 6min 230V shaft ø 6x4.6mm shaft L 21mm manuf. no. 9003F3 / PRCIH5 motor type M48R ATS		
<b>For models:</b>	NK43, NK48, NK52, NK60, NKD43, NKD48, NKD52, NKD60, T3-80, T4-80		
<b>spare parts for</b>	360040		
	<b>GEV No.</b>	360118	<b>Ref. No.</b>
			—
	motor CDC pinion ø 4.9mm teeth 10 230V voltage AC 50/60Hz turn direction right motor ø 47mm H 19.3mm motor type M48R ATS for timer cable length 260mm 1.9/2.5W		
<b>accessories for</b>	360040		
	<b>GEV No.</b>	110197	<b>Ref. No.</b>
			25095
	knob switch zero mark ø 42mm shaft ø 6x4.6mm shaft flat adjustable black		



1

<b>GEV No.</b>	360448	<b>Ref. No.</b>	31882
<b>description</b>	timer FIBER P26 engines 1 chambers 3 operation time 120s 230V manuf. no. P265J03H313 motor type M61B40L0000		



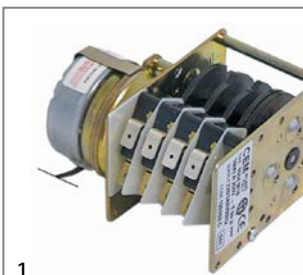

1

<b>GEV No.</b>	360086	<b>Ref. No.</b>	34402 old version
<b>description</b>	timer FIBER P26 engines 1 chambers 4 operation time 120s 230V shaft ømm shaft Lmm manuf. no. P265J04H315 motor type M61B40R6400		



1

<b>GEV No.</b>	360043	<b>Ref. No.</b>	H120262
<b>description</b>	timer CEM HH4M16 engines 1 chambers 4 operation time 120s 230V shaft ømm shaft Lmm manuf. no. HH4M16 / 120262 motor type UDS11NE1RH		
<b>spare parts for</b>	360043		
	<b>GEV No.</b>	360112	<b>Ref. No.</b>
			—
	motor SAIA pinion ø 4mm teeth 12 230V turn direction right motor ø 48mm motor type UDS11NE1RHZ for timer		





1

<b>GEV No.</b>	360306	<b>Ref. No.</b>	32361
<b>description</b>	timer FIBER P26 engines 1 chambers 6 operation time 150s 230V shaft ømm shaft Lmm manuf. no. P265J06H427 motor type M61B40R6400		
<b>For models:</b>	APS43, APS48, APS53, APS60, FW35, FW40, FW45, FW50		



1

<b>GEV No.</b>	360093	<b>Ref. No.</b>	31054
<b>description</b>	timer FIBER P25 engines 2 chambers 5 operation time 40s / 3min 230V manuf. no. P255J05JKL0 motor type M51BJ0R6400 / M51B-J0L6400		
<b>For models:</b>	CM48, CM52, CMD43, CMD52, ED630-90, ED650S-90, TS43, TS48		
<b>spare parts for</b>	360093		
	<b>GEV No.</b>	360673	<b>Ref. No.</b>
			—
	motor kit pinion ø 6.8mm teeth 15 230V voltage AC 50/60Hz turn direction clockwise motor ø 48mm H 18.5mm motor type UDS-40NE1RNZ165 cable length 150mm with holder		
	<b>GEV No.</b>	360674	<b>Ref. No.</b>
			—
	motor kit pinion ø 6.8mm teeth 15 230V voltage AC 50/60Hz turn direction counterclockwise motor ø 48mm H 18.5mm motor type UDS40NE1RNZ165 cable length 150mm with holder		



1

<b>GEV No.</b>	360307	<b>Ref. No.</b>	32362
<b>description</b>	timer FIBER P26 engines 1 chambers 6 operation time 180s 230V shaft ømm shaft Lmm manuf. no. P265J06H528 motor type M61B40R6400		
<b>For models:</b>	APS43, APS48, APS53, APS60, FW35, FW40, FW45, FW50		





Зип Общежит

contactors

vsezip.ru

+7(812)987-08-81



1

<b>GEV No.</b>	360626	<b>Ref. No.</b>	31577
<b>description</b>	timer FIBER P265J04H571 engines 1 chambers 4 operation time 180s 230V 50Hz shaft ømm shaft Lmm voltage AC		
<b>For models:</b>	C6, C6D, SP5, SP5D		



1

<b>GEV No.</b>	360036	<b>Ref. No.</b>	25384
<b>description</b>	timer FIBER P39 engines 1 chambers 3 operation time 120s 230V shaft ø 6x4.6mm shaft L 16mm manuf. no. P395J03H301 motor type M51BJ0L6400		
<b>For models:</b>	CM43, CM48, CM52, CMD43, CMD48, CMD52, CMD60, K80F, K80G		
<b>spare parts for</b>	360036		
	<b>GEV No.</b>	360674	<b>Ref. No.</b> —
	motor kit pinion ø 6.8mm teeth 15 230V voltage AC 50/60Hz turn direction counterclockwise motor ø 48mm H 18.5mm motor type UDS40NE1RNZ165 cable length 150mm with holder		

digital timers



1

<b>GEV No.</b>	400945	<b>Ref. No.</b>	120226
<b>description</b>	timer electronic		

GENERAL ELECTRIC (AEG)

power contactors



1

<b>GEV No.</b>	380239	<b>Ref. No.</b>	25505 29807 31873 31982
<b>description</b>	power contactor resistive load 20A 230VAC (AC3/400V) 8.4A/4kW main contacts 3NO auxiliary contacts 1NC connection screw connection type LS05 01A type AEG LS05 01A type GE MC1A 301A		
<b>For models:</b>	60BT, 60BT-3, 60EBT, AP43E, AP48E, AP53E, AP60E, APS43, APS48, APS48B, APS53, APS60, APSE43, APSE48, APSE53, APSE60, BPN48, BPS43, BPS52, C43, C43ALTA, C48, C48D, C48DDL, C48DL, C53, C53D, C53DE, C53E, C60, C60D, C60DE, C60E, C68DE, C68E, C68EBT, C6EBT, C81, C81E, C81EBT, C90, C90DE, C90DE2, C90E, C90E2, C90EBT, C90EBT2, C98, CA120, CA55...(Other models you can see in the webshop)		



1

<b>GEV No.</b>	380238	<b>Ref. No.</b>	25506
<b>description</b>	power contactor resistive load 20A 230VAC (AC3/400V) 8.4A/4kW main contacts 3NO auxiliary contacts 1NO connection screw connection type LS0510A type AEG LS0510A type GE MC1A 310A		
<b>For models:</b>	ED650E, ED650E-90, T6-80		



1

<b>GEV No.</b>	380262	<b>Ref. No.</b>	31981
<b>description</b>	power contactor resistive load 32A 230VAC (AC3/400V) 17A/7.5kW main contacts 3NO auxiliary contacts 1NC connection screw connection type AEG LS7K01A type GE CL02A 301 H 85mm		
<b>For models:</b>	CA120, CA90, CAP10BT, ED600-95, ED650E, ED650S, ED700-90, ED900-90, EDI13, EDI13-2, EDI13ALTA, EDI13ALTA-2, EDI13ALTABT, EDI13BT, EDI4, EDI6, EDI6-2, EDI6BT, EDI8, EDI8-2, EDI8BT, LO122, LO134, LO134-2, LO134ALTA, LO134ALTA-2, LO56, LO60, LO67, LO67-2, LO78, LO83, LO83-2, RLO200, RLO300, RLO400		

electric components

Зип Общепит

vsezip.ru

+7(812)987-08-81



<b>GEV No.</b>	380261	<b>Ref. No.</b>	25501
<b>description</b>	power contactor resistive load 32A 230VAC (AC3/400V) 17A/7.5kW main contacts 3NO auxiliary contacts 1NO connection screw connection type AEG LS7K 10A type GE CL02A 310		
<b>For models:</b>	ED630-90, ED650E, ED650E-90, ED650S-90		



<b>GEV No.</b>	380626	<b>Ref. No.</b>	29839
<b>description</b>	power relays FINDER 230VAC 10A 2CO connection male faston 4.8mm bracket mounting manuf. no. 62.62.8.230.0000		
<b>For models:</b>	APS43, APS48, APS53, APS60, FW35, FW40, FW45, FW50		

ISKRA (FANAL)

power contactors



<b>GEV No.</b>	380212	<b>Ref. No.</b>	H120461
<b>description</b>	power contactor resistive load 20A 230VAC (AC3/400V) 8.5A/5.5kW main contacts 3NO auxiliary contacts 1NC connection screw connection type Fanal K07M 01 type ISKRA DSL7 01		

relay sockets



<b>GEV No.</b>	380137	<b>Ref. No.</b>	27193
<b>description</b>	relay socket 8-pole connection plug-in connection round 8-pole dimensions 65x28x40mm 380V voltage AC 10A Italiana Relè manuf. no. ZVE8		
<b>For models:</b>	APS43, APS48, APS53, APS60, BPS43, ED600-95, ED630-90, ED650S, ED650S-90, ED700-90, ED900-90, FW35, FW40, FW45, FW50, LO122, LO60, LO78		
<b>accessories for</b>	380137		
	<b>GEV No.</b>	380805	<b>Ref. No.</b> —
	support bracket		

relays

power relays

with bracket mounting



<b>GEV No.</b>	380627	<b>Ref. No.</b>	33324 34312
<b>description</b>	power relays 230VAC 16A 2CO connection male faston bracket mounting		
<b>For models:</b>	60EBT, APS43, APS48, APS53, APS60, C35, C43, C43-2, C43ALTA, C43D, C48, C48-2, C48D, C48D-2, C48DDL, C48DL, C53, C53D, C6, C60, C60D, C68EBT, C6D, CA55, CAP7, CDN3, CDN4, CR43, CR43D, CR48, CR48D, DP35, DP35-2, DP35D, DP35D-2, DP40, DP40-2, DP40D, DP40D-2, DP40D-rib2, DP40-rib2, DP45, DP45D, DP50, DP50D, ED550, FW35, FW40, FW45, FW50...(Other models you can see in the webshop)		

level relays

GICAR



<b>GEV No.</b>	400048	<b>Ref. No.</b>	27434
<b>description</b>	level relay 1CO 230V voltage AC connection plug-in connection round 8-pole type 27434		
<b>For models:</b>	APS43, APS48, APS53, APS60, ED600-95, ED630-90, ED650S, ED650S-90, ED700-90, ED900-90, FW35, FW40, FW45, FW50, LO122, LO60, LO78		



pulse relays

Зип Общепит

vsezip.ru

+7(812)987-08-81

			
1			
<b>GEV No.</b>	381195	<b>Ref. No.</b>	120493 H120493
<b>description</b>	pulse relay voltage AC/DC 1CO 250V 16A connection screw clamp DIN rail		
<b>For models:</b>	HT100, HT150, HTP195, HTP205, HTP220, TR100, TR230, TR90, TR-E100, TR-E150, TR-E200, TR-E230, TR-E90		

			
1			
<b>GEV No.</b>	379908	<b>Ref. No.</b>	33174
<b>description</b>	temperature probe NTC		
<b>For models:</b>	APSE43, APSE48, APSE53, APSE60, C81, C90, CA120, CA90, ED650E, ED650S, EDI13, EDI13ALTA, EDI6, EDI8, LO134, LO134ALTA, LO50, LO67, LO83, SP81, US-X501		

time relays



time relays

			
1			
<b>GEV No.</b>	360465	<b>Ref. No.</b>	25408
<b>description</b>	time relay FIBER T45 time range 0s-120h 230VAC 5/2A mounting measurements 45x45mm 2CO		
<b>For models:</b>	ED600-95, ED700, ED700-90, ED900, ED900-90, LO122, LO60, LO78		
<b>accessories for</b>	360465		
	<b>GEV No.</b>	360485	<b>Ref. No.</b>
	 mounting frame L 72mm W 72mm for time relay for model E47,E48,E58,E59,T45,C58,C59		

			
1			
<b>GEV No.</b>	378006	<b>Ref. No.</b>	120960 34945 35567
<b>description</b>	temperature probe NTC 40kOhm cable PVC probe -40 up to +110°C cable -10 up to 100°C connection F6.3 thread probe ø4x20mm cable length 0.25m		
<b>For models:</b>	AP43E, AP48E, AP53E, AP60E, APS43, APS48, APS48B, APS53, APS60, C81, C81E, C81EBT, C90, C90DE, C90DE2, C90E, C90E2, C90EBT, C90EBT2, CA120, CA90, CAP10, CAP10BT, CAP10DE, CAP12, CAP12DE, CAP12EBT, CAP7E, DP45DE, DP45E, DP50DE, DP50E, DP50EBT, ED650E, ED650S, EDI13, EDI13-2, EDI13ALTA, EDI13ALTA-2, EDI13AL-TABT, EDI13BT, EDI4, EDI6, EDI6-2, EDI6BT, EDI8, EDI8-2, EDI8BT, FW35, FW35E...(Other models you can see in the webshop)		

electronics



EPROMS

 Image not available			
1			
<b>GEV No.</b>	401887	<b>Ref. No.</b>	35562
<b>description</b>	micro processor CODE DWSAP240203		
<b>For models:</b>	APS43, APS48, APS48B, APS53, APS60, FW35, FW40, FW40B, FW45, FW50		
			
1			
<b>GEV No.</b>	402840	<b>Ref. No.</b>	35565
<b>description</b>	micro processor suitable for HOONVED CODE DWEDCAP 031002		
<b>For models:</b>	CA120, CA90, ED650E, ED650S		

probes

producer-specific probes

probes

			
1			
<b>GEV No.</b>	380938	<b>Ref. No.</b>	H120910
<b>description</b>	probe Pt100 cable silicone probe -100 up to 450°C cable -50 up to +180°C connection plug thread 1/2" probe ø6x70mm cable length 6.5m		
<b>accessories for</b>	380938		
	<b>GEV No.</b>	510355	<b>Ref. No.</b>
	 gasket fibre ED ø 24mm ID ø 17mm thickness 2mm Qty 1 pcs		



## PCBs

Зип Общепит

vsezip.ru

+7(812)987-08-81



1	<b>GEV No.</b>	403730	<b>Ref. No.</b>	37676
	<b>description</b>	control PCB L 175mm W 30mm		
	<b>For models:</b>	CAP7E, SO55E		



1	<b>GEV No.</b>	402929	<b>Ref. No.</b>	121306 37576
	<b>description</b>	display PCB dishwasher DP45/50 L 85mm W 28mm green 4 digits		
	<b>For models:</b>	CAP7E, DP45DE, DP45E, DP50DE, DP50E, DP50EBT, ST43DE, ST43E, ST48DE, ST48E, ST48EBT, ST53DE, ST53E, ST60DE, ST60E, ST60EBT		



1	<b>GEV No.</b>	402805	<b>Ref. No.</b>	36490
	<b>description</b>	keypad PCB dishwasher 60EBT/C43DE buttons 3		
	<b>For models:</b>	60EBT, C43DE, C43E, C46DE, C46E, C53DE, C53E, C60DE, C60E, C68DE, C68E, C68EBT, C6DE, C6E, C6EBT, SP35DE, SP35E, SP40DE, SP40E, SP45DE, SP45E, SP50DE, SP50E, SP50E-400V3-50Hz-MARINE, SP50E-440V3-60Hz-MARINE, SP5DE, SP5E, SP68DE, SP68E		
	<b>accessories for</b>	402805		
		<b>GEV No.</b>	<b>Ref. No.</b>	110492 110498 36492
	ribbon cable 10-pole L 500mm plug type FC-10P raster size 2.54mm			



1	<b>GEV No.</b>	402908	<b>Ref. No.</b>	36339
	<b>description</b>	keypad PCB dishwasher C81/90 suitable for HOONVED with display buttons 4		
	<b>For models:</b>	C81E, C90DE, C90E, C90EBT, CAP10, CAP10BT, CAP12, LO50E, SMW15E, SO100, SO100-400V3-50Hz-MARINE, SO100-440V3-60Hz-MARINE, SO120, SP81E		



1	<b>GEV No.</b>	402928	<b>Ref. No.</b>	121305 37575
	<b>description</b>	keypad unit L 170mm W 28mm with LED buttons 4		
	<b>For models:</b>	DP45DE, DP45E, DP50DE, DP50E, ST43DE, ST43E, ST48DE, ST48E, ST53DE, ST53E, ST60DE, ST60E, ST60EBT		



1	<b>GEV No.</b>	400944	<b>Ref. No.</b>	121237 H121237
	<b>description</b>	PCB		
	<b>For models:</b>	GS-X1011, GS-X1011-2, GS-X1011-WEH, GS-X1011-WEH-2, GS-X1021, GS-X1021-2, GS-X1021-2rib, GS-X1021-WEH, GS-X1021-WEH-2, GS-X1021-WEH-2rib		



1	<b>GEV No.</b>	400950	<b>Ref. No.</b>	34514
	<b>description</b>	PCB		
	<b>For models:</b>	CA120, CA90, ED650E, ED650S		



1	<b>GEV No.</b>	400951	<b>Ref. No.</b>	33173
	<b>description</b>	PCB		
	<b>For models:</b>	APS43, APS48, APS48B, APS53, APS60, APSE43, APSE48, APSE53, APSE60, C81, FW35, FW40, FW40B, FW45, FW50, SP81		

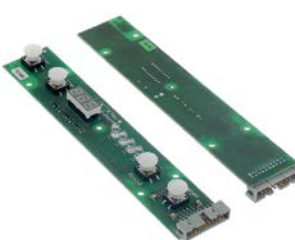

1	<b>GEV No.</b>	698575	<b>Ref. No.</b>	H121300
	<b>description</b>	PCB dishwasher AP43/48-FW35/40E L 184mm W 34mm		
	<b>For models:</b>	AP43E, AP48E, AP53E, AP60E, C81E, C90DE2, C90EBT2, CAP10, CAP10BT, CAP12, FW35E, FW40E, SO100, SO120		



Зип Общепит

vsezip.ru

+7(812)987-08-81



1

<b>GEV No.</b>	401902	<b>Ref. No.</b>	H121291
<b>description</b>	PCB dishwasher BAC30E		
<b>For models:</b>	60EBT, C43DE, C43E, C46DE, C46E, C53DE, C53E, C60DE, C60E, C68DE, C68E, C68EBT, C6DE, C6E, SP35DE, SP35E, SP40DE, SP40E, SP45DE, SP45E, SP50DE, SP50E, SP50E-400V3-50Hz-MARINE, SP50E-440V3-60Hz-MARINE, SP5DE, SP5E, SP68DE, SP68E		



1

<b>GEV No.</b>	402881	<b>Ref. No.</b>	121284 H121284
<b>description</b>	PCB dishwasher CE-GE L 126mm W 63mm suitable for COMENDA		



1

<b>GEV No.</b>	402864	<b>Ref. No.</b>	37949
<b>description</b>	PCB dishwasher C35E L 85mm W 70mm model since February 2013 type 8.5.65.99		
<b>For models:</b>	C35E, SPB35E		



1

<b>GEV No.</b>	401846	<b>Ref. No.</b>	H121287
<b>description</b>	PCB dishwasher COMENDA, HOONVED		
<b>For models:</b>	C48E, CAP7, SO55, SO55-400V3-50Hz-MARINE, SO55-440V3-60Hz-MARINE, SP40E		



1

<b>GEV No.</b>	400943	<b>Ref. No.</b>	121239 H121239
<b>description</b>	PCB dishwasher C75/C155		
<b>For models:</b>	60BT, 60BT-3, SD5BT		



1

<b>GEV No.</b>	402926	<b>Ref. No.</b>	121307 37577 37904 H37904
<b>description</b>	PCB dishwasher DP40/DP45 L 100mm W 100mm for dishwasher		
<b>For models:</b>	DP45DE, DP45E, DP50DE, DP50E, ST43DE, ST43E, ST48DE, ST48E, ST53DE, ST53E, ST60DE, ST60E, ST60EBT		



1

<b>GEV No.</b>	403763	<b>Ref. No.</b>	121322
<b>description</b>	PCB dishwasher CAP7E/SO55E L 100mm W 100mm		
<b>For models:</b>	CAP7E		



1

<b>GEV No.</b>	402695	<b>Ref. No.</b>	H121283
<b>description</b>	PCB dishwasher L 145mm W 105mm HOONVED		
<b>For models:</b>	C81E, C90DE, C90DE2, C90E, C90EBT, C90EBT2, CAP10, CAP10BT, CAP12, EDI13-2, EDI13ALTA-2, EDI13ALTABT, EDI13BT, EDI4, EDI6-2, EDI6BT, EDI8-2, EDI8BT, LO134-2, LO134ALTA-2, LO50E, LO56, LO67-2, LO83-2, SMW15E, SO100, SO100-400V3-50Hz-MARINE, SO100-440V3-60Hz-MARINE, SO120, SP81E		

electric components



Зип.Общепит

solenoid valves  
vsezip.ru

+7(812)987-08-81



1

<b>GEV No.</b>	403272	<b>Ref. No.</b>	34842
<b>description</b>	PCB for dishwasher EDI13 L 145mm W 95mm Qty 1 pcs		
<b>For models:</b>	EDI13, EDI13ALTA, EDI6, EDI8, LO134, LO134ALTA, LO67, LO83, RLO200, RLO300, RLO400		



1

<b>GEV No.</b>	403049	<b>Ref. No.</b>	35785
<b>description</b>	PCB L 145mm W 95mm 230V without EPROM		
<b>For models:</b>	C90, LO50, RLO50, SMW15		



1

<b>GEV No.</b>	403274	<b>Ref. No.</b>	38062
<b>description</b>	PCB warewashing CAP7E/SO55E L 100mm W 100mm Qty 1 pcs		
<b>For models:</b>	CAP7E, SO55E		

## keypads

## front foils



1

<b>GEV No.</b>	403328	<b>Ref. No.</b>	33713
<b>description</b>	front foil dishwasher C43 suitable for HOONVED L 420mm W 45mm		
<b>For models:</b>	C43, C43-2, C43ALTA, C43D, C48DDL, C48DL, C53D, CR43, CR43D, CR48, SP35, SP35ALTA, SP35D, SP40DDL, SP40DL, SP45D, SPR36, SPR36D, SPR41		



1

<b>GEV No.</b>	402925	<b>Ref. No.</b>	36134 463298
<b>description</b>	keypad foil dishwasher 60EBT/C43DE blue suitable for HOONVED L 256mm W 37mm buttons 3		
<b>For models:</b>	60EBT, C43DE, C43E, C46DE, C46E, C53DE, C53E, C60DE, C60E, C68DE, C68E, C68EBT, C6DE, C6E, C6EBT, SP35DE, SP35E, SP40DE, SP40E, SP45DE, SP45E, SP50DE, SP50E, SP68DE, SP68E		

## solenoid valves (water)



1

<b>GEV No.</b>	370021	<b>Ref. No.</b>	26631
<b>description</b>	solenoid valve double straight 230VAC inlet 3/4" outlet 11.5mm DN10 TP flow regulating valve inlet white		
<b>For models:</b>	C43D, C43DE, C46DE, C46E, C48D, C48D-2, C48DDL, C48E, C53D, C53DE, C60D, C60DE, C68DE, C68E, C6D, C6DE, C90DE, C90DE2, CAP10DE, CAP12DE, CM43, CM48, CM52, CM60, CR43D, CR48D, DP35, DP35-2, DP35D, DP40, DP40-2, DP40D, DP40-rib2, DP45, DP45D, DP45DE, DP50, DP50D, DP50DE, E36, E40, E40-2F, E43, E50, GS-X1011, GS-X1011-2, GS-X1011-WEH, GS-X1011-WEH-2, GS-X1021, GS-X1021-2...(Other models you can see in the webshop)		

<b>spare parts for</b>	370021			
	<b>GEV No.</b>	371013	<b>Ref. No.</b>	—
	solenoid coil TP 230VAC 50/60Hz			

<b>accessories for</b>	370021		
------------------------	--------	--	--

	<b>GEV No.</b>	371220	<b>Ref. No.</b>	—
	reducer TP flow rate 3l/min red tolerance ±15%			

	<b>GEV No.</b>	371221	<b>Ref. No.</b>	—
	reducer TP flow rate 5.5l/min yellow tolerance ±15%			

	<b>GEV No.</b>	371222	<b>Ref. No.</b>	—
	reducer TP flow rate 6l/min grey tolerance ±15%			

	<b>GEV No.</b>	371223	<b>Ref. No.</b>	—
	reducer TP flow rate 10l/min white tolerance ±15%			

	<b>GEV No.</b>	371224	<b>Ref. No.</b>	—
	reducer TP flow rate 12l/min bronze tolerance ±15%			

	<b>GEV No.</b>	371225	<b>Ref. No.</b>	—
	reducer TP flow rate 16l/min light brown tolerance ±15%			

	<b>GEV No.</b>	371226	<b>Ref. No.</b>	—
	reducer TP flow rate 20l/min red tolerance ±15%			

	<b>GEV No.</b>	371230	<b>Ref. No.</b>	—
	reducer TP flow rate 0.25l/min red tolerance ±25%			

	<b>GEV No.</b>	371231	<b>Ref. No.</b>	—
	reducer TP flow rate 0.35l/min violet tolerance ±25%			

	<b>GEV No.</b>	371232	<b>Ref. No.</b>	—
	reducer TP flow rate 0.5l/min orange tolerance ±25%			

	<b>GEV No.</b>	371233	<b>Ref. No.</b>	—
	reducer TP flow rate 0.8l/min white tolerance ±25%			

Table continues overleaf



Зип-Общепит

vsezip.ru

+7(812)987-08-81

1 electric components

accessories for		370021	
GEV No.	Ref. No.	Ref. No.	
	371234	—	reducer TP flow rate 1l/min light blue tolerance ±25%
	371235	—	reducer TP flow rate 1.2l/min brown tolerance ±25%
	371236	—	reducer TP flow rate 1.5l/min light brown tolerance ±25%
	371237	—	reducer TP flow rate 2.5l/min yellow tolerance ±25%
	371238	—	reducer TP flow rate 3.4l/min dark green tolerance ±25%
	371239	—	reducer TP flow rate 5l/min black tolerance ±25%
	371240	—	reducer TP flow rate 8l/min blue tolerance ±20%

accessories for		370017	
GEV No.	Ref. No.	Ref. No.	
	371226	—	reducer TP flow rate 20l/min red tolerance ±15%
	371230	—	reducer TP flow rate 0.2l/min red tolerance ±25%
	371231	—	reducer TP flow rate 0.35l/min violet tolerance ±25%
	371232	—	reducer TP flow rate 0.5l/min orange tolerance ±25%
	371233	—	reducer TP flow rate 0.8l/min white tolerance ±25%
	371234	—	reducer TP flow rate 1l/min light blue tolerance ±25%
	371235	—	reducer TP flow rate 1.2l/min brown tolerance ±25%
	371236	—	reducer TP flow rate 1.5l/min light brown tolerance ±25%
	371237	—	reducer TP flow rate 2.5l/min yellow tolerance ±25%
	371238	—	reducer TP flow rate 3.4l/min dark green tolerance ±25%
	371239	—	reducer TP flow rate 5l/min black tolerance ±25%
	371240	—	reducer TP flow rate 8l/min blue tolerance ±20%

<p>1</p>			
<b>GEV No.</b>	370017	<b>Ref. No.</b>	26629
<b>description</b>	solenoid valve single straight 230VAC inlet 3/4" outlet 11.5mm DN10 TP p max 10bar		
<b>For models:</b>	60BT, 60BT-3, 60EBT, AP43E, AP48E, AP53E, AP60E, C3, C35, C35E, C4, C43, C43-2, C43ALTA, C43D, C43E, C46E, C48, C48-2, C48D, C48DDL, C48DL, C48E, C53, C53D, C53E, C6, C60, C60D, C60E, C68DE, C68E, C68EBT, C6D, C6E, CAP10BT, CR43, CR43D, CR48, CR48D, DP45E, DP50D-115V, DP50E, E36, ED650E, ED650E-90, ED650S, FW35E, FW40E, GS-X1011...(Other models you can see in the webshop)		
<b>spare parts for</b>	370017		
	GEV No.	371013	Ref. No. —
	solenoid coil TP 230VAC 50/60Hz		
<b>accessories for</b>	370017		
	GEV No.	371220	Ref. No. —
	reducer TP flow rate 3l/min red tolerance ±15%		
	GEV No.	371221	Ref. No. —
	reducer TP flow rate 5.5l/min yellow tolerance ±15%		
	GEV No.	371222	Ref. No. —
	reducer TP flow rate 6l/min grey tolerance ±15%		
	GEV No.	371223	Ref. No. —
	reducer TP flow rate 10l/min white tolerance ±15%		
	GEV No.	371224	Ref. No. —
	reducer TP flow rate 12l/min bronze tolerance ±15%		
	GEV No.	371225	Ref. No. —
	reducer TP flow rate 16l/min light brown tolerance ±15%		

<p>1</p>			
<b>GEV No.</b>	370015	<b>Ref. No.</b>	30933 30993 H120145
<b>description</b>	solenoid valve single angled 230VAC inlet 3/4" outlet 11.5mm DN10 TP		
<b>For models:</b>	APS43, APS48, APS48B, APS53, APS60, APSE43, APSE48, APSE53, APSE60, BPN48, BPS43, BPS52, C81, C81E, C81EBT, C90, C90E, C90E2, C90EBT, C90EBT2, CA120, CA55, CA90, CAP10, CAP12, CAP7, CAP7E, ED550, ED650E, ED650S, EDI4, FW35, FW40, FW40B, FW45, FW50, INDY48F, LO50, LO50E, LO56, RCA1100, RCA1200, RCA1200i, RLO50, SMW15, SMW15E, SO100, SO100-400V3-50Hz-MARINE, SO100-440V3-60Hz-MARINE, SO120...(Other models you can see in the webshop)		
<b>accessories for</b>	370015		
	GEV No.	371220	Ref. No. —
	reducer TP flow rate 3l/min red tolerance ±15%		

Table continues overleaf

Зип Общепит

vsezip.ru

+7(812)987-08-81





<b>GEV No.</b>	370023	<b>Ref. No.</b>	26632
<b>description</b>	solenoid valve triple angled 230VAC inlet 3/4" outlet 11.5mm DN10 TP		
<b>For models:</b>	CDN3, CDN4, CMD43, CMD48, CMD52, CMD60, DP35D, DP35D-2, DP40D, DP40D-2, DP40D-rib2, DP45D, DP50D, GS-X1021, GS-X1021-2, GS-X1021-2rib, GS-X1021-WEH, GS-X1021-WEH-2, GS-X1021-WEH-2rib, NKD43, NKD48, NKD60, STS43D, STS43D-2, STS48D, STS48D-2, STS48D-rib2, STS53D, STS60D, TDN4-2rib, TN-TDN5, TN-TDN6, UNI43RD, UNI48CD, UNI48RD, UNI53RD		
<b>spare parts for</b>	370023		
	<b>GEV No.</b>	371013	<b>Ref. No.</b>
			—
	solenoid coil TP 230VAC 50/60Hz		
<b>accessories for</b>	370023		
	<b>GEV No.</b>	371220	<b>Ref. No.</b>
			—
	reducer TP flow rate 3l/min red tolerance ±15%		
	<b>GEV No.</b>	371221	<b>Ref. No.</b>
			—
	reducer TP flow rate 5.5l/min yellow tolerance ±15%		
	<b>GEV No.</b>	371222	<b>Ref. No.</b>
			—
	reducer TP flow rate 6l/min grey tolerance ±15%		
	<b>GEV No.</b>	371223	<b>Ref. No.</b>
			—
	reducer TP flow rate 10l/min white tolerance ±15%		
	<b>GEV No.</b>	371224	<b>Ref. No.</b>
			—
	reducer TP flow rate 12l/min bronze tolerance ±15%		
	<b>GEV No.</b>	371225	<b>Ref. No.</b>
			—
	reducer TP flow rate 16l/min light brown tolerance ±15%		
	<b>GEV No.</b>	371226	<b>Ref. No.</b>
			—
	reducer TP flow rate 20l/min red tolerance ±15%		
	<b>GEV No.</b>	371230	<b>Ref. No.</b>
			—
	reducer TP flow rate 0.25l/min red tolerance ±25%		
	<b>GEV No.</b>	371231	<b>Ref. No.</b>
			—
	reducer TP flow rate 0.35l/min violet tolerance ±25%		
	<b>GEV No.</b>	371232	<b>Ref. No.</b>
			—
	reducer TP flow rate 0.5l/min orange tolerance ±25%		
	<b>GEV No.</b>	371233	<b>Ref. No.</b>
			—
	reducer TP flow rate 0.8l/min white tolerance ±25%		
	<b>GEV No.</b>	371234	<b>Ref. No.</b>
			—
	reducer TP flow rate 1l/min light blue tolerance ±25%		
	<b>GEV No.</b>	371235	<b>Ref. No.</b>
			—
	reducer TP flow rate 1.2l/min brown tolerance ±25%		

Table continues overleaf











Зип Общепит

vsezip.ru





+7(812)987-08-81

accessories for		370023	
	GEV No.	371236	Ref. No. —
reducer TP flow rate 1.5l/min light brown tolerance ±25%			
	GEV No.	371237	Ref. No. —
reducer TP flow rate 2.5l/min yellow tolerance ±25%			
	GEV No.	371238	Ref. No. —
reducer TP flow rate 3.4l/min dark green tolerance ±25%			
	GEV No.	371239	Ref. No. —
reducer TP flow rate 5l/min black tolerance ±25%			
	GEV No.	371240	Ref. No. —
reducer TP flow rate 8l/min blue tolerance ±20%			

			
1	GEV No.	370643	Ref. No. 25305
<b>description</b> solenoid valve 2-ways 230VAC inlet 3/4" outlet 3/4" L 100mm with flange slide-on receptacle DIN BÜRKERT membranes NBR p max 16bar p min 0.2bar 50/60Hz brass			
<b>For models:</b> ED600-95, ED630-90, ED700-90, EDI6, EDI6-2, LO60, LO67, LO67-2, RLO200			

solenoid valves with reducers			
			
1	GEV No.	370245	Ref. No. LF-3120530
<b>description</b> solenoid valve single straight 24VAC inlet 3/4" outlet 11.5mm input 16l/min t.max. 90°C TP plastic flow regulating valve inlet light brown			

metal			
BÜRKERT			
2-way			
6213 series			
			
1	GEV No.	370627	Ref. No. 27132
<b>description</b> solenoid valve 2-ways 230VAC connection 3/4" L 58mm DN 13mm slide-on receptacle DIN type series 6213 membranes NBR p max 10bar 50Hz brass			
<b>For models:</b> ED700-90, ED900-90, EDI13, EDI13-2, EDI13ALTA, EDI13ALTA-2, EDI8, EDI8-2, LO122, LO134, LO134-2, LO134ALTA, LO134ALTA-2, LO78, LO83, LO83-2, RLO300, RLO400			

SIRAI			
2-way			
L140-B series			
			
1	GEV No.	370320	Ref. No. 120141 H120141
<b>description</b> solenoid valve brass 2-ways 24VAC inlet 1/2" outlet 1/2" connection 1/2" L 41mm DN 10mm slide-on receptacle compact -10 up to +90°C SIRAI type series L140-B coil type Z610A membranes NBR (water) p max 12bar p min 0.35bar			
<b>For models:</b> AC101, AC151, AC181, AC201, AC241, AC91, EDT100, EDT140, EDT170, EDT200, EDT230, EDT85, TR100, TR140, TR170, TR200, TR230, TR90, TR-E100, TR-E150, TR-E170, TR-E200, TR-E230, TR-E90			
<b>spare parts for</b> 370320			
	GEV No.	371070	Ref. No. —
solenoid coil 24VAC 10VA SIRAI coil type Z610A seat ø 10mm			
	GEV No.	371163	Ref. No. —
membrane connection 1/2" series L140-B membrane type NBR (water)			
<b>accessories for</b> 370320			
	GEV No.	371091	Ref. No. —
power socket plug type DIN 43650B cable lengthmm small			

electric components



Зип-Общепит

vsezip.ru

+7(812)987-08-81

L180-B series



1

<b>GEV No.</b>	370391	<b>Ref. No.</b>	120122 H120122
<b>description</b>	solenoid valve 2-ways 24VAC connection 3/4" L 79mm DN 18mm -10 up to +90°C coil type Z610A membranes NBR (water) p max 12bar p min 0.35bar		
<b>For models:</b>	AC101, AC151, AC181, AC201, AC241, AC91, EDT100, EDT140, EDT170, EDT200, EDT230, EDT85		
<b>accessories for</b>	370391		
	<b>GEV No.</b>	371091	<b>Ref. No.</b> —
power socket plug type DIN 43650B cable lengthmm small			





1

<b>GEV No.</b>	370329	<b>Ref. No.</b>	120131 H120131
<b>description</b>	solenoid valve 2-ways 24VAC inlet 1/2" outlet 1/2" connection 1/2" L 66mm DN 13.5mm slide-on receptacle compact -10 up to +90°C SIRAI type series L180-B coil type Z610A membranes NBR (water) p max 12bar p min 0.35bar		
<b>For models:</b>	AC101, AC151, AC181, AC201, AC241, AC91, EDT100, EDT140, EDT170, EDT200, EDT230, EDT85, HG2LR, HGLR, TR-E100, TR-E150, TR-E170, TR-E200, TR-E230, TR-E90		
<b>spare parts for</b>	370329		
	<b>GEV No.</b>	371070	<b>Ref. No.</b> —
solenoid coil 24VAC 10VA SIRAI coil type Z610A seat ø 10mm			
	<b>GEV No.</b>	371171	<b>Ref. No.</b> —
membrane series L180-B membrane type NBR (water)			
<b>accessories for</b>	370329		
	<b>GEV No.</b>	371091	<b>Ref. No.</b> —
power socket plug type DIN 43650B cable lengthmm small			



1

<b>GEV No.</b>	370047	<b>Ref. No.</b>	120174 H120174
<b>description</b>	solenoid valve brass 2-ways 230VAC inlet 1/2" outlet 1/2" connection 1/2" L 66mm DN 13.5mm slide-on receptacle compact -10 up to +90°C SIRAI type series L180-B coil type Z610A membranes NBR (water) p max 12bar p min 0.35bar 50/60Hz		
<b>For models:</b>	EDI13ALTABT, EDI13BT, EDI6BT, EDI8BT		
<b>spare parts for</b>	370047		
	<b>GEV No.</b>	371085	<b>Ref. No.</b> —
solenoid coil 230VAC 4VA SIRAI coil type ZB10A seat ø 10mm 50/60Hz			

<b>GEV No.</b>	371171	<b>Ref. No.</b>	—
membrane series L180-B membrane type NBR (water)			
<b>accessories for</b>	370047		
	<b>GEV No.</b>	371091	<b>Ref. No.</b> —
power socket plug type DIN 43650B cable lengthmm small			

solenoid valves steam (water)

2-way

L140-D series



1

<b>GEV No.</b>	370625	<b>Ref. No.</b>	37906
<b>description</b>	solenoid valve brass 2-ways 230VAC inlet 1/2" outlet 1/2" connection 1/2" L 41mm DN 10mm slide-on receptacle compact -10 up to 100°C SIRAI type series L140-D coil type Z610A membranes EPDM p max 10bar p min 0.35bar 50/60Hz		

Solenoid valve - accessories

filters



1

<b>GEV No.</b>	503139	<b>Ref. No.</b>	26981
<b>description</b>	solenoid valve filter ø 19.5mm H 16mm		
<b>For models:</b>	APS43, APS48, APS48B, APS53, APS60, APSE43, APSE48, APSE53, APSE60, BPN48, BPS43, BPS52, C35, C43, C43ALTA, C43D, C48, C48D, C48DDL, C48DL, C53, C53D, C6, C60, C60D, C6D, C81, C81E, C90, C90E, CA120, CA55, CA90, CAP7, CAP7E, CM43, CM48, CM52, CM60, CMD43, CMD48, CMD52, CMD60, CR43, CR43D, CR48, CR48D, DP35, DP35D, DP40...(Other models you can see in the webshop)		



1

<b>GEV No.</b>	512030	<b>Ref. No.</b>	37907
<b>description</b>	fastening angle for solenoid valve suitable for HOONVED		



pressure switches

for warewashing

ø 58mm with male faston 6.3mm

with connection horizontal



<b>GEV No.</b>	541011	<b>Ref. No.</b>	130609 130624 130928 H130609
<b>description</b>	pressure control pressure range 110/70mbar connection 6mm ø 58mm pressure connection horizontal warewashing		
<b>For models:</b>	AC151, AC181, AC201, AC241, EDT140, EDT170, EDT200, EDT230, HD130BT, HD40ALTABT, HD40BT, HD60BT, HD80BT, HG2LR, HGLR, HT100, HT150, HTP195, HTP205, HTP220		



<b>GEV No.</b>	541972	<b>Ref. No.</b>	130635 H130635
<b>description</b>	pressure control pressure range 190/40mbar connection male faston 6.3mm ø 58mm pressure connection horizontal warewashing pressure connection ø 5.5mm		
<b>For models:</b>	C90DE2, C90E2, C90EBT2, EDI4, HD130BT, HD40ALTABT, HD40BT, HD60BT, HD80BT, LO56		



<b>GEV No.</b>	541045	<b>Ref. No.</b>	31171
<b>description</b>	pressure control pressure range 28/12mbar connection 6mm ø 58mm pressure connection horizontal warewashing		
<b>For models:</b>	60BT, 60BT-3, 60EBT, APS43, APS48, APS48B, APS53, APS60, APSE43, APSE48, APSE53, APSE60, C3, C35, C35E, C4, C43, C43-2, C43ALTA, C43D, C43DE, C43E, C46DE, C46E, C48, C48-2, C48D, C48D-2, C48DDL, C48DL, C48E, C53, C53D, C53DE, C53E, C60, C60D, C60DE, C60E, C68DE, C68E, C68EBT, C6DE, C6E, C6EBT, C81E, C81EBT, CDN3, CDN4, CR43...(Other models you can see in the webshop)		



<b>GEV No.</b>	541039	<b>Ref. No.</b>	130621 H130621
<b>description</b>	pressure control pressure range 45/25mbar connection 6mm ø 58mm pressure connection horizontal warewashing		
<b>For models:</b>	C90DE, C90EBT		

Зип Общепит

vsezip.ru

+7(812)987-08-81



<b>GEV No.</b>	541024	<b>Ref. No.</b>	25432
<b>description</b>	pressure control pressure range 60/40mbar connection 6mm ø 58mm pressure connection horizontal warewashing pressure connection ø 6mm		
<b>For models:</b>	C98, CA55, CAP7, CAP7E, CM48, CM52, CM60, CMD48, CMD52, ED550, LO62, M60, NK48, NK60, NKD48, NKD52, RCA1100, RCA1200, RCA1200i, SO55, SO55-400V3-50Hz-MARINE, SO55-440V3-60Hz-MARINE, SO55E, T6-80, UNI43R, UNI43RD, UNI48R, UNI48RD, UNI53R, UNI53RD		



<b>GEV No.</b>	541631	<b>Ref. No.</b>	130632 H130632
<b>description</b>	pressure control pressure range 75/45mbar connection 6mm ø 55mm pressure connection ø 5.5mm		
<b>For models:</b>	CAP10, CAP10BT, CAP10DE, CAP12, CAP12DE, CAP12EBT, CAP7E, SO100, SO100-400V3-50Hz-MARINE, SO100-440V3-60Hz-MARINE, SO120		

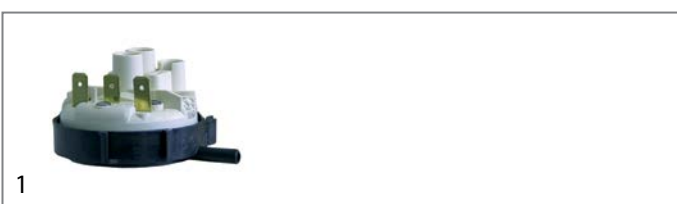

<b>GEV No.</b>	541017	<b>Ref. No.</b>	25433
<b>description</b>	pressure control with mounting strap pressure range 40/20mbar connection 6mm ø 58mm pressure connection horizontal warewashing		
<b>For models:</b>	60BT, BPN48, BPS43, BPS52, CM43, CMD43, E36, E40, E43, K80F, K80G, NK43, NKD43, SD5BT, T3-80, T4-80, T5-80		

ø 84mm with coded plug



<b>GEV No.</b>	541308	<b>Ref. No.</b>	130628 H130628
<b>description</b>	pressure control 3 pressure ranges pressure range 50/30 50/30 110/70mbar connection 6mm ø 84mm pressure connection horizontal warewashing suitable for COMENDA pressure connection ø 6mm		
<b>For models:</b>	60BT, 60BT-3, C81EBT, C90EBT, C90EBT2, CAP10BT, CAP12EBT, CAP15EBT, EDI13ALTABT, EDI13BT, EDI4, EDI6BT, EDI8BT, LO56, SD5BT		

1 electric components



Зип Общепит

vsezip.ru

+7(812)987-08-81

			
1			
<b>GEV No.</b>	541674	<b>Ref. No.</b>	130620 H130620
<b>description</b>	pressure control 3 pressure ranges pressure range 50/30 50/30 160/80mbar connection 6mm ø 84mm pressure connection horizontal warewashing suitable for COMENDA, HOONVED pressure connection ø 6mm		
<b>For models:</b>	AC101, AC151, AC181, AC201, AC241, AC91, EDI13ALTABT, EDI13BT, EDI6BT, EDI8BT, EDT100, EDT140, EDT170, EDT200, EDT230, EDT85, HG2LR, HGLR, HT100, HT150, HTP195, HTP205, HTP220, TR100, TR140, TR170, TR200, TR230, TR90, TR-E100, TR-E150, TR-E170, TR-E200, TR-E230, TR-E90		



			
1			
<b>GEV No.</b>	361385	<b>Ref. No.</b>	32311
<b>description</b>	level electrode 1/8" total length 55mm probe L 40x40mm insulated probe length 15mm curved 90° connection M4 ø 13mm		
<b>For models:</b>	AP43E, AP48E, AP53E, AP60E, APS43, APS48, APS48B, APS53, APS60, APSE43, APSE48, APSE53, APSE60, FW35, FW35E, FW40, FW40B, FW40E, FW45, FW50		

## miscellaneous

			
1			
<b>GEV No.</b>	541517	<b>Ref. No.</b>	37822
<b>description</b>	pressure control ø 37mm pressure connection ø 4mm		

			
1			
<b>GEV No.</b>	361386	<b>Ref. No.</b>	33431 35361
<b>description</b>	level electrode 1/8" total length 95mm probe L 82mm insulated probe length 15mm connection M4 ø 4mm		
<b>For models:</b>	C81, C90, C90E, CA120, CA90, ED650E, ED650S, LO50, LO50E, RLO50, SMW15, SMW15E, SP81, US-X501		

			
1			
<b>GEV No.</b>	541325	<b>Ref. No.</b>	30687
<b>description</b>	pressure control pressure range 4.5mbar		
<b>For models:</b>	60BT, APS43, APS48, APS48B, APS53, APS60, APSE43, APSE48, APSE53, APSE60, BPN48, BPS43, BPS52, CA120, ED600-95, ED630-90, ED650S, ED700-90, FW35, FW40, FW40B, FW45, FW50, LO60, LO78, SD5BT		

			
1			
<b>GEV No.</b>	400164	<b>Ref. No.</b>	27198
<b>description</b>	level electrode M10x1.5 probe L 2mm ø 4mm		
<b>For models:</b>	ED600-95, ED700-90, ED900-90, EDI5, LO122, LO60, LO61, LO78		
<b>accessories for</b>	400164		
		<b>GEV No.</b>	512376
		<b>Ref. No.</b>	25266
	flat gasket rubber ED ø 18mm ID ø 10mm thickness 2mm Qty 1 pcs		

## electrodes

			
1			
<b>GEV No.</b>	512072	<b>Ref. No.</b>	25042
<b>description</b>	level electrode 1/2" total length 78.5mm probe L 63mm insulated probe length 54mm connection M5x0.8 plastic ø 26mm		
<b>For models:</b>	ED600-95, ED630-90, ED650S, ED650S-90, ED700, ED700-90, ED900, ED900-90, EDI13, EDI13-2, EDI13ALTA, EDI13ALTA-2, EDI6, EDI6-2, EDI8, EDI8-2, LO122, LO134, LO134-2, LO134ALTA, LO134ALTA-2, LO60, LO67, LO67-2, LO78, LO83, LO83-2, RLO200, RLO300, RLO400		

## motors

## gear motors

## for dishwashers

			
1			
<b>GEV No.</b>	601665	<b>Ref. No.</b>	100246 H100246
<b>description</b>	gear motor NORD type SK 01-71L/6-4 0.10/0.15W 400V 50Hz 3 phase 12.2/18.8rpm shaft ø 19mm L 363mm speeds 2		
<b>For models:</b>	AC101, AC151, AC181, AC201, AC241, AC91, EDT100, EDT140, EDT170, EDT200, EDT230, EDT85, TR100, TR140, TR170, TR200, TR230, TR90, TR-E100, TR-E150, TR-E170, TR-E200, TR-E230		

pumps

wash and rinse pumps

FIR

pumps

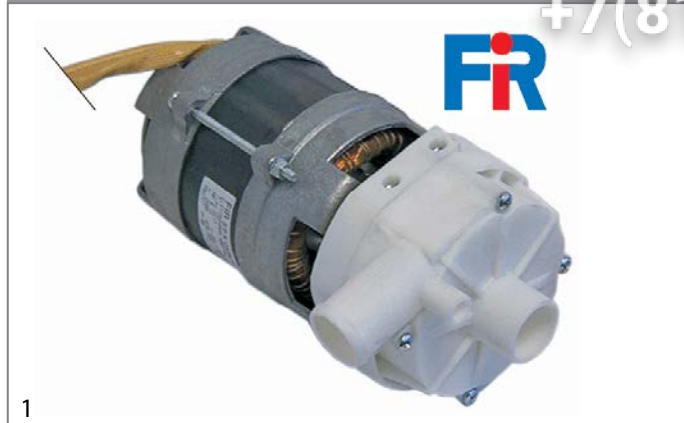

1

<b>GEV No.</b>	500037	<b>Ref. No.</b>	100747 H100747
<b>description</b>	pump inlet ø 28mm outlet ø 26mm type 2211.1410 230V 50Hz 1 phase 0.074kW 0.1HP L 190mm rotation direction left capacitor 5µF FIR		
<b>For models:</b>	60BT, SD5BT		
<b>spare parts for</b>	500037		
	<b>GEV No.</b>	365017	<b>Ref. No.</b> 32712 33543
	operating capacitor capacity 5µF 450V tolerance 5% 50/60Hz ambient temperature max. -25 to +85°C ø 28mm L 54mm M8 plastic connection male faston 6.3mm 16.10.08 protection		
	<b>GEV No.</b>	510384	<b>Ref. No.</b> —
	pump cover inlet ø 28mm outlet ø 26mm ø 100mm ID ø 76mm		
	<b>GEV No.</b>	510695	<b>Ref. No.</b> 34226
	mechanical shaft seal height counter ring 5.5mm ID ø 11mm		
	<b>GEV No.</b>	521203	<b>Ref. No.</b> —
	impellor ø 72mm H 18mm thread M7 shaft ø 11mm shaft length 32mm blades 3		
	<b>GEV No.</b>	521703	<b>Ref. No.</b> 34224
	pump cover gasket EPDM thickness 2.5mm ID ø 75mm Qty 1 pcs		

Зип Общепит

vsezip.ru

+7(812)987-08-81



1

<b>GEV No.</b>	500030	<b>Ref. No.</b>	N/A
<b>description</b>	pump inlet ø 28mm outlet ø 26mm type 4226.2540 230/400V 50Hz 3 phase 0.35kW 0.5HP L 260mm rotation direction right FIR		
<b>spare parts for</b>	500030		
	<b>GEV No.</b>	510510	<b>Ref. No.</b> 34225
	pump cover pump type 2212/2228/2229/2211		
	<b>GEV No.</b>	510690	<b>Ref. No.</b> —
	mechanical shaft seal for shaft ø 8mm ED ø 24mm mounting ø 24/26mm		
	<b>GEV No.</b>	521202	<b>Ref. No.</b> —
	impellor ø 72mm H 17mm thread M5L		
	<b>GEV No.</b>	521703	<b>Ref. No.</b> 34224
	pump cover gasket EPDM thickness 2.5mm ID ø 75mm Qty 1 pcs		



1

<b>GEV No.</b>	500019	<b>Ref. No.</b>	34194
<b>description</b>	pump inlet ø 28mm outlet ø 26mm type B229.1405 230V 50Hz 1 phase 0.22kW 0.3HP L 200mm rotation direction right capacitor 5µF FIR		
<b>For models:</b>	C35, C43, C43D, C48, C48D, CDN3, CDN4, CR43, CR43D, CR48, CR48D, SP35, SP35D, SP40, SP40D, SPB35, SPR36, SPR36D, SPR41, SPR41D		
<b>spare parts for</b>	500019		
	<b>GEV No.</b>	365017	<b>Ref. No.</b> 32712 33543
	operating capacitor capacity 5µF 450V tolerance 5% 50/60Hz ambient temperature max. -25 to +85°C ø 28mm L 54mm M8 plastic connection male faston 6.3mm 16.10.08 protection		
	<b>GEV No.</b>	510510	<b>Ref. No.</b> 34225
	pump cover pump type 2212/2228/2229/2211		



Table continues overleaf



Зип Общепит

vsezip.ru

+7(812)987-08-81

<b>spare parts for</b> 500019			
	GEV No.	510532	Ref. No. 34223
impellor ø 72mm H 22mm shaft ø 11mm shaft length 32mm blades 3			
	GEV No.	510695	Ref. No. 34226
mechanical shaft seal height counter ring 5.5mm ID ø 11mm			
	GEV No.	521703	Ref. No. 34224
pump cover gasket EPDM thickness 2.5mm ID ø 75mm Qty 1 pcs			



1

<b>GEV No.</b>	499170	<b>Ref. No.</b>	32027
<b>description</b>	pump inlet ø 45mm outlet ø 1" IT type 4243.1400 230V 1 phase 0.55kW 0.75HP L 310mm rotation direction right capacitor 12.5µF FIR		
<b>For models:</b>	APS43, APS48, APS48B, APS53, APS60, APSE48, APSE53, APSE60, BPN48, BPS52, FW35, FW40, FW40B, FW45, FW50		





1

<b>GEV No.</b>	500558	<b>Ref. No.</b>	33542 8455
<b>description</b>	pump inlet ø 33mm outlet ø 30/28mm type B266H1500 230V 50Hz 1 phase 0.22kW 0.3HP L 195mm rotation direction right capacitor 5µF FIR		
<b>For models:</b>	C43ALTA, C48DDL, C48DL, DP35, DP35D, DP40, DP40D, GS-X1011, GS-X1011-WEH, GS-X1021, GS-X1021-WEH, SP35ALTA, SP40DDL, SP40DL, STS43, STS43D, STS48, STS48D		

<b>spare parts for</b> 500558			
	GEV No.	365017	Ref. No. 32712 33543
operating capacitor capacity 5µF 450V tolerance 5% 50/60Hz ambient temperature max. -25 to +85°C ø 28mm L 54mm M8 plastic connection male faston 6.3mm 16.10.08 protection			

	GEV No.	510693	Ref. No. 26314 33840 34182 H630501 H630523
mechanical shaft seal for shaft ø 12mm slide ring ext. ø 24mm slide ring H 15.5mm slide ring int. ø 11mm counter ring mounting ø 24mm height counter ring 8mm counter ring int. ø 13.5mm			

	GEV No.	521545	Ref. No. 34341
pump cover FIR type B226H inlet ø 33mm outlet ø 30/28mm			

	GEV No.	521565	Ref. No. 34340
pump cover gasket pump type B226H			

	GEV No.	521566	Ref. No. 34339
impellor ø 80mm H 15mm M7L pump type B226H			



1

<b>GEV No.</b>	500463	<b>Ref. No.</b>	31260
<b>description</b>	pump inlet ø 45mm outlet ø 30mm type 2253 230V 50Hz 1 phase 0.24kW 0.33HP L 160mm rotation direction right FIR		
<b>For models:</b>	INDY48F, TS48, UNI48C, UNI48CD		

<b>spare parts for</b> 500463			
	GEV No.	521148	Ref. No. 31406
pump cover pump type Fir 2253(500.463)			



Зип Общепит

vsezip.ru

+7(812)987-08-81



1

<b>GEV No.</b>	500125	<b>Ref. No.</b>	31823
<b>description</b>	pump inlet $\varnothing$ 45mm outlet $\varnothing$ 30mm type 2253 230V 50Hz 1 phase 0.24kW 0.33HP L 175mm rotation direction right capacitor 10 $\mu$ F FIR inlet $\varnothing$ 45mm outlet $\varnothing$ 30mm		



1

<b>GEV No.</b>	500025	<b>Ref. No.</b>	25313 28850
<b>description</b>	pump inlet $\varnothing$ 45mm outlet $\varnothing$ 40mm type 3981.1400 230V 50Hz 1 phase 0.24kW 0.33HP rotation direction right FIR		
<b>For models:</b>	CM48, CMD48, NK48, NKD48, T3-80, T4-80, UNI48R, UNI48RD		







1

<b>GEV No.</b>	499123	<b>Ref. No.</b>	34170
<b>description</b>	pump inlet $\varnothing$ 45mm outlet $\varnothing$ 40mm type 4296.2350 230V 50Hz 1 phase 0.75kW L 250mm rotation direction right capacitor 16 $\mu$ F FIR		

**For models:** 60BT, 60BT-3, 60EBT, C53DE, C53E, C60, C60D, C60DE, C60E, DP45DE, DP45E, DP50, DP50D, DP50DE, DP50E, DP50EBT, RSP50, RSP50A, SD5BT, SP45DE, SP45E, SP50, SP50-400V, SP50-440V, SP50D, SP50DE, SP50E, ST53DE, ST53E, ST60DE, ST60E, ST60EBT, STS60, STS60D, TN-TDN5, TN-TDN6, VS-X313, VS-X313-LP-DOS, VS-X515, VS-X515-LP-DOS

**spare parts for** 499123

<b>GEV No.</b>	365021	<b>Ref. No.</b>	34173
	operating capacitor capacity 16 $\mu$ F 425V tolerance 5% 50/60Hz ambient temperature max. -25 to +85°C $\varnothing$ 35mm L 73mm single M8 plastic connection male faston 6.3mm 416.10.99 protection		
<b>GEV No.</b>	510608	<b>Ref. No.</b>	—
	impellor $\varnothing$ 93mm H 32mm shaft intake $\varnothing$ 9/8mm blades 6 inner height 11mm		
<b>GEV No.</b>	510692	<b>Ref. No.</b>	630510 H630510
	mechanical shaft seal for shaft $\varnothing$ 11mm slide ringext. $\varnothing$ 24mm slide ring H 13mm counter ring mounting $\varnothing$ 26mm height counter ring 8mm counter ring int. $\varnothing$ 14mm		
<b>GEV No.</b>	521539	<b>Ref. No.</b>	26181 26181 + 15211
	pump cover FIR inlet $\varnothing$ 45mm outlet $\varnothing$ 40mm auxiliary pressure connection 10mm supporting pressure open turn direction right $\varnothing$ 160mm ID $\varnothing$ 125mm inner height 25mm		
<b>GEV No.</b>	521702	<b>Ref. No.</b>	—
	pump cover gasket thickness 3.5x4.5mm Qty 1 pcs		

electric components

Зип-Общепит

vsezip.ru

+7(812)987-08-81



<b>GEV No.</b>	499285	<b>Ref. No.</b>	32244
<b>description</b>	pump inlet ø 45mm outlet ø 43mm type 4242.1400 230V 50Hz 1 phase 0.37kW 0.5HP L 270mm rotation direction right FIR		
<b>For models:</b>	APS43, APS48, APS48B, APS53, APS60, APSE43, BPS43, FW35, FW40, FW40B, FW45, FW50		

<b>spare parts for</b>	500018		
<b>GEV No.</b>	524416	<b>Ref. No.</b>	H630411
<b>description</b>	pump cover gasket thickness 4x4mm Qty 1 pcs		





<b>GEV No.</b>	499152	<b>Ref. No.</b>	25332
<b>description</b>	pump inlet ø 63mm outlet ø 53mm type 1205.2502 230/400V 50Hz 3 phase 2kW 2.7HP L 328mm rotation direction left auxiliary pressure connection 10mm FIR		
<b>For models:</b>	ED700		





<b>GEV No.</b>	500018	<b>Ref. No.</b>	H100361
<b>description</b>	pump inlet ø 63mm outlet ø 53mm type 1204.2528 230/400V 50Hz 3 phase 1.5kW 2HP L 328mm rotation direction left FIR		
<b>For models:</b>	EDT100, EDT140, EDT170, EDT200, EDT230, EDT85, TR100, TR140, TR170, TR200, TR230, TR90, TR-E200, TR-E230		

<b>spare parts for</b>	500018		
------------------------	--------	--	--

	<b>GEV No.</b>	510523	<b>Ref. No.</b>	—
		fan wheel ø 142mm shaft intake ø 15mm blades 12		

	<b>GEV No.</b>	510531	<b>Ref. No.</b>	630114 H630114
		pump cover FIR inlet ø 63mm outlet ø 53mm auxiliary pressure connection M16x1.5mm supporting pressure open turn direction left ø 185mm ID ø 150mm inner height 37mm		

	<b>GEV No.</b>	510604	<b>Ref. No.</b>	631618 H631618
		impellor ø 118mm H 34mm M8R rotation direction left		

	<b>GEV No.</b>	510693	<b>Ref. No.</b>	26314 33840 34182 H630501 H630523
		mechanical shaft seal for shaft ø 12mm slide ring ext. ø 24mm slide ring H 15.5mm slide ring int. ø 11mm counter ring mounting ø 24mm height counter ring 8mm counter ring int. ø 13.5mm		

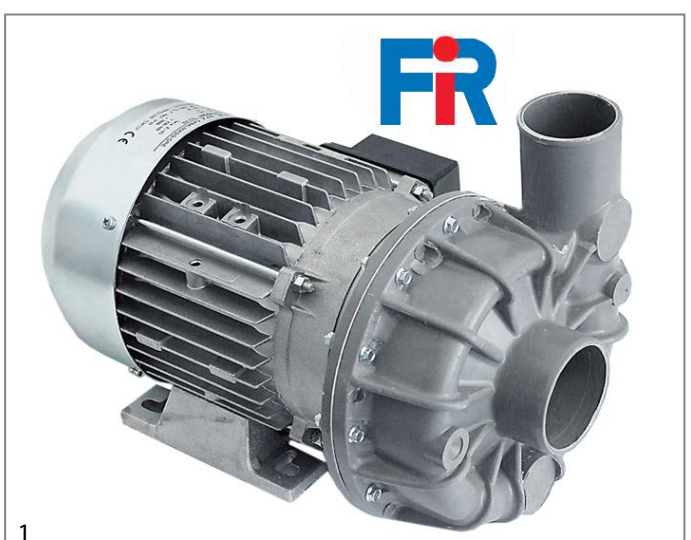

<b>GEV No.</b>	500111	<b>Ref. No.</b>	25326
<b>description</b>	pump inlet ø 63mm outlet ø 53mm type 1241.2500 230/400V 50Hz 3 phase 1.1kW 1.5HP L 330mm rotation direction left FIR		
<b>For models:</b>	CA120, CA90, CAP10, CAP10BT, CAP10DE, ED650E, ED650S, ED650S-90, RCA1200, RCA1200i, SO100, SO100-400V3-50Hz-MARINE		

<b>spare parts for</b>	500111		
------------------------	--------	--	--

	<b>GEV No.</b>	510531	<b>Ref. No.</b>	630114 H630114
		pump cover FIR inlet ø 63mm outlet ø 53mm auxiliary pressure connection M16x1.5mm supporting pressure open turn direction left ø 185mm ID ø 150mm inner height 37mm		

	<b>GEV No.</b>	510612	<b>Ref. No.</b>	26198
		impellor ø 110mm H 34mm M8R		

	<b>GEV No.</b>	510693	<b>Ref. No.</b>	26314 33840 34182 H630501 H630523
		mechanical shaft seal for shaft ø 12mm slide ring ext. ø 24mm slide ring H 15.5mm slide ring int. ø 11mm counter ring mounting ø 24mm height counter ring 8mm counter ring int. ø 13.5mm		

Table continues overleaf





Зип Общепит

vsezip.ru

+7(812)987-08-81

spare parts for 500111			
	GEV No.	524416	Ref. No. H630411
pump cover gasket thickness 4x4mm Qty 1 pcs			







1			
GEV No.	499300	Ref. No.	100886 H100886
description	pump inlet ø 63mm outlet ø 53mm type 5223.4050 230/400V 50Hz 3 phase 1.1kW L 316mm rotation direction left FIR		
For models:	TR-E90		



1			
GEV No.	499113	Ref. No.	34432
description	pump inlet ø 63mm outlet ø 53mm type 5234.4050 230/400V 50Hz 3 phase 1.62kW 2.2HP L 340mm rotation direction left FIR		



1			
GEV No.	499301	Ref. No.	35841
description	pump inlet ø 28mm outlet ø 26mm type ZF131DX 230V 50Hz 1 phase 0.2kW L 195mm rotation direction left capacitor 6.3µF LGB		
For models:	60BT, 60BT-3, 60EBT, C68EBT, C6EBT, C81EBT, C90EBT, C90EBT2, CAP10BT, CAP12EBT, DP50EBT, EDI4, LO56, SD5BT, ST48EBT, ST60EBT		
spare parts for 499301			
	GEV No.	365012	Ref. No. —
operating capacitor capacity 6.3µF 450V tolerance 5% 50Hz ambient temperature max. -25 to +85°C ø 30mm L 61mm M8 plastic connection male faston 6.3mm protection			
	GEV No.	510703	Ref. No. 38795
mechanical shaft seal for shaft ø 13mm slide ring H 13mm height counter ring 5.5mm ED ø 26mm			
	GEV No.	521084	Ref. No. —
pump cover LGB inlet ø 28mm outlet ø 25mm auxiliary pressure connection 13mm pump type ZF131DX ID ø 78mm			
	GEV No.	521228	Ref. No. —
impellor ø 72mm H 17mm rotation direction left thread M7R shaft ø 13mm shaft length 12mm blades 3			
	GEV No.	528800	Ref. No. 33183 34224
O-ring EPDM thickness 2.62mm ID ø 75.87mm Qty 1 pcs			

→ electric components





Зип Общепит

vsezip.ru

+7(812)987-08-81







1

<b>GEV No.</b>	500511	<b>Ref. No.</b>	35143
<b>description</b>	pump inlet ø 30mm outlet ø 29mm type ZF140SX 230V 50Hz 1 phase 0.36kW 0.5HP L 190mm rotation direction right LGB		
<b>For models:</b>	C35E, C43-2, C43DE, C43E, C46DE, C46E, C48-2, C48D-2, C48E, DP35-2, DP35D-2, DP40-2, DP40D-2, DP40D-rib2, DP40-rib2, GS-X1011-2, GS-X1011-WEH-2, GS-X1021-2, GS-X1021-2rib, GS-X1021-WEH-2, GS-X1021-WEH-2rib, RSP40, RSP40A, SP35-2, SP35DE, SP35E, SP40-2, SP40D-2, SP40DE, SP40E, SPB35E, ST43DE, ST43E, ST48DE, ST48E, ST48EBT, STS43-2, STS43D-2, STS48-2, STS48D-2, STS48D-rib2, STS48-rib2, TDN4-2rib		
<b>spare parts for</b>	500511		
	<b>GEV No.</b>	365017	<b>Ref. No.</b> 32712 33543
	operating capacitor capacity 5µF 450V tolerance 5% 50/60Hz ambient temperature max. -25 to +85°C ø 28mm L 54mm M8 plastic connection male faston 6.3mm 16.10.08 protection		
	<b>GEV No.</b>	510703	<b>Ref. No.</b> 38795
	mechanical shaft seal for shaft ø 13mm slide ring H 13mm height counter ring 5.5mm ED ø 26mm		
	<b>GEV No.</b>	521230	<b>Ref. No.</b> 35495
	impellor ø 86mm H 16mm M7L		
	<b>GEV No.</b>	521526	<b>Ref. No.</b> 35496
	pump cover LGB inlet ø 30mm outlet ø 30mm auxiliary pressure connection 12mm supporting pressure open turn direction right ø 117mm ID ø 95mm inner height 19mm		



1

<b>GEV No.</b>	500538	<b>Ref. No.</b>	25311 31654
<b>description</b>	pump inlet ø 30mm outlet ø 30mm type ZF150SX 230V 50Hz 1 phase 0.2kW 0.25HP L 170mm rotation direction right capacitor 10µF LGB		
<b>For models:</b>	CM43, CMD43, E36, E40, E40-2F, E43, INDY43F, NK43, NKD43, TS43, UNI43C, UNI43R, UNI43RD, UNI48R, UNI48RD		
<b>spare parts for</b>	500538		
	<b>GEV No.</b>	365015	<b>Ref. No.</b> —
	operating capacitor capacity 10µF 400V tolerance 5%Hz ambient temperature max. -25 to +85°C ø 35.5mm L 59mm M8 plastic connection male faston 6.3mm protection		
	<b>GEV No.</b>	510703	<b>Ref. No.</b> 38795
	mechanical shaft seal for shaft ø 13mm slide ring H 13mm height counter ring 5.5mm ED ø 26mm		
	<b>GEV No.</b>	521527	<b>Ref. No.</b> —
	pump cover LGB inlet ø 30mm outlet ø 30mm		
	<b>GEV No.</b>	521701	<b>Ref. No.</b> —
	pump cover gasket		
	<b>GEV No.</b>	521707	<b>Ref. No.</b> 26229
	pump cover gasket		



1

<b>GEV No.</b>	499084	<b>Ref. No.</b>	34170
<b>description</b>	pump inlet ø 44mm outlet ø 39mm type ZF340VSX 220-240V 50Hz 1 phase 0.7kW L 245mm rotation direction right capacitor 16µF LGB HOONVED		

Зип Общепит

vsezip.ru

+7(812)987-08-81



1			
<b>GEV No.</b>	500157	<b>Ref. No.</b>	31154
<b>description</b>	pump inlet ø 45mm outlet ø 39mm type ZF320SX 230V 50Hz 1 phase 0.75kW 1HP L 200mm rotation direction right capacitor 12µF LGB		
<b>spare parts for</b>	500157		
	<b>GEV No.</b>	510552	<b>Ref. No.</b> 26224 630410 H630410
	pump cover gasket pump type 1292-2/3942/3981/3911/3983		
	<b>GEV No.</b>	510702	<b>Ref. No.</b> 26194 31575 33181
	mechanical shaft seal height counter ring 5.5mm ID ø 12mm		
	<b>GEV No.</b>	521539	<b>Ref. No.</b> 26181 26181 + 15211
	pump cover FIR inlet ø 45mm outlet ø 40mm auxiliary pressure connection 10mm supporting pressure open turn direction right ø 160mm ID ø 125mm inner high 25mm		



1			
<b>GEV No.</b>	500120	<b>Ref. No.</b>	31898
<b>description</b>	pump inlet ø 45mm outlet ø 40mm type ZF320SX 230V 50Hz 1 phase 0.55kW 0.75HP L 200mm rotation direction right capacitor 12.5µF LGB		
<b>For models:</b>	INDY53F, UNI53C, UNI60C		
<b>spare parts for</b>	500120		
	<b>GEV No.</b>	365014	<b>Ref. No.</b> 25555
	operating capacitor capacity 12.5µF 450V tolerance 5%Hz ambient temperature max. -25 to +85°C ø 35mm L 70mm M8 plastic connection male faston 6.3mm 45S.C3DS.12.5 protection		
	<b>GEV No.</b>	510702	<b>Ref. No.</b> 26194 31575 33181
	mechanical shaft seal height counter ring 5.5mm ID ø 12mm		
	<b>GEV No.</b>	521300	<b>Ref. No.</b> 33843
	impellor ø 94mm H 27mm pump type ZF320SX thread M8L		
	<b>GEV No.</b>	521542	<b>Ref. No.</b> —
	pump cover LGB inlet ø 45mm outlet ø 40mm auxiliary pressure connection 13mm supporting pressure open ø 150mm ID ø 120mm inner high 25mm		

spare parts for 500120			
<b>GEV No.</b>	521714	<b>Ref. No.</b>	33853
	pump cover gasket thickness 4x4mm Qty 1 pcs		



1			
<b>GEV No.</b>	500919	<b>Ref. No.</b>	28851
<b>description</b>	pump inlet ø 45mm outlet ø 40mm type ZF320SX 230V 50Hz 1 phase 0.55kW 0.75HP L 200mm rotation direction right capacitor 12µF LGB		
<b>For models:</b>	CM52, CM60, CMD52, CMD60, E50, NK52, NK60, NKD52, NKD60, T5-80, UNI53R, UNI53RD		



1			
<b>GEV No.</b>	500121	<b>Ref. No.</b>	31682
<b>description</b>	pump inlet ø 45mm outlet ø 40mm type ZF320SX 230V 50Hz 1 phase 0.55kW 0.75HP L 220mm rotation direction right capacitor 12.5µF LGB		
<b>For models:</b>	C53, C53D, C53DE, C53E, C6, C60, C60DE, C60E, C6D, C6DE, C6E, C6EBT, DP45, DP45D, DP45DE, DP45E, DP50, DP50D, DP50DE, DP50E, DP50EBT, SP45, SP45D, SP45DE, SP45E, SP5, SP50DE, SP50E, SP5D, SP5DE, SP5E, ST53DE, ST53E, ST60DE, ST60E, ST60EBT, ST553, ST553D, ST560, ST560D, TN-TDN5, TN-TDN6		
<b>spare parts for</b>	500121		
	<b>GEV No.</b>	365014	<b>Ref. No.</b> 25555
	operating capacitor capacity 12.5µF 450V tolerance 5%Hz ambient temperature max. -25 to +85°C ø 35mm L 70mm M8 plastic connection male faston 6.3mm 45S.C3DS.12.5 protection		
	<b>GEV No.</b>	510702	<b>Ref. No.</b> 26194 31575 33181
	mechanical shaft seal height counter ring 5.5mm ID ø 12mm		
	<b>GEV No.</b>	521300	<b>Ref. No.</b> 33843
	impellor ø 94mm H 27mm pump type ZF320SX thread M8L		

Table continues overleaf









Зип Общепит

vsezip.ru





+7(812)987-08-81



<b>GEV No.</b>	500536	<b>Ref. No.</b>	31147
<b>description</b>	pump inlet ø 62mm outlet ø 52mm type AM5225DX 230V 50Hz 1 phase 0.9kW 1.2HP L 300mm rotation direction left capacitor 20µF LGB		
<b>For models:</b>	CA90, ED650E, ED650S		
<b>spare parts for</b>	500536		
	<b>GEV No.</b>	365019	<b>Ref. No.</b>
			—
	operating capacitor capacity 20µF 400V tolerance 5% 50/60Hz ambient temperature max. -25 to +85°C ø 39.5mm L 70mm M8 plastic connection male faston 6.3mm 16.10.25. protection		
	<b>GEV No.</b>	510551	<b>Ref. No.</b>
			26223 27066 33855
	pump cover gasket ID ø 158.3mm pump type 1214/1293/1225/2243/1226/1204/3473/1241 thickness 3.53mm EPDM Qty 1 pcs		
	<b>GEV No.</b>	510694	<b>Ref. No.</b>
			27067 33839
	mechanical shaft seal for shaft ø 13mm height counter ring 8mm ID ø 11.5mm H 16mm mounting ø 24/26mm int. ø 1 14mm		
	<b>GEV No.</b>	521217	<b>Ref. No.</b>
			33844
	impellor ø 110mm H 32mm thread M8R shaft ø 20mm shaft length 10mm seat ø 8.2mm blades 6 for ZF522DX		
	<b>GEV No.</b>	521516	<b>Ref. No.</b>
			33848 630154
	pump cover LGB inlet ø 62mm outlet ø 52mm auxiliary pressure connection 12mm supporting pressure closed turn direction left ø 190mm ID ø 150mm inner hight 40mm		

<b>spare parts for</b>	500121		
	<b>GEV No.</b>	521542	<b>Ref. No.</b>
			—
	pump cover LGB inlet ø 45mm outlet ø 40mm auxiliary pressure connection 13mm supporting pressure open ø 150mm ID ø 120mm inner hight 25mm		
	<b>GEV No.</b>	521714	<b>Ref. No.</b>
			33853
	pump cover gasket thickness 4x4mm Qty 1 pcs		



<b>GEV No.</b>	500122	<b>Ref. No.</b>	29562 34193
<b>description</b>	pump inlet ø 62mm outlet ø 52mm type AM5225DX 230/400V 50Hz 3 phase 1.2kW 1.6HP L 300mm rotation direction left LGB		
<b>For models:</b>	CA55, CA90, CAP7, ED550, ED650E, ED650E-90, K80F, K80G, RCA1100, SO55, SO55-400V3-50Hz-MARINE		
<b>spare parts for</b>	500122		
	<b>GEV No.</b>	501495	<b>Ref. No.</b>
			—
	cover plastic for terminal box for pump LGB		
	<b>GEV No.</b>	510551	<b>Ref. No.</b>
			26223 27066 33855
	pump cover gasket ID ø 158.3mm pump type 1214/1293/1225/2243/1226/1204/3473/1241 thickness 3.53mm EPDM Qty 1 pcs		
	<b>GEV No.</b>	510694	<b>Ref. No.</b>
			27067 33839
	mechanical shaft seal for shaft ø 13mm height counter ring 8mm ID ø 11.5mm H 16mm mounting ø 24/26mm int. ø 1 14mm		
	<b>GEV No.</b>	521236	<b>Ref. No.</b>
			33856
	impellor ø 105mm H 32mm M8R		
	<b>GEV No.</b>	521516	<b>Ref. No.</b>
			33848 630154
	pump cover LGB inlet ø 62mm outlet ø 52mm auxiliary pressure connection 12mm supporting pressure closed turn direction left ø 190mm ID ø 150mm inner hight 40mm		











Зип Общепит





vsezip.ru

+7(812)987-08-81



<b>GEV No.</b>	500537	<b>Ref. No.</b>	34800
<b>description</b>	pump inlet ø 62mm outlet ø 52mm type ZF522VDX 230V 50Hz 1 phase 0.85kW 1.16HP L 255mm rotation direction left capacitor 16µF auxiliary pressure connection 12mm supporting pressure open LGB		
<b>For models:</b>	CA55, CAP7, CAP7E, ED550, SO55, SO55E		
<b>spare parts for</b>	500537		
	<b>GEV No.</b>	365021	<b>Ref. No.</b> 34173
	operating capacitor capacity 16µF 425V tolerance 5% 50/60Hz ambient temperature max. -25 to +85°C ø 35mm L 73mm single M8 plastic connection male faston 6.3mm 416.10.99 protection		
	<b>GEV No.</b>	510551	<b>Ref. No.</b> 26223 27066 33855
	pump cover gasket ID ø 158.3mm pump type 1214/1293/1225/2243/1226/1204/3473/1241 thickness 3.53mm EPDM Qty 1 pcs		
	<b>GEV No.</b>	510693	<b>Ref. No.</b> 26314 33840 34182 H630501 H630523
	mechanical shaft seal for shaft ø 12mm slide ring ext. ø 24mm slide ring H 15.5mm slide ring int. ø 11mm counter ring mounting ø 24mm height counter ring 8mm counter ring int. ø 13.5mm		
	<b>GEV No.</b>	512420	<b>Ref. No.</b> —
	bracket mounting distance 110mm		
	<b>GEV No.</b>	512421	<b>Ref. No.</b> —
	fan wheel shaft intake ø 11mm ø 110mm H 20mm		
	<b>GEV No.</b>	521058	<b>Ref. No.</b> —
	fanwheel cover suitable for LGB ID ø 138mm ED ø 142mm H 59mm plastic		
	<b>GEV No.</b>	521281	<b>Ref. No.</b> —
	impellor ø 90mm H 30mm thread M8R shaft ø 20mm shaft length 10mm seat ø 8.2mm blades 6		
	<b>GEV No.</b>	521516	<b>Ref. No.</b> 33848 630154
	pump cover LGB inlet ø 62mm outlet ø 52mm auxiliary pressure connection 12mm supporting pressure closed turn direction left ø 190mm ID ø 150mm inner height 40mm		



<b>GEV No.</b>	499141	<b>Ref. No.</b>	34432 36334
<b>description</b>	pump inlet ø 62mm outlet ø 52mm type ZF800DX 230/400V 50Hz 3 phase 1.65kW 2.2HP L 336mm rotation direction left auxiliary pressure connection 12mm supporting pressure closed LGB		
<b>For models:</b>	C90, C90DE, C90DE2, C90E, C90E2, C90EBT, C90EBT2, C98, CAP10, CAP12, CAP12DE, CAP12EBT, EDI4, EDI6, EDI6-2, EDI6BT, HD40ALTABT, HD40BT, HD60BT, LO50, LO50E, LO56, LO62, LO67, LO67-2, RLO200, RLO50, SMW15, SMW15E, SO120, US-X501		
<b>spare parts for</b>	499141		
	<b>GEV No.</b>	510551	<b>Ref. No.</b> 26223 27066 33855
	pump cover gasket ID ø 158.3mm pump type 1214/1293/1225/2243/1226/1204/3473/1241 thickness 3.53mm EPDM Qty 1 pcs		
	<b>GEV No.</b>	510694	<b>Ref. No.</b> 27067 33839
	mechanical shaft seal for shaft ø 13mm height counter ring 8mm ID ø 11.5mm H 16mm mounting ø 24/26mm int. ø 14mm		
	<b>GEV No.</b>	521276	<b>Ref. No.</b> 34484
	impellor ø 120mm H 39mm pump type ZF800DX shaft intake ø 12mm rotation direction left thread M8R pump for ZF800DX blades 6		
	<b>GEV No.</b>	521516	<b>Ref. No.</b> 33848 630154
	pump cover LGB inlet ø 62mm outlet ø 52mm auxiliary pressure connection 12mm supporting pressure closed turn direction left ø 190mm ID ø 150mm inner height 40mm		

booster pumps I



<b>GEV No.</b>	499236	<b>Ref. No.</b>	100789 H100789
<b>description</b>	pump inlet ø 1 1/4" IT outlet ø 1" IT type CEA120/2/A 220-240/380-415V 50Hz 3 phase 0.64kW rotation direction left LOWARA		
<b>For models:</b>	EDI13-2, EDI13ALTA-2, EDI13ALTABT, EDI13BT, EDI6BT, EDI8-2, EDI8BT, HG2LR, HGLR, LO134-2, LO134ALTA-2, LO83-2		



Зип Общепит

vsezip.ru

+7(812)987-08-81



<b>GEV No.</b>	500060	<b>Ref. No.</b>	25342 25345
<b>description</b>	pump inlet $\varnothing$ 1" outlet $\varnothing$ 1" type PQM60 230V 50Hz 1 phase 0.37kW PEDRELLLO		
<b>For models:</b>	C90DE, C90DE2, C98, ED700, LO62		
<b>accessories for</b>	500060		
	<b>GEV No.</b>	365015	<b>Ref. No.</b> —
	operating capacitor capacity 10 $\mu$ F 400V tolerance 5%Hz ambient temperature max. -25 to +85°C $\varnothing$ 35.5mm L 59mm M8 plastic connection male faston 6.3mm protection		





<b>GEV No.</b>	500961	<b>Ref. No.</b>	H100342
<b>description</b>	drain pump inlet $\varnothing$ 30mm outlet $\varnothing$ 23mm 100W 230V 50Hz GRE		
<b>For models:</b>	CAP7, CAP7E, EDI4, LO56, SO55, SO55E		
<b>accessories for</b>	500961		
	<b>GEV No.</b>	524719	<b>Ref. No.</b> —
	formed hose hose ext. $\varnothing$ 40mm hose int. $\varnothing$ 30mm L 65mm warewashing black Qty 1		

### drain pumps

#### GRE



<b>GEV No.</b>	500967	<b>Ref. No.</b>	100803 H100803
<b>description</b>	drain pump inlet $\varnothing$ 30mm outlet $\varnothing$ 22mm 100W 230V 50Hz GRE		
<b>spare parts for</b>	500967		
	<b>GEV No.</b>	500307	<b>Ref. No.</b> —
	filter		
	<b>GEV No.</b>	500899	<b>Ref. No.</b> —
	pump cover inlet $\varnothing$ 30mm outlet $\varnothing$ 22mm pump type 500.213		



<b>GEV No.</b>	500462	<b>Ref. No.</b>	31623
<b>description</b>	drain pump inlet $\varnothing$ 30mm outlet $\varnothing$ 23mm 100W 230V 50Hz GRE		
<b>For models:</b>	APS43, APS48, APS48B, APS53, APS60, APSE43, APSE48, APSE53, APSE60, BPN48, BPS43, BPS52, FW35, FW40, FW40B, FW45, FW50, VS-X313, VS-X313-LP-DOS, VS-X515, VS-X515-LP-DOS		

#### HANNING



<b>GEV No.</b>	499286	<b>Ref. No.</b>	100893 35093
<b>description</b>	drain pump inlet $\varnothing$ 30mm outlet $\varnothing$ 24mm 220-240V 30W 50Hz HANNING type DPS25-131		
<b>For models:</b>	60BT, 60BT-3, 60EBT, AP43E, AP48E, AP53E, AP60E, APS43, APS48, APS48B, APS53, APS60, C35E, C43DE, C43E, C46DE, C46E, C53DE, C53E, C60DE, C60E, C68DE, C68E, C6DE, C6E, C6EBT, DP45DE, DP45E, DP50DE, DP50E, DP50EBT, FW35, FW35E, FW40, FW40B, FW40E, FW45, FW50, RSP50, RSP50A, SD5BT, SP35DE, SP35E, SP40DE, SP40E, SP45DE, SP45E, SP50DE, SP50E, SP50E-400V3-50Hz-MARINE...(Other models you can see in the webshop)		



booster pumps II

accessories



1			
<b>GEV No.</b>	365017	<b>Ref. No.</b>	32712 33543
<b>description</b>	operating capacitor capacity 5µF 450V tolerance 5% 50/60Hz ambient temperature max. -25 to +85°C ø 28mm L 54mm M8 plastic connection male faston 6.3mm 16.10.08 protection		
<b>For models:</b>	60BT, 60BT-3, 60EBT, AP43E, AP48E, C3, C35, C35E, C4, C43, C43-2, C43ALTA, C43D, C43DE, C43E, C46DE, C46E, C48, C48-2, C48D, C48D-2, C48DDL, C48DL, C48E, C90EBT, C90EBT2, C98, CAP10BT, CAP12EBT, CDN3, CDN4, CR43, CR43D, CR48, CR48D, DP35, DP35-2, DP35D, DP35D-2, DP40, DP40-2, DP40D, DP40D-2, DP40D-rib2, DP40-rib2, EDI13, EDI13-2, EDI13ALTA, EDI13ALTA-2, EDI4...(Other models you can see in the webshop)		

Зип Общепит

vseZEVU  
Image not available

+7(812)987-08-81

<b>GEV No.</b>	512067	<b>Ref. No.</b>	32544
<b>description</b>	operating capacitor capacity 40µF 450V		



1			
<b>GEV No.</b>	365017	<b>Ref. No.</b>	32712 33543
<b>description</b>	operating capacitor capacity 5µF 450V tolerance 5% 50/60Hz ambient temperature max. -25 to +85°C ø 28mm L 54mm M8 plastic connection male faston 6.3mm 16.10.08 protection		
<b>For models:</b>	60BT, 60BT-3, 60EBT, AP43E, AP48E, C3, C35, C35E, C4, C43, C43-2, C43ALTA, C43D, C43DE, C43E, C46DE, C46E, C48, C48-2, C48D, C48D-2, C48DDL, C48DL, C48E, C90EBT, C90EBT2, C98, CAP10BT, CAP12EBT, CDN3, CDN4, CR43, CR43D, CR48, CR48D, DP35, DP35-2, DP35D, DP35D-2, DP40, DP40-2, DP40D, DP40D-2, DP40D-rib2, DP40-rib2, EDI13, EDI13-2, EDI13ALTA, EDI13ALTA-2, EDI4...(Other models you can see in the webshop)		

condensators & interference suppression filters

operating capacitors

plastic



1			
<b>GEV No.</b>	365014	<b>Ref. No.</b>	25555
<b>description</b>	operating capacitor capacity 12.5µF 450V tolerance 5%Hz ambient temperature max. -25 to +85°C ø 35mm L 70mm M8 plastic connection male faston 6.3mm 45S.C3D5.12.5 protection		
<b>For models:</b>	AP53E, AP60E, APS43, APS48, APS48B, APS53, APS60, APSE43, APSE48, APSE53, APSE60, BPN48, BPS43, BPS52, C53, C53D, C53DE, C53E, C6, C60, C60DE, C60E, C68DE, C68E, C68EBT, C6D, C6DE, C6E, C6EBT, CM48, CM52, CM60, CMD48, CMD52, CMD60, DP45, DP45D, DP45DE, DP45E, DP50, DP50D, DP50DE, DP50E, E50, ED700-90, FW35, FW40, FW40B, FW45, FW50...(Other models you can see in the webshop)		

filters

interference suppression filters



1			
<b>GEV No.</b>	365046	<b>Ref. No.</b>	631209 H631209
<b>description</b>	interference suppression filter type 10S7E-G1474253105-Q 115/250V 50/60Hz conductor 2 with E connection male faston 6.3mm L 40mm ø 40mm Hmm Wmm M8 plastic Qty 1 pcs		
<b>For models:</b>	60EBT, C35E, C43DE, C43E, C46DE, C46E, C53DE, C53E, C60DE, C60E, C6DE, C6E, C6EBT, CAP10, CAP10BT, CAP10DE, CAP12, CAP12DE, CAP12EBT, CAP15EBT, EDI4, HD130BT, HD40ALTA, HD40BT, HD60BT, HD80BT		



1			
<b>GEV No.</b>	365021	<b>Ref. No.</b>	34173
<b>description</b>	operating capacitor capacity 16µF 425V tolerance 5% 50/60Hz ambient temperature max. -25 to +85°C ø 35mm L 73mm single M8 plastic connection male faston 6.3mm 416.10.99 protection		
<b>For models:</b>	60BT, 60BT-3, 60EBT, C53DE, C53E, C60, C60D, C60DE, C60E, C81, C81E, C81EBT, CA55, CAP7, CAP7E, DP50, DP50D, DP50DE, DP50E, DP50EBT, ED550, RSP50, RSP50A, SD5BT, SO55, SO55-400V3-50Hz-MARINE, SO55-440V3-60Hz-MARINE, SO55E, SP45DE, SP45E, SP50, SP50-400V, SP50-440V, SP50D, SP50DE, SP50E, SP81, SP81E, ST60DE, ST60E, ST60EBT, STS60, STS60D, TN-TDN5, TN-TDN6, VS-X313, VS-X313-LP-DOS, VS-X515, VS-X515-LP-DOS		



1			
<b>GEV No.</b>	365086	<b>Ref. No.</b>	31324
<b>description</b>	interference suppression filter type 10S7E-G1474253105-Q 115/250V 50/60Hz conductor 2 with E connection male faston 6.3mm L 40mm ø 40mm Hmm Wmm M8 plastic Qty 1 pcs		
<b>For models:</b>	60BT, 60BT-3, 60EBT, AP43E, AP48E, AP53E, AP60E, APS43, APS48, APS48B, APS53, APS60, APSE43, APSE48, APSE53, APSE60, C35, C35E, C43, C43-2, C43ALTA, C43D, C43DE, C43E, C46DE, C46E, C48, C48-2, C48D, C48D-2, C48DDL, C48DL, C48E, C53, C53D, C53DE, C53E, C6, C60, C60D, C60DE, C60E, C68DE, C68E, C68EBT, C6D, C6DE, C6E, C6EBT, C81...(Other models you can see in the webshop)		

fuses

fine fuses



<b>GEV No.</b>	358028	<b>Ref. No.</b>	130248 H130248
<b>description</b>	fine fuse size ø10x38mm 20A rated 500V type Gg fast-acting Qty 1 pcs		
<b>For models:</b>	AC101, AC151, AC181, AC201, AC241, AC91, EDT100, EDT140, EDT170, EDT200, EDT230, EDT85, HTP195, HTP205, HTP220, TR100, TR140, TR170, TR200, TR230, TR90, TR-E100, TR-E150, TR-E170, TR-E200, TR-E230		



<b>GEV No.</b>	358032	<b>Ref. No.</b>	28118
<b>description</b>	fine fuse size ø10x38mm 25A rated 500V type Gg fast-acting Qty 1 pcs		
<b>For models:</b>	ED600-95, ED700-90, EDI4, EDI5, EDI6, EDI6-2, EDI6BT, EDI8, EDI8-2, EDI8BT, LO56, LO60, LO61, LO67, LO67-2, LO78, LO83, LO83-2, RLO200, RLO300		



<b>GEV No.</b>	358021	<b>Ref. No.</b>	130260 H130260
<b>description</b>	fine fuse size ø10x38mm 2A rated 500V type gl fast-acting Qty 1 pcs		
<b>For models:</b>	AC101, AC151, AC181, AC201, AC241, AC91, EDT100, EDT140, EDT170, EDT200, EDT230, EDT85, TR100, TR140, TR170, TR200, TR230, TR90, TR-E100, TR-E150, TR-E170, TR-E200, TR-E230		



<b>GEV No.</b>	358023	<b>Ref. No.</b>	28048
<b>description</b>	fine fuse size ø10x38mm 6A rated 500V type Gg fast-acting Qty 1 pcs		
<b>For models:</b>	E40, E43, E50, ED600-95, ED630-90, ED700-90, EDI13, EDI13-2, EDI13ALTA, EDI13ALTA-2, EDI13ALTABT, EDI13BT, EDI4, EDI5, EDI6, EDI6-2, EDI6BT, EDI8, EDI8-2, EDI8BT, LO134, LO134-2, LO134ALTA, LO134ALTA-2, LO56, LO60, LO61, LO67, LO67-2, LO78, LO83, LO83-2, RLO200, RLO300, RLO400		

electric accessories

cables

ribbon cables

group 1



<b>GEV No.</b>	400066	<b>Ref. No.</b>	110501 37790
<b>description</b>	ribbon cable 10-pole L 1000mm plug type FC-10P raster size 2.54mm		
<b>For models:</b>	CAP7E, SO55E		

Зип Общепит

vsezip.ru

+7(812)987-08-81



<b>GEV No.</b>	402927	<b>Ref. No.</b>	110492 110498 36492
<b>description</b>	ribbon cable 10-pole L 500mm plug type FC-10P raster size 2.54mm		
<b>For models:</b>	50E, BT, C43DE, C43E, C44DE, C44E, C46E, C53DE, C53E, C60DE, C60E, C68DE, C68E, C68EBT, C6DE, C6E, C6EBT, DP45DE, DP45E, DP50DE, DP50E, DP50EBT, SP35DE, SP35E, SP40DE, SP40E, SP45DE, SP45E, SP50DE, SP50E, SP50E-400V3-50Hz-MARINE, SP50E-440V3-60Hz-MARINE, SP5DE, SP5E, SP68DE, SP68E, ST43DE, ST43E, ST48DE, ST48E, ST48EBT, ST53DE, ST53E, ST60DE, ST60E, ST60EBT		



<b>GEV No.</b>	402992	<b>Ref. No.</b>	H110482
<b>description</b>	ribbon cable 20-pole L 1250mm plug type 2 row coded		
<b>For models:</b>	AP43E, AP48E, AP53E, AP60E, C81E, C90DE, C90DE2, C90E, C90EBT, C90EBT2, CAP10, CAP10BT, CAP12, EDI13-2, EDI13ALTA-2, EDI13ALTABT, EDI13BT, EDI4, EDI6-2, EDI6BT, EDI8-2, EDI8BT, FW35E, FW40E, LO134-2, LO134ALTA-2, LO50E, LO56, LO67-2, LO83-2, SMW15E, SO100, SO100-400V3-50Hz-MARINE, SO100-440V3-60Hz-MARINE, SO120, SP81E		

terminals

connection terminals with screw/faston connections



<b>GEV No.</b>	550534 <sup>1</sup>	<b>Ref. No.</b>	H150226
<b>description</b>	power terminal block 3-pole max. 40A max 450V connection ø6mm <sup>2</sup> / F6.3 temp.-resist. 150°C cross section 6mm <sup>2</sup> mounting distance 67mm with ground lug		
<b>For models:</b>	C35E, C43DE, C43E, C46DE, C46E, C6DE, C6E, SP35DE, SP35E, SP40DE, SP40E, SP5DE, SP5E, SPB35E		

<sup>1</sup>with ground lug

equipment-specific units

for dough mixers

chains

connectors



<b>GEV No.</b>	693276	<b>Ref. No.</b>	H410903
<b>description</b>	connector single DIN/ISO 08 B-1 splitting 1/2" links 1 L 23mm internal width 11.8mm rollerø 4.3mm metal		
<b>For models:</b>	EDT100, EDT140, EDT170, EDT200, EDT230, EDT85, TR100, TR140, TR170, TR200, TR230, TR90, TR-E100, TR-E150, TR-E170, TR-E200, TR-E230		





for espresso machines

brewing units

filter holder gaskets

O-rings



1			
<b>GEV No.</b>	510409	<b>Ref. No.</b>	200815 33402 H200815
<b>description</b>	O-ring EPDM thickness 5.34mm ID ø 56.52mm Qty 1 pcs		
<b>For models:</b>	60BT, 60BT-3, 60EBT, AC101, AC151, AC181, AC201, AC241, AC91, AP53E, AP60E, APS43, APS48, APS53, APS60, C53, C53D, C53DE, C53E, C60, C60D, C60DE, C60E, C68DE, C68E, C68EBT, C6DE, C6E, C6EBT, C81, C81E, C81EBT, C90, C90DE, C90DE2, C90E, C90E2, C90EBT, C90EBT2, C98, CA120, CA55, CA90, CAP10, CAP10BT, CAP10DE, CAP12, CAP12DE, CAP12EBT...(Other models you can see in the webshop)		

for coffee grinders



1			
<b>GEV No.</b>	345019	<b>Ref. No.</b>	H120712
<b>description</b>	rotary switch sets of contacts 2 2 0-1 type CA0120002 380V 12A shaft ø 5x5mm shaft L 23mm shaft square connection screw		
<b>For models:</b>	EDT85, TR100, TR90, TR-E90		

for dishwashers

drain and intake components

HOONVED

drain /intake bodies



1			
<b>GEV No.</b>	510803	<b>Ref. No.</b>	160203 33524
<b>description</b>	connection angle ED ø 35mm ID ø 30mm		
<b>For models:</b>	AC101, AC151, AC181, AC201, AC241, AC91, C81, C81E, C81EBT, C90, C90DE, C90DE2, C90E, C90E2, C90EBT, C90EBT2, C98, CA120, CA55, CA90, CAP10, CAP10BT, CAP10DE, CAP12, CAP12DE, CAP12EBT, CAP15EBT, CAP7, CAP7E, ED550, ED600-95, ED650E, ED650S, ED700-90, EDI13, EDI13-2, EDI13ALTA, EDI13ALTA-2, EDI13ALTABT, EDI13BT, EDI4, EDI5, EDI6, EDI6-2, EDI6BT, EDI8, EDI8-2, EDI8BT, EDT100, EDT140...(Other models you can see in the webshop)		

Зип Общепит

vsezip.ru

+7(812)9877987



<b>GEV No.</b>	517638	<b>Ref. No.</b>	25107
<b>description</b>	connection angle thread 1" ø 27.5mm L 84mm		
<b>For models:</b>	CM43, CM43, CM52, CMD43, CMD48, CMD52, E36, E40, E43, E50, NK43, NK48, NK52, NKD43, NKD48, NKD52, T3-80, T4-80, UNI43R, UNI43RD, UNI48R, UNI48RD, UNI53R, UNI53RD		



1			
<b>GEV No.</b>	517636	<b>Ref. No.</b>	190234 31021
<b>description</b>	drain connection angled thread 1 1/4" ø 30mm L 82mm		
<b>For models:</b>	BPN48, BPS43, BPS52, C35E, C43DE, C43E, C46DE, C46E, SP35DE, SP35E, SP40DE, SP40E, SPB35E, ST43DE, ST43E, ST48DE, ST48E		



1			
<b>GEV No.</b>	512110	<b>Ref. No.</b>	190225 30421
<b>description</b>	drain connection thread 1 1/4" hose ø 30mm		
<b>For models:</b>	60BT, 60BT-3, 60EBT, C3, C35, C35E, C4, C43, C43-2, C43ALTA, C43D, C43DE, C43E, C46DE, C46E, C48, C48-2, C48D, C48D-2, C48DDL, C48DL, C48E, C53, C53D, C53DE, C53E, C6, C60, C60D, C60DE, C60E, C68DE, C68E, C68EBT, C6D, C6DE, C6E, C6EBT, CDN3, CDN4, CR43, CR43D, CR48, CR48D, DP35, DP35-2, DP35D, DP35D-2, DP40, DP40-2...(Other models you can see in the webshop)		

<b>accessories for</b>	512110		
	<b>GEV No.</b>	512111	<b>Ref. No.</b>
			28226



O-ring EPDM thickness 2.62mm ID ø 45.69mm Qty 1 pcs



1			
<b>GEV No.</b>	512348	<b>Ref. No.</b>	25003
<b>description</b>	drain fitting thread 1 1/4" ID ø 35mm		
<b>For models:</b>	CM60, CMD60, M60, NK60, NKD60, T5-80, T6-80		



1			
<b>GEV No.</b>	512345	<b>Ref. No.</b>	25002
<b>description</b>	drain fitting thread 1" ED ø 45mm H 50mm ID ø 25mm		
<b>For models:</b>	CM43, CM48, CM52, CMD43, CMD48, CMD52, E36, E40, E43, E50, NK43, NK48, NK52, NKD43, NKD48, NKD52, T3-80, T4-80, UNI43R, UNI43RD, UNI48R, UNI48RD, UNI53R, UNI53RD		



1

<b>GEV No.</b>	510805	<b>Ref. No.</b>	33525 H160301
<b>description</b>	drain fitting thread 1½" ED ø 68mm ID ø 39mm		
<b>For models:</b>	C81, C81E, C90, C90DE, C90E, C90EBT, C98, CA120, CA55, CA90, CAP7, CAP7E, ED550, ED600-95, ED650E, ED650S, ED700-90, EDI13, EDI13ALTA, EDI5, EDI6, EDI8, EDT100, EDT140, EDT170, EDT200, EDT230, EDT85, LO134, LO134ALTA, LO50, LO50E, LO60, LO61, LO62, LO67, LO78, LO83, RCA1100, RCA1200, RCA1200i, RLO200, RLO300, RLO400, RLO50, SMW15, SMW15E, SO55, SO55-400V3-50Hz-MARINE, SO55-440V3-60Hz-MARINE...(Other models you can see in the webshop)		
<b>accessories for</b>	510805		
	<b>GEV No.</b>	510498	<b>Ref. No.</b> 33527 H180109
	nut thread 1½"		



1

<b>GEV No.</b>	524582	<b>Ref. No.</b>	270409 H270409
<b>description</b>	drain fitting thread 1½" ID ø 35.5mm		
<b>For models:</b>	AC101, AC151, AC181, AC201, AC241, AC91, EDI13-2, EDI13ALTA-2, EDI13ALTABT, EDI13BT, EDI6-2, EDI6BT, EDI8-2, EDI8BT, EDT100, EDT140, EDT170, EDT200, EDT230, EDT85, HD130BT, HD60BT, HD80BT, LO134-2, LO134ALTA-2, LO67-2, LO83-2, TR100, TR140, TR170, TR200, TR230, TR90, TR-E100, TR-E150, TR-E170, TR-E200, TR-E230		
<b>accessories for</b>	524582		
	<b>GEV No.</b>	510876	<b>Ref. No.</b> 33530 H200412
	flat gasket rubber ED ø 45mm ID ø 33mm thickness 3mm Qty 1 pcs		
	<b>GEV No.</b>	511298	<b>Ref. No.</b> H160201
	hose connector hose ø 35mm		
	<b>GEV No.</b>	511309	<b>Ref. No.</b> H270104
	nut thread 1½" ø 66mm H 9mm WS 51 brass Qty 1 pcs		
	<b>GEV No.</b>	516254	<b>Ref. No.</b> 33529 H200410
	flat gasket rubber ED ø 66mm ID ø 46mm thickness 2.1mm Qty 1 pcs		



1

<b>GEV No.</b>	512125	<b>Ref. No.</b>	25138
<b>description</b>	drain fitting thread 1½" ID ø 39mm		
<b>For models:</b>	ED600-95, ED630-90, ED650E, ED650E-90, ED650S, ED650S-90, ED700, ED700-90, ED900, ED900-90, EDI5, K80F, K80G, LO122, LO60, LO61, LO78		

Зип Общепит  
vsezip.ru  
7(812)987-08-81

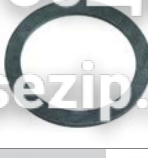

1

<b>GEV No.</b>	512150	<b>Ref. No.</b>	26637
<b>description</b>	flat gasket rubber D1 ø 55mm, D2 ø 42mm thickness 2mm Qty 1 pcs		
<b>For models:</b>	60BT, 60BT-3, 60EBT, C35, C43, C43D, C48, C48D, C53DE, C53E, C6, C60, C60D, C60DE, C60E, C68DE, C68E, C68EBT, C6D, C6DE, C6E, C6EBT, CM60, CMD60, CR43, CR43D, CR48, CR48D, DP45DE, DP45E, DP50, DP50D, DP50D-115V, DP50DE, DP50E, DP50EBT, NK60, NKD60, RSP50, RSP50A, SD5BT, SP35, SP35D, SP40, SP40D, SP45DE, SP45E, SP5, SP50, SP50-400V...(Other models you can see in the webshop)		



1

<b>GEV No.</b>	512346	<b>Ref. No.</b>	25261
<b>description</b>	flat gasket rubber ED ø 44mm ID ø 32mm thickness 2.5mm Qty 1 pcs		
<b>For models:</b>	CM43, CM48, CM52, CM60, CMD43, CMD48, CMD52, CMD60, E36, E40, E43, E50, ED600-95, ED630-90, ED650E, ED650E-90, ED650S, ED650S-90, ED700, ED700-90, ED900, ED900-90, EDI5, K80F, K80G, LO122, LO60, LO61, LO78, M60, NK43, NK48, NK52, NK60, NKD43, NKD48, NKD52, NKD60, T3-80, T4-80, T5-80, T6-80, UNI43R, UNI43RD, UNI48R, UNI48RD, UNI53R, UNI53RD		



1

<b>GEV No.</b>	510876	<b>Ref. No.</b>	33530 H200412
<b>description</b>	flat gasket rubber ED ø 45mm ID ø 33mm thickness 3mm Qty 1 pcs		
<b>For models:</b>	C81, C81E, C81EBT, C90, C90DE, C90DE2, C90E, C90E2, C90EBT, C90EBT2, C98, CA120, CA55, CA90, CAP10, CAP10BT, CAP10DE, CAP12, CAP12DE, CAP12EBT, CAP7, CAP7E, ED550, ED600-95, ED650E, ED650S, ED700-90, EDI13, EDI13-2, EDI13ALTA, EDI13ALTA-2, EDI13ALTABT, EDI13BT, EDI4, EDI5, EDI6, EDI6-2, EDI6BT, EDI8, EDI8-2, EDI8BT, EDT100, EDT140, EDT170, EDT200, EDT230, EDT85, HD130BT, HD40ALTABT, HD40BT...(Other models you can see in the webshop)		





1

<b>GEV No.</b>	512140	<b>Ref. No.</b>	31423
<b>description</b>	flat gasket rubber ED ø 65mm ID ø 51mm thickness 3mm Qty 1 pcs		
<b>For models:</b>	60BT, 60BT-3, APS60, C35, C43, C43ALTA, C43D, C48, C48D, C48DDL, C48DL, C53, C53D, C6, C60, C60D, C6D, CDN3, CDN4, CM48, CM52, CMD43, CMD52, CR43, CR43D, CR48, CR48D, DP35, DP35D, DP40, DP40D, DP45, DP45D, DP50, DP50D, DP50D-115V, FW50, GS-X1011, GS-X1011-WEH, GS-X1021, GS-X1021-WEH, RSP50, RSP50A, SD5BT, SP35, SP35ALTA, SP35D, SP40, SP40D, SP40DDL...(Other models you can see in the webshop)		





Зип Общепит  
vsezip.ru  
7(812)987-008-81



			
1			
<b>GEV No.</b>	516254	<b>Ref. No.</b>	33529 H200410
<b>description</b>	flat gasket rubber ED ø 66mm ID ø 46mm thickness 2mm Qty 1 pcs		
<b>For models:</b>	60BT-3, C81, C81E, C90, C90DE, C90E, C90EBT, C98, CA120, CA55, CA90, CAP7, CAP7E, ED550, ED600-95, ED650E, ED650S, ED700-90, EDI13, EDI13-2, EDI13ALTA, EDI13ALTA-2, EDI13ALTABT, EDI13BT, EDI5, EDI6, EDI6-2, EDI6BT, EDI8, EDI8-2, EDI8BT, EDT100, EDT140, EDT170, EDT200, EDT230, EDT85, LO134, LO134-2, LO134ALTA, LO134ALTA-2, LO50, LO50E, LO60, LO61, LO62, LO67, LO67-2, LO78, LO83...(Other models you can see in the webshop)		

			
1			
<b>GEV No.</b>	510875	<b>Ref. No.</b>	26289
<b>description</b>	flat gasket rubber ED ø 68mm ID ø 48mm thickness 2mm Qty 1 pcs		
<b>For models:</b>	ED600-95, ED630-90, ED650E, ED650E-90, ED650S, ED650S-90, ED700, ED700-90, ED900, ED900-90, EDI5, K80F, K80G, LO122, LO60, LO61, LO78		

			
1			
<b>GEV No.</b>	510832	<b>Ref. No.</b>	H200906
<b>description</b>	flat gasket rubber ED ø 92mm ID ø 66mm thickness 2mm Qty 1 pcs equiv. no. 200906/33456		
<b>For models:</b>	C81, C90, C90EBT, C98, CA120, CA55, CA90, CAP7, CAP7E, ED550, ED650E, ED650S, EDI13-2, EDI13ALTA-2, EDI6-2, EDI6BT, EDI8-2, EDT100, EDT140, EDT170, EDT200, EDT230, EDT85, LO134-2, LO134ALTA-2, LO50, LO62, LO67-2, LO83-2, RCA1100, RCA1200, RCA1200i, RLO50, SMW15, SO55, SO55E, SP81, TR100, TR140, TR170, TR200, TR230, TR90, TR-E100, TR-E150, TR-E170, TR-E200, TR-E230, TR-E90, US-X501		

			
1			
<b>GEV No.</b>	512148	<b>Ref. No.</b>	32717
<b>description</b>	gasket		
<b>For models:</b>	C60, C60D, DP50, DP50D, SP50, SP50-400V, SP50-440V, SP50D, STS60, STS60D, VS-X313, VS-X313-LP-DOS, VS-X515, VS-X515-LP-DOS		

			
1			
<b>GEV No.</b>	510807	<b>Ref. No.</b>	H160202
<b>description</b>	hose connector hose ø 30mm		
<b>For models:</b>	CAP10BT, EDI13, EDI13-2, EDI13ALTA, EDI13ALTA-2, EDI4, EDI6, EDI6-2, EDI8, EDI8-2, LO134, LO134-2, LO134ALTA, LO134ALTA-2, LO56, LO67, LO67-2, LO83, LO83-2, RLO200, RLO300, RLO400		

			
1			
<b>GEV No.</b>	511298	<b>Ref. No.</b>	H160201
<b>description</b>	hose connector hose ø 35mm		
<b>For models:</b>	EDT100, EDT140, EDT170, EDT200, EDT230, EDT85, TR100, TR140, TR170, TR200, TR230, TR90, TR-E100, TR-E150, TR-E170, TR-E200, TR-E230, TR-E90		
<b>accessories for</b>	511298		
	<b>GEV No.</b>	510356	<b>Ref. No.</b>
			180102 33526 H180102
	nut thread 1½"		
	<b>GEV No.</b>	510876	<b>Ref. No.</b>
			33530 H200412
	flat gasket rubber ED ø 45mm ID ø 33mm thickness 3mm Qty 1 pcs		

			
1			
<b>GEV No.</b>	512139	<b>Ref. No.</b>	25001
<b>description</b>	intake body		
<b>For models:</b>	C35, C43, C43D, C48, C48D, CDN3, CDN4, CM43, CM48, CM52, CM60, CMD43, CMD48, CMD52, CMD60, CR43, CR43D, CR48, CR48D, E36, E40, E43, E50, M60, NK43, NK48, NK52, NK60, NKD43, NKD48, NKD52, NKD60, SP35, SP35D, SP40, SP40D, SPB35, SPR36, SPR36D, SPR41, SPR41D, T3-80, T4-80, T5-80, T6-80, UNI43R, UNI43RD, UNI48R, UNI48RD, UNI53R...(Other models you can see in the webshop)		

			
1			
<b>GEV No.</b>	512149	<b>Ref. No.</b>	32716
<b>description</b>	intake body		
<b>For models:</b>	C60, C60D, DP50, DP50D, SP50, SP50-400V, SP50-440V, SP50D, STS60, STS60D, VS-X313, VS-X313-LP-DOS, VS-X515, VS-X515-LP-DOS		

			
1			
<b>GEV No.</b>	511329	<b>Ref. No.</b>	31621
<b>description</b>	intake body thread 1¼" ID ø 32mm		



1

<b>GEV No.</b>	512343	<b>Ref. No.</b>	31621
<b>description</b>	intake body thread 1 1/4" ID ø 32mm		
<b>For models:</b>	60EBT, AP43E, AP48E, AP53E, AP60E, APS43, APS48, APS48B, APS53, APS60, APSE43, APSE48, APSE53, APSE60, BPN48, BPS43, BPS52, C53DE, C53E, C60DE, C60E, C68DE, C68E, C6DE, C6E, C6EBT, DP45DE, DP45E, DP50DE, DP50E, DP50EBT, FW35, FW35E, FW40, FW40B, FW40E, FW45, FW50, SP45DE, SP45E, SP50DE, SP50E, SP50E-400V3-50Hz-MARINE, SP50E-440V3-60Hz-MARINE, SP5DE, SP5E, SP68DE, SP68E, ST43DE, ST43E...(Other models you can see in the webshop)		



2

<b>GEV No.</b>	512113	<b>Ref. No.</b>	160310 30425
<b>description</b>	intake body thread 1 1/2" ED ø 50mm		
<b>For models:</b>	60EBT, AP43E, AP48E, AP53E, AP60E, APS43, APS48, APS48B, APS53, APSE43, APSE48, APSE53, BPN48, BPS43, BPS52, C35E, C43-2, C43DE, C43E, C46DE, C46E, C48-2, C48D-2, C48E, C53DE, C53E, C60DE, C60E, C68DE, C68E, C68EBT, C6DE, C6E, C6EBT, DP35-2, DP35D-2, DP40-2, DP40D-2, DP40D-rib2, DP40-rib2, DP45DE, DP45E, DP50DE, DP50E, DP50EBT, E40-2F, FW35, FW35E, FW40, FW40B...(Other models you can see in the webshop)		
<b>accessories for</b>	512113		
	<b>GEV No.</b>	528192	<b>Ref. No.</b> 200842 31948
O-ring EPDM thickness 3mm ID ø 56mm Qty 1 pcs			



1

<b>GEV No.</b>	512153	<b>Ref. No.</b>	32715
<b>description</b>	intake body thread 1 1/2" hose ø 40mm		
<b>For models:</b>	60BT, 60BT-3, AP560, APSE60, C3, C4, C43ALTA, C48DDL, C48DL, C53, C53D, C6, C60, C60D, C6D, DP35, DP35D, DP40, DP40D, DP45, DP45D, DP50, DP50D, DP50D-115V, FW50, GS-X1011, GS-X1011-WEH, GS-X1021, GS-X1021-WEH, RSP50, RSP50A, SD5BT, SP35ALTA, SP40DDL, SP40DL, SP45, SP45D, SP5, SP50, SP50-400V, SP50-440V, SP50D, SP5D, STS43, STS43D, STS48, STS48D, STS53, STS53D, STS60...(Other models you can see in the webshop)		



1

<b>GEV No.</b>	510472	<b>Ref. No.</b>	180235 33451
<b>description</b>	intake body thread 2" ID ø 50mm		
<b>For models:</b>	C81, C81E, C81EBT, C90, C90DE, C90E, C90EBT, C98, CA120, CA55, CA90, CAP7, CAP7E, ED550, ED650E, ED650S, HG2LR, HGLR, LO50, LO50E, LO62, RCA1100, RCA1200, RCA1200i, RLO50, SMW15, SMW15E, SO55, SO55-400V3-50Hz-MARINE, SO55-440V3-60Hz-MARINE, SO55E, SP81, SP81E, US-X501		

Зип Общепит

vsezip.ru

7(812)987-08-81



1

<b>GEV No.</b>	510815	<b>Ref. No.</b>	H180236
<b>description</b>	intake body thread 2" ID ø 51mm		
<b>For models:</b>	EDI13-2, EDI13ALTA-2, EDI6-2, EDI6BT, EDI8-2, EDT100, EDT140, EDT170, EDT200, EDT230, EDT85, LO134-2, LO134ALTA-2, LO67-2, LO83-2, TR100, TR140, TR170, TR200, TR230, TR90, TR-E100, TR-E150, TR-E170, TR-E200, TR-E230, TR-E90		



1

<b>GEV No.</b>	519583	<b>Ref. No.</b>	h180248
<b>description</b>	intake/drain body thread 1 1/2" ED ø 130mm ID ø 90mm hose ø 50mm		



1

<b>GEV No.</b>	512127	<b>Ref. No.</b>	25007
<b>description</b>	nut for drain assembly thread 1 1/2" ED ø 69mm		
<b>For models:</b>	CM43, CM48, CM52, CM60, CMD43, CMD48, CMD52, CMD60, E36, E40, E43, E50, ED600-95, ED630-90, ED650E, ED650E-90, ED650S, ED650S-90, ED700, ED700-90, ED900, ED900-90, EDI5, K80F, K80G, LO122, LO60, LO61, LO78, NK43, NK48, NK52, NK60, NKD43, NKD48, NKD52, NKD60, UNI43R, UNI43RD, UNI48R, UNI48RD, UNI53R, UNI53RD		



1

<b>GEV No.</b>	512347	<b>Ref. No.</b>	25005
<b>description</b>	nut thread 1"		
<b>For models:</b>	CM43, CM48, CM52, CMD43, CMD48, CMD52, E36, E40, E43, E50, NK43, NK48, NK52, NKD43, NKD48, NKD52, T3-80, T4-80, UNI43R, UNI43RD, UNI48R, UNI48RD, UNI53R, UNI53RD		





Зип-Общепит

vsezip.ru

(812)987-08-81

 <p>1</p>			
<b>GEV No.</b>	510356	<b>Ref. No.</b>	180102 33523 H180102
<b>description</b>	nut thread 1 1/2"		
<b>For models:</b>	AC101, AC151, AC181, AC201, AC241, AC91, C81, C81E, C81EBT, C90, C90DE, C90DE2, C90E, C90E2, C90EBT, C90EBT2, C98, CA120, CA55, CA90, CAP10, CAP10BT, CAP10DE, CAP12, CAP12DE, CAP12EBT, CAP15EBT, CAP7, CAP7E, ED550, ED600-95, ED650E, ED650S, ED700-90, EDI13, EDI13-2, EDI13ALTA, EDI13ALTA-2, EDI13ALTABT, EDI13BT, EDI4, EDI5, EDI6, EDI6-2, EDI6BT, EDI8, EDI8-2, EDI8BT, EDT100, EDT140... (Other models you can see in the webshop)		
<b>accessories for</b>	510356		
 <p>GEV No. 510876 Ref. No. 33530 H200412</p> <p>flat gasket rubber ED ø 45mm ID ø 33mm thickness 3mm Qty 1 pcs</p>			
 <p>GEV No. 511298 Ref. No. H160201</p> <p>hose connector hose ø 35mm</p>			

 <p>1</p>			
<b>GEV No.</b>	511332	<b>Ref. No.</b>	180145
<b>description</b>	nut thread 1 3/4"		
 <p>1</p>			
<b>GEV No.</b>	512146	<b>Ref. No.</b>	25009
<b>description</b>	nut thread 2" ED ø 60mm		
<b>For models:</b>	C60, C60D, CM60, CMD60, DP50, DP50D, NK60, NKD60, SP50, SP50-400V, SP50-440V, SP50D, STS60, STS60D, T5-80, T6-80, VS-X313, VS-X313-LP-DOS, VS-X515, VS-X515-LP-DOS		

 <p>1</p>			
<b>GEV No.</b>	510498	<b>Ref. No.</b>	33527 H180109
<b>description</b>	nut thread 1 1/2"		
<b>For models:</b>	C81, C81E, C90, C90DE, C90E, C90EBT, C98, CA120, CA55, CA90, CAP7, CAP7E, ED550, ED600-95, ED650E, ED650S, ED700-90, EDI13, EDI13ALTA, EDI5, EDI6, EDI8, EDT100, EDT140, EDT170, EDT200, EDT230, EDT85, LO134, LO134ALTA, LO50, LO50E, LO60, LO61, LO62, LO67, LO78, LO83, RCA1100, RCA1200, RCA1200i, RLO200, RLO300, RLO400, RLO50, SMW15, SMW15E, SO55, SO55-400V3-50Hz-MARINE, SO55-440V3-60Hz-MARINE... (Other models you can see in the webshop)		

 <p>1</p>			
<b>GEV No.</b>	510469	<b>Ref. No.</b>	191057 33452
<b>description</b>	opposite support ED ø 130mm H 74mm		
<b>For models:</b>	C81, C81E, C81EBT, C90, C90DE, C90E, C90EBT, C98, CA120, CA55, CA90, CAP7, CAP7E, ED550, ED650E, ED650S, LO50, LO50E, LO62, RCA1100, RCA1200, RCA1200i, RLO50, SMW15, SMW15E, SO55, SO55-400V3-50Hz-MARINE, SO55-440V3-60Hz-MARINE, SO55E, SP81, SP81E, US-X501		

 <p>1</p>			
<b>GEV No.</b>	512115	<b>Ref. No.</b>	25006
<b>description</b>	nut thread 1 1/2" H 10mm		
<b>For models:</b>	60BT, 60BT-3, 60EBT, AP43E, AP48E, AP53E, AP60E, APS43, APS48, APS48B, APS53, APS60, APSE43, APSE48, APSE53, APSE60, BPN48, BPS43, BPS52, C3, C35, C35E, C4, C43, C43-2, C43ALTA, C43D, C43DE, C43E, C46DE, C46E, C48, C48-2, C48D, C48D-2, C48DDL, C48DL, C48E, C53, C53D, C53DE, C53E, C6, C60, C60D, C60DE, C60E, C68DE, C68E, C68EBT... (Other models you can see in the webshop)		

 <p>1</p>			
<b>GEV No.</b>	512111	<b>Ref. No.</b>	28226
<b>description</b>	O-ring EPDM thickness 2.62mm ID ø 45.69mm Qty 1 pcs		
<b>For models:</b>	60BT, 60BT-3, 60EBT, AP43E, AP48E, AP53E, AP60E, APS43, APS48, APS48B, APS53, APS60, APSE43, APSE48, APSE53, APSE60, BPN48, BPS43, BPS52, C3, C35, C35E, C4, C43, C43-2, C43ALTA, C43D, C43DE, C43E, C46DE, C46E, C48, C48-2, C48D, C48D-2, C48DDL, C48DL, C48E, C53, C53D, C53DE, C53E, C6, C60, C60D, C60DE, C60E, C68DE, C68E, C68EBT... (Other models you can see in the webshop)		

 <p>1</p>			
<b>GEV No.</b>	511309	<b>Ref. No.</b>	H270104
<b>description</b>	nut thread 1 1/2" ø 66mm H 9mm WS 51 brass Qty 1 pcs		
<b>For models:</b>	EDI13-2, EDI13ALTA-2, EDI13ALTABT, EDI13BT, EDI6-2, EDI6BT, EDI8-2, EDI8BT, EDT100, EDT140, EDT170, EDT200, EDT230, EDT85, LO134-2, LO134ALTA-2, LO67-2, LO83-2, TR100, TR140, TR170, TR200, TR230, TR90, TR-E100, TR-E150, TR-E170, TR-E200, TR-E230, TR-E90		

 <p>1</p>			
<b>GEV No.</b>	528192	<b>Ref. No.</b>	200842 31948
<b>description</b>	O-ring EPDM thickness 3mm ID ø 56mm Qty 1 pcs		
<b>For models:</b>	60EBT, AP43E, AP48E, AP53E, AP60E, APS43, APS48, APS48B, APS53, APS60, APSE43, APSE48, APSE53, APSE60, BPN48, BPS43, BPS52, C35E, C43-2, C43DE, C43E, C46DE, C46E, C48-2, C48D-2, C48E, C53DE, C53E, C60DE, C60E, C68DE, C68E, C68EBT, C6DE, C6E, C6EBT, DP35-2, DP35D-2, DP40-2, DP40D-2, DP40D-rib2, DP40-rib2, DP45DE, DP45E, DP50DE, DP50E, DP50EBT, FW35, FW35E, FW40... (Other models you can see in the webshop)		



1

<b>GEV No.</b>	691940	<b>Ref. No.</b>	25293
<b>description</b>	plug		
<b>For models:</b>	AP43E, AP48E, APS43, APS48, APS48B, APS53, APS60, APSE43, APSE48, APSE53, APSE60, C3, C35, C4, C43, C43ALTA, C43D, C48, C48D, C48DDL, C48DL, C53, C53D, C60, C60D, C81, C90, CR43, CR43D, CR48, CR48D, DP35, DP35D, DP40, DP40D, DP45, DP45D, DP50, DP50D, E50, FW35, FW35E, FW40, FW40B, FW40E, FW45, FW50, GS-X1011, GS-X1011-WEH, GS-X1021...(Other models you can see in the webshop)		



1

<b>GEV No.</b>	512344	<b>Ref. No.</b>	34790
<b>description</b>	ring thread 1 1/4" ED ø 71mm ID ø 33mm		
<b>For models:</b>	60BT, 60BT-3, C6, C60, C60D, C6D, DP50, DP50D, DP50D-115V, RSP50, RSP50A, SD5BT, SP5, SP50, SP50-400V, SP50-440V, SP50D, SP5D, STS60, STS60D, TN-TDN5, TN-TDN6, VS-X313, VS-X313-LP-DOS, VS-X515, VS-X515-LP-DOS		



1

<b>GEV No.</b>	512143	<b>Ref. No.</b>	33734
<b>description</b>	ring thread 1 1/4" ID ø 33mm		
<b>For models:</b>	C35, C43, C43D, C48, C48D, CDN3, CDN4, CR43, CR43D, CR48, CR48D, SP35, SP35D, SP40, SP40D, SPB35, SPR36, SPR36D, SPR41, SPR41D		



1

<b>GEV No.</b>	512109	<b>Ref. No.</b>	180147 30422 31637
<b>description</b>	screw connection thread 1 1/4"		
<b>For models:</b>	60EBT, AP43E, AP48E, AP53E, AP60E, APS43, APS48, APS48B, APS53, APS60, APSE43, APSE48, APSE53, APSE60, BPN48, BPS43, BPS52, C3, C35E, C4, C43-2, C43ALTA, C43DE, C43E, C46DE, C46E, C48-2, C48D-2, C48DDL, C48DL, C48E, C53, C53D, C53DE, C53E, C60DE, C60E, C68DE, C68E, C68EBT, C6DE, C6E, C6EBT, DP35, DP35-2, DP35D, DP35D-2, DP40, DP40-2, DP40D...(Other models you can see in the webshop)		



1

<b>GEV No.</b>	510499	<b>Ref. No.</b>	33450 H180128
<b>description</b>	union nut thread 2"		
<b>For models:</b>	C81, C81E, C90, C90DE, C90E, C90EBT, C98, CA120, CA55, CA90, CAP7, CAP7E, ED550, ED650E, ED650S, EDI13-2, EDI13ALTA-2, EDI6-2, EDI6BT, EDI8-2, EDT100, EDT140, EDT170, EDT200, EDT230, EDT85, LO134-2, LO134ALTA-2, LO50, LO50E, LO62, LO67-2, LO83-2, RCA1100, RCA1200, RCA1200i, RLO50, SMW15, SMW15E, SO55, SO55-400V3-50Hz-MARINE, SO55-440V3-60Hz-MARINE, SO55E, SP81, SP81E, TR100, TR140, TR170, TR200, TR230...(Other models you can see in the webshop)		

Зип-Общепит

vsezip.ru

+7(812)987 08 01



1

<b>GEV No.</b>	517630	<b>Ref. No.</b>	36166
<b>description</b>	filter for dishwasher H 115mm L 515mm W 263mm SS with hole mounting pos. front		
<b>For models:</b>	EDI13-2, EDI13ALTA-2, EDI13ALTABT, EDI13BT, HD130BT, LO134-2, LO134ALTA-2		



1

<b>GEV No.</b>	517631	<b>Ref. No.</b>	36090
<b>description</b>	filter for dishwasher H 115mm L 515mm W 263mm SS without hole mounting pos. rear		
<b>For models:</b>	EDI13-2, EDI13ALTA-2, EDI13ALTABT, EDI13BT, HD130BT, LO134-2, LO134ALTA-2		



1

<b>GEV No.</b>	519557	<b>Ref. No.</b>	34876
<b>description</b>	filter for dishwasher H 75mm L 525mm W 200mm SS		
<b>For models:</b>	EDI13, EDI13ALTA, EDI6, EDI8, LO134, LO134ALTA, LO67, LO83, RLO400		



1

<b>GEV No.</b>	512353	<b>Ref. No.</b>	25018
<b>description</b>	filter support ø 63mm thread M6		
<b>For models:</b>	CM48, CMD48, NK48, NKD48, UNI48R, UNI48RD		





1

<b>GEV No.</b>	512138	<b>Ref. No.</b>	25019
<b>description</b>	filter support ø 64mm thread M6		
<b>For models:</b>	C35, C43, C43D, C48, C48D, CDN3, CDN4, CM43, CM52, CM60, CMD43, CMD52, CMD60, CR43, CR43D, CR48, CR48D, E36, E40, E43, E50, NK43, NK52, NK60, NKD43, NKD52, NKD60, SP35, SP35D, SP40, SP40D, SPB35, SPR36, SPR36D, SPR41, SPR41D, UNI43R, UNI43RD, UNI53R, UNI53RD		





Зип Общепит  
vsezip.ru  
+7(812)987-08-81

			
1			
<b>GEV No.</b>	512105	<b>Ref. No.</b>	21451
<b>description</b>	flat filter		
<b>For models:</b>	E40-2F, INDY43F, INDY48F, TS43, TS48, UNI43C, UNI48C, UNI48CD, UNI53C, UNI60C		

			
1			
<b>GEV No.</b>	512145	<b>Ref. No.</b>	22012/R
<b>description</b>	flat filter		
<b>For models:</b>	AP560, C60, C60D, DP50, DP50D, FW50, SP50, SP50-400V, SP50-440V, SP50D, STS60, STS60D, VS-X313, VS-X313-LP-DOS, VS-X515, VS-X515-LP-DOS		

			
1			
<b>GEV No.</b>	510370	<b>Ref. No.</b>	34420
<b>description</b>	flat filter H 15mm L 265mm W 200mm		
<b>For models:</b>	C90, C90DE, C90E, C90EBT, C98, CA120, ED650S, LO50, LO50E, LO62, RCA1200, RCA1200i, RLO50, SMW15, SMW15E, US-X501		

			
1			
<b>GEV No.</b>	510656	<b>Ref. No.</b>	H332003
<b>description</b>	flat filter H 38mm L 428mm W 278mm		
<b>For models:</b>	EDT100, EDT140, EDT170, EDT200, EDT230, EDT85		

			
1			
<b>GEV No.</b>	512155	<b>Ref. No.</b>	180848 30420
<b>description</b>	flat filter L 205mm W 205mm		
<b>For models:</b>	BPS43, C3, C35E, C4, C53, C53D, DP35, DP35D, DP40, DP40D, DP45, DP45D, E40-2F, INDY43F, INDY48F, SP45, SP45D, STS43, STS43D, STS48, STS48D, STS53, STS53D, TS48, UNI43C, UNI48C, UNI48CD, UNI53C, UNI60C		

			
1			
<b>GEV No.</b>	512333	<b>Ref. No.</b>	21574
<b>description</b>	flat filter L 205mm W 205mm		
<b>For models:</b>	APS43, APS48, APS48B, APS53, APSE43, APSE48, APSE53, BPN48, BPS43, BPS52, FW35, FW40, FW40B, FW45		

			
1			
<b>GEV No.</b>	512336	<b>Ref. No.</b>	34658
<b>description</b>	flat filter L 210mm W 210mm		
<b>For models:</b>	C43-2, C43ALTA, C43DE, C43E, C46DE, C46E, C48-2, C48D-2, C48DDL, C48DL, C48E, C53, C53D, DP35, DP35-2, DP35D, DP35D-2, DP40, DP40-2, DP40D, DP40D-2, DP40D-rib2, DP40-rib2, DP45, DP45D, GS-X1011, GS-X1011-2, GS-X1011-WEH, GS-X1011-WEH-2, GS-X1021, GS-X1021-2, GS-X1021-2rib, GS-X1021-WEH, GS-X1021-WEH-2, GS-X1021-WEH-2rib, RSP40, RSP40A, SP35-2, SP35ALTA, SP35DE, SP35E, SP40-2, SP40D-2, SP40DDL, SP40DE, SP40DL, SP40E, SP45, SP45D, ST43DE...(Other models you can see in the webshop)		

			
1			
<b>GEV No.</b>	510224	<b>Ref. No.</b>	180831 36266
<b>description</b>	flat filter L 250mm W 265mm		
<b>For models:</b>	60EBT, C53DE, C53E, C60DE, C60E, C68DE, C68E, C68EBT, C6DE, C6E, C6EBT, DP45DE, DP45E, DP50DE, DP50E, DP50EBT, SP45DE, SP45E, SP50DE, SP50E, SP50E-400V3-50Hz-MARINE, SP50E-440V3-60Hz-MARINE, SP5DE, SP5E, SP68DE, SP68E, ST53DE, ST53E, ST60DE, ST60E, ST60EBT		

			
1			
<b>GEV No.</b>	510851	<b>Ref. No.</b>	33895
<b>description</b>	flat filter L 265mm W 200mm		
<b>For models:</b>	C81, C81E, C81EBT, CA55, CA90, CAP7, CAP7E, ED550, ED650E, RCA1100, SO55, SO55-400V3-50Hz-MARINE, SO55-440V3-60Hz-MARINE, SO55E, SP81, SP81E		

			
1			
<b>GEV No.</b>	512173	<b>Ref. No.</b>	35896
<b>description</b>	flat filter mounting pos. left		
<b>For models:</b>	60BT, 60BT-3, APS60, C6, C60, C60D, C6D, DP50, DP50D, DP50D-115V, FW50, RSP50, RSP50A, SD5BT, SP5, SP50, SP50-400V, SP50-440V, SP50D, SP5D, STS60, STS60D, TN-TDN5, TN-TDN6		

			
1			
<b>GEV No.</b>	512172	<b>Ref. No.</b>	35895
<b>description</b>	flat filter mounting pos. right		
<b>For models:</b>	60BT, 60BT-3, APS60, C6, C60, C60D, C6D, DP50, DP50D, DP50D-115V, FW50, RSP50, RSP50A, SD5BT, SP5, SP50, SP50-400V, SP50-440V, SP50D, SP5D, STS60, STS60D, TN-TDN5, TN-TDN6		

Зип Общепит

vsezip.ru

+7(812)987-08-81



1

<b>GEV No.</b>	512151	<b>Ref. No.</b>	32795
<b>description</b>	flat filter ø 192mm		
<b>For models:</b>	60BT, 60BT-3, APS60, APSE60, C6, C60, C60D, C6D, DP50, DP50D, DP50D-115V, FW50, RSP50, RSP50A, SD5BT, SP5, SP50, SP50-400V, SP50-440V, SP50D, SP5D, STS60, STS60D, TN-TDN5, TN-TDN6, VS-X313, VS-X313-LP-DOS, VS-X515, VS-X515-LP-DOS		



1

<b>GEV No.</b>	512354	<b>Ref. No.</b>	25020
<b>description</b>	protector		
<b>For models:</b>	CM52, CM60, CMD52, CMD60, E50, NK52, NK60, NKD52, NKD60, UNI53R, UNI53RD		



1

<b>GEV No.</b>	512352	<b>Ref. No.</b>	16105 u. 25068 16110
<b>description</b>	rectangular filter suction		
<b>For models:</b>	CM52, CMD52, CMD60, E50, M60, NK52, NKD52, NKD60, T5-80, T6-80, UNI53R, UNI53RD		



1

<b>GEV No.</b>	510914	<b>Ref. No.</b>	33459
<b>description</b>	round filters		
<b>For models:</b>	CA120, CA55, CA90, CAP7, CAP7E, ED550, ED650E, ED650S, RCA1100, RCA1200, RCA1200i, SO55, SO55-400V3-50Hz-MARINE, SO55-440V3-60Hz-MARINE, SO55E		



1

<b>GEV No.</b>	512215	<b>Ref. No.</b>	34430
<b>description</b>	round filters		
<b>For models:</b>	C81, C81E, C81EBT, C90, C90DE, C90E, C90EBT, C98, LO50, LO50E, LO62, RLO50, SMW15, SMW15E, SP81, SP81E, US-X501		



1

<b>GEV No.</b>	512147	<b>Ref. No.</b>	32719
<b>description</b>	round filter ø 151mm H 63mm		
<b>For models:</b>	60BT, 60BT-3, APS60, APSE60, C6, C60, C60D, C6D, DP50, DP50D, DP50D-115V, FW50, RSP50, RSP50A, SD5BT, SP5, SP50, SP50-400V, SP50-440V, SP50D, SP5D, STS60, STS60D, TN-TDN5, TN-TDN6, VS-X313, VS-X313-LP-DOS, VS-X515, VS-X515-LP-DOS		

<b>accessories for</b>	512147		
	<b>GEV No.</b>	512148	<b>Ref. No.</b>
			32717
	gasket		



1

<b>GEV No.</b>	512152	<b>Ref. No.</b>	32796
<b>description</b>	round filters ø 197mm		
<b>For models:</b>	60BT, 60BT-3, APS60, APSE60, C6, C60, C60D, C6D, DP50, DP50D, DP50D-115V, FW50, RSP50, RSP50A, SD5BT, SP5, SP50, SP50-400V, SP50-440V, SP50D, SP5D, STS60, STS60D, TN-TDN5, TN-TDN6, VS-X313, VS-X313-LP-DOS, VS-X515, VS-X515-LP-DOS		



1

<b>GEV No.</b>	511333	<b>Ref. No.</b>	180818 H180818
<b>description</b>	round filters ø 240mm H 95mm		
<b>For models:</b>	CAP10, CAP10BT, CAP10DE, CAP12, CAP12DE, CAP12EBT, CAP7E, HT100, HT150, HTP195, HTP205, HTP220, SO100, SO100-400V3-50Hz-MARINE, SO100-440V3-60Hz-MARINE, SO120		



1

<b>GEV No.</b>	519463	<b>Ref. No.</b>	180816 H180816
<b>description</b>	round filters ø 80mm H 72mm		
<b>For models:</b>	AC101, AC151, AC181, AC201, AC241, AC91, EDI13-2, EDI13ALTA-2, EDI13ALTABT, EDI13BT, EDI6-2, EDI6BT, EDI8-2, EDI8BT, EDT100, EDT140, EDT170, EDT200, EDT230, EDT85, HD130BT, HD60BT, HD80BT, LO134-2, LO134ALTA-2, LO67-2, LO83-2, TR100, TR140, TR170, TR200, TR230, TR90, TR-E100, TR-E150, TR-E170, TR-E200, TR-E230, TR-E90		



1

<b>GEV No.</b>	512335 <sup>1</sup>	<b>Ref. No.</b>	31622
<b>description</b>	round filters outflow ø 24mm H 90mm		
<b>For models:</b>	AP43E, AP48E, APS43, APS48, APS48B, APS53, APS60, APSE43, APSE48, APSE53, APSE60, BPN48, BPS43, BPS52, FW35, FW35E, FW40, FW40B, FW40E, FW45, FW50		

<sup>1</sup>for drain pump







Zip Общепит  
vsezip.ru  
7(812)987-08-81

			
1			
<b>GEV No.</b>	512334	<b>Ref. No.</b>	30839
<b>description</b>	round filters safety filter ø 39mm H 12mm		
<b>For models:</b>	APS43, APS48, APS48B, APS53, APS60, APSE43, APSE48, APSE53, APSE60, BPS43, FW35, FW40, FW40B, FW45, FW50		

			
1			
<b>GEV No.</b>	512171	<b>Ref. No.</b>	25021 34557
<b>description</b>	round filters suction ø 70mm H 86mm		
<b>For models:</b>	C35, C43, C43D, C48, C48D, CDN3, CDN4, CM43, CMD43, CR43, CR43D, CR48, CR48D, E36, E40, E43, NK43, NKD43, SP35, SP35D, SP40, SP40D, SPB35, SPR36, SPR36D, SPR41, SPR41D, UNI43R, UNI43RD		

			
1			
<b>GEV No.</b>	512137	<b>Ref. No.</b>	25021
<b>description</b>	round filters suction		

			
1			
<b>GEV No.</b>	512136	<b>Ref. No.</b>	25179 25789
<b>description</b>	wing nuts for filter		
<b>For models:</b>	C35, C43, C43D, C48, C48D, C53, C53D, C60, C60D, CM43, CM48, CM52, CMD43, CMD48, CMD52, CMD60, CR43, CR43D, CR48, CR48D, E36, E40, E43, E50, EDI13, EDI13ALTA, EDI6, EDI8, LO134, LO134ALTA, LO67, LO83, M60, NK43, NK48, NK52, NKD43, NKD48, NKD52, NKD60, RLO200, RLO300, RLO400, SP35, SP35D, SP40, SP40D, SP45, SP45D, SP50...(Other models you can see in the webshop)		

			
1			
<b>GEV No.</b>	512112	<b>Ref. No.</b>	31620
<b>description</b>	round filters suction ø 40mm H 47mm		
<b>For models:</b>	BPN48, BPS43, BPS52, C53, C53D, DP35, DP35D, DP40, DP40D, DP45, DP45D, INDY43F, INDY48F, SP45, SP45D, STS43, STS43D, STS48, STS48D, STS53, STS53D, UNI43C, UNI48C, UNI48CD, UNI53C, UNI60C		

<b>overflow pipes</b>			
			
1			
<b>GEV No.</b>	512028	<b>Ref. No.</b>	29466
<b>description</b>	funnel for overflow pipe suitable for HOONVED		
<b>For models:</b>	ED600-95, ED700-90, ED900-90, EDI5, LO122, LO60, LO61, LO78		

			
1			
<b>GEV No.</b>	512337	<b>Ref. No.</b>	34556
<b>description</b>	round filters suction ø 63mm H 87mm		
<b>For models:</b>	C43-2, C43ALTA, C43DE, C43E, C46DE, C46E, C48-2, C48D-2, C48DDL, C48DL, C48E, C53, C53D, DP35, DP35-2, DP35D, DP35D-2, DP40, DP40-2, DP40D, DP40D-2, DP40D-rib2, DP40-rib2, DP45, DP45D, GS-X1011, GS-X1011-2, GS-X1011-WEH, GS-X1011-WEH-2, GS-X1021, GS-X1021-2, GS-X1021-2rib, GS-X1021-WEH, GS-X1021-WEH-2, GS-X1021-WEH-2rib, RSP40, RSP40A, SP35-2, SP35ALTA, SP35DE, SP35E, SP40-2, SP40D-2, SP40DDL, SP40DE, SP40DL, SP40E, SP45, SP45D, ST43DE...(Other models you can see in the webshop)		

			
1			
<b>GEV No.</b>	510227	<b>Ref. No.</b>	200950 H200950
<b>description</b>	gasket Viton ID ø 27mm ED ø 44mm H 7mm		
<b>For models:</b>	C90DE2, C90E2, C90EBT2, CAP10, CAP10BT, CAP10DE, CAP12, CAP12DE, CAP12EBT, CAP15EBT, CAP7E, EDI4, HD40ALTABT, HD40BT, HT100, HT150, HTP195, HTP205, HTP220, LO56, SO100, SO100-400V3-50Hz-MARINE, SO100-440V3-60Hz-MARINE, SO120		

			
1			
<b>GEV No.</b>	512351	<b>Ref. No.</b>	25022
<b>description</b>	round filters suction ø 70mm H 116mm		
<b>For models:</b>	CM48, CMD48, NK48, NKD48, UNI48R, UNI48RD		

			
1			
<b>GEV No.</b>	511322	<b>Ref. No.</b>	200869 30479
<b>description</b>	O-ring EPDM thickness 3.53mm ID ø 20.22mm Qty 1 pcs		
<b>For models:</b>	60EBT, AP53E, AP60E, C35E, C43-2, C43ALTA, C43DE, C43E, C46DE, C46E, C48-2, C48D-2, C48DDL, C48DL, C48E, C53, C53D, C53DE, C53E, C60DE, C60E, C68DE, C68E, C68EBT, C6DE, C6E, C6EBT, DP35, DP35-2, DP35D, DP35D-2, DP40, DP40-2, DP40D, DP40D-2, DP40D-rib2, DP40-rib2, DP45, DP45D, DP45DE, DP45E, DP50DE, DP50E, DP50EBT, ED700-90, ED900-90, GS-X1011, GS-X1011-2, GS-X1011-WEH, GS-X1011-WEH-2...(Other models you can see in the webshop)		

Зип Общепит

vsezip.ru

+7(812)987-08-81



1

<b>GEV No.</b>	512168	<b>Ref. No.</b>	25014
<b>description</b>	overflow pipe L 102mm ø 25mm		
<b>For models:</b>	CM48, CMD48, NK48, NKD48, UNI48R, UNI48RD		



1

<b>GEV No.</b>	512106	<b>Ref. No.</b>	21078 21078/R
<b>description</b>	overflow pipe L 105mm ø 26mm		
<b>For models:</b>	C3, C4, C43ALTA, C48DDL, C48DL, DP35, DP35D, DP40, DP40D, E40-2F, GS-X1011, GS-X1011-WEH, INDY43F, INDY48F, SP35ALTA, SP40DDL, SP40DL, STS43, STS43D, STS48, STS48D, TS43, TS48, UNI43C, UNI48C, UNI48CD		



1

<b>GEV No.</b>	512169	<b>Ref. No.</b>	25015
<b>description</b>	overflow pipe L 113mm ø 25mm		
<b>For models:</b>	CM52, CMD52, E50, NKD52, T3-80, T4-80, UNI53R, UNI53RD		



1

<b>GEV No.</b>	510028	<b>Ref. No.</b>	180730 36395
<b>description</b>	overflow pipe L 120mm ø 26mm		
<b>For models:</b>	60EBT, C53DE, C53E, C60DE, C60E, C68DE, C68E, C68EBT, C6DE, C6E, C6EBT, DP45DE, DP45E, DP50DE, DP50E, DP50EBT, SP45DE, SP45E, SP50DE, SP50E, SP50E-400V3-50Hz-MARINE, SP50E-440V3-60Hz-MARINE, SP5DE, SP5E, SP68DE, SP68E, ST53DE, ST53E, ST60DE, ST60E, ST60EBT		
<b>accessories for</b>	510028		



<b>GEV No.</b>	511321	<b>Ref. No.</b>	180725 30424
<b>description</b>	lid for overflow pipe		



<b>GEV No.</b>	511322	<b>Ref. No.</b>	200869 30479
<b>description</b>	O-ring EPDM thickness 3.53mm ID ø 20.22mm Qty 1 pcs		



1

<b>GEV No.</b>	512107	<b>Ref. No.</b>	21286 21286/R
<b>description</b>	overflow pipe L 120mm ø 40mm		
<b>For models:</b>	C43ALTA, C48DDL, C48DL, C53, C53D, DP45, DP45D, SP35ALTA, SP40DDL, SP40DL, SP45, SP45D, STS53, STS53D, TN-TDN5, TN-TDN6, UNI53C, UNI60C		



1

<b>GEV No.</b>	512141	<b>Ref. No.</b>	33735
<b>description</b>	overflow pipe L 125mm ø 36mm		
<b>For models:</b>	C35, C43, C43D, C48, C48D, CDN3, CDN4, CR43, CR43D, CR48, CR48D, SP35, SP35D, SP40, SP40D, SPB35, SPR36, SPR36D, SPR41, SPR41D		



1

<b>GEV No.</b>	510437	<b>Ref. No.</b>	25012 25016
<b>description</b>	overflow pipe L 143mm ø 35mm		
<b>For models:</b>	CM60, CMD60, M60, NK60, NKD60, T5-80, T6-80		



1

<b>GEV No.</b>	512144	<b>Ref. No.</b>	18903
<b>description</b>	overflow pipe L 150mm ø 35mm		
<b>For models:</b>	C60, C60D, DP50, DP50D, SP50, SP50-400V, SP50-440V, SP50D, STS60, STS60D, VS-X313, VS-X313-LP-DOS, VS-X515, VS-X515-LP-DOS		





1

<b>GEV No.</b>	512338	<b>Ref. No.</b>	34485
<b>description</b>	overflow pipe L 160mm ø 35mm		
<b>For models:</b>	60BT, 60BT-3, C6, C60, C60D, C6D, DP50, DP50D, DP50D-115V, RSP50, RSP50A, SD5BT, SP5, SP50, SP50-400V, SP50-440V, SP50D, SP5D, STS60, STS60D, TN-TDN5, TN-TDN6, VS-X313, VS-X313-LP-DOS, VS-X515, VS-X515-LP-DOS		



Зип Общепит  
vsezip.ru  
+7(812)987-0888

			
1			
<b>GEV No.</b>	515046	<b>Ref. No.</b>	180708 33528
<b>description</b>	overflow pipe L 190mm ø 37mm		
<b>For models:</b>	C81, C81E, CA120, CA55, CA90, CAP7, CAP7E, ED550, ED650E, ED650S, RCA1100, RCA1200, RCA1200i, SO55, SO55-400V3-50Hz-MARINE, SO55-440V3-60Hz-MARINE, SO55E, SP81, SP81E		

			
1			
<b>GEV No.</b>	517620	<b>Ref. No.</b>	36045
<b>description</b>	overflow pipe L 225mm ø 40mm		
<b>For models:</b>	C98, LO62		

			
1			
<b>GEV No.</b>	512128	<b>Ref. No.</b>	20924
<b>description</b>	overflow pipe L 247mm ø 40mm		
<b>For models:</b>	ED650E, ED650E-90, ED650S-90		

			
1			
<b>GEV No.</b>	510645	<b>Ref. No.</b>	H180729
<b>description</b>	overflow pipe L 283mm ø 42mm		
<b>For models:</b>	CAP10, CAP10BT, CAP12, SO100, SO100-400V3-50Hz-MARINE, SO100-440V3-60Hz-MARINE, SO120		
<b>accessories for</b>	510645		
	<b>GEV No.</b>	510227	<b>Ref. No.</b>
			200950 H200950
gasket Viton ID ø 27mm ED ø 44mm H 7mm			

			
1			
<b>GEV No.</b>	512342	<b>Ref. No.</b>	20923
<b>description</b>	overflow pipe L 290mm ø 40mm		
<b>For models:</b>	ED630-90, ED650S		

			
1			
<b>GEV No.</b>	512095	<b>Ref. No.</b>	21521 21521/R
<b>description</b>	overflow pipe L 360mm ø 170mm tube ø 40mm		
<b>For models:</b>	ED600-90, ED700-90, ED800-90, EDI5, LO122, LO60, LO61, LO78		

			
1			
<b>GEV No.</b>	517619	<b>Ref. No.</b>	34865
<b>description</b>	overflow pipe L 455mm ø 40mm SS ID ø 34mm		
<b>For models:</b>	EDI13, EDI13ALTA, EDI6, EDI8, LO134, LO134ALTA, LO67, LO83, RLO200, RLO300, RLO400		

			
1			
<b>GEV No.</b>	512341	<b>Ref. No.</b>	25013
<b>description</b>	overflow pipe L 81mm ø 25mm		
<b>For models:</b>	CM43, CMD43, E36, E40, E43, NK43, NKD43, UNI43R, UNI43RD		

			
1			
<b>GEV No.</b>	517621	<b>Ref. No.</b>	30423
<b>description</b>	overflow pipe L 97mm ø 56mm tube ø 26mm plastic ID ø 18mm		
<b>For models:</b>	C43ALTA, C48DDL, C48DL, GS-X1011, GS-X1011-WEH, SP35ALTA, SP40DDL, SP40DL		

			
1			
<b>GEV No.</b>	517779	<b>Ref. No.</b>	21452
<b>description</b>	overflow pipe with filter		

containers

salt tanks



1

<b>GEV No.</b>	524177	<b>Ref. No.</b>	25034
<b>description</b>	lid $\varnothing$ 69mm H 20mm for salt tank ID $\varnothing$ 50mm		
<b>For models:</b>	C43D, C43DE, C46DE, C46E, C48D, C48D-2, C48DDL, C48E, C53D, C53DE, C60D, C60DE, C68DE, C68E, C6D, C6DE, C90DE, C90DE2, CAP10DE, CAP12DE, CDN3, CDN4, CMD43, CMD48, CMD52, CMD60, CR43D, CR48D, DP35D, DP35D-2, DP40D, DP40D-2, DP40D-rib2, DP45D, DP45DE, DP50D, DP50D-115V, DP50DE, GS-X1011, GS-X1011-2, GS-X1011-WEH, GS-X1011-WEH-2, GS-X1021, GS-X1021-2, GS-X1021-2rib, GS-X1021-WEH, GS-X1021-WEH-2, GS-X1021-WEH-2rib, NKD43, NKD48...(Other models you can see in the webshop)		
<b>accessories for</b>	524177		
	<b>GEV No.</b>	524148	<b>Ref. No.</b> —
	O-ring EPDM thickness 3.53mm ID $\varnothing$ 40.86mm Qty 1 pcs		



1

<b>GEV No.</b>	510018	<b>Ref. No.</b>	26033
<b>description</b>	nut $\varnothing$ 92mm H 10.5mm for salt tank ID $\varnothing$ 64mm		







Зип Общепит

vsezip.ru

+7(812)987-08-81



1

<b>GEV No.</b>	510929	<b>Ref. No.</b>	20151 25051
<b>description</b>	salt tank $\varnothing$ 120mm H 117mm hose $\varnothing$ 10mm mounting $\varnothing$ 70mm overall height 157mm		
<b>For models:</b>	C43D, C48D, C48D-2, C48DDL, C48E, C53D, C53DE, C60D, C60DE, C68DE, C68E, C6D, C6DE, C90DE, C90DE2, CDN3, CDN4, CMD43, CMD48, CMD52, CMD60, CR43D, CR48D, DP35D, DP35D-2, DP40D, DP40D-2, DP40D-rib2, DP45D, DP45DE, DP50D, DP50D-115V, DP50DE, GS-X1011, GS-X1011-2, GS-X1011-WEH, GS-X1011-WEH-2, GS-X1021, GS-X1021-2, GS-X1021-2rib, GS-X1021-WEH, GS-X1021-WEH-2, GS-X1021-WEH-2rib, NKD43, NKD48, NKD52, NKD60, RSP40A, RSP50A, SP35D...(Other models you can see in the webshop)		
<b>spare parts for</b>	510929		
	<b>GEV No.</b>	506015	<b>Ref. No.</b> 25246
	O-ring EPDM thickness 3.53mm ID $\varnothing$ 39.69mm Qty 1 pcs		
	<b>GEV No.</b>	510018	<b>Ref. No.</b> 26033
	nut $\varnothing$ 92mm H 10.5mm for salt tank ID $\varnothing$ 64mm		
	<b>GEV No.</b>	524177	<b>Ref. No.</b> 25034
	lid $\varnothing$ 69mm H 20mm for salt tank ID $\varnothing$ 50mm		
<b>accessories for</b>	510929		
	<b>GEV No.</b>	510071	<b>Ref. No.</b> —
	flat gasket rubber ED $\varnothing$ 81mm ID $\varnothing$ 68mm thickness 3mm for salt tank Qty 1 pcs		
	<b>GEV No.</b>	510654	<b>Ref. No.</b> —
	gasket H 6mm D1 $\varnothing$ 82mm D2 $\varnothing$ 68mm		
	<b>GEV No.</b>	510883	<b>Ref. No.</b> 25265
	gasket rubber ED $\varnothing$ 86mm ID $\varnothing$ 66mm thickness 2mm for salt tank Qty 1 pcs		

accessories



1

<b>GEV No.</b>	512375	<b>Ref. No.</b>	21679 333013
<b>description</b>	filter for rinse aid container		
<b>For models:</b>	60EBT, AP43E, AP48E, AP53E, AP60E, C35, C35E, C43, C43ALTA, C43D, C43DE, C43E, C46DE, C46E, C48, C48D, C48DDL, C48DL, C53, C53D, C53DE, C53E, C60, C60D, C60DE, C60E, C68DE, C68E, C6DE, C6E, C81E, C81EBT, C90DE2, C90E2, C90EBT, C90EBT2, C98, CAP10, CAP10BT, CAP10DE, CAP12, CAP12DE, CAP12EBT, CAP7, CAP7E, CR43, CR43D, CR48, CR48D, DP35...(Other models you can see in the webshop)		



Зип Общепит

boilers

boilers for dishwashers

vsezip.ru

+7(812)987-08-81

 <p>1</p>			
<b>GEV No.</b>	510883	<b>Ref. No.</b>	25265
<b>description</b>	gasket rubber ED ø 86mm ID ø 66mm thickness 2mm for salt tank Qty 1 pcs		
<b>For models:</b>	C43D, C48D, C48D-2, C48DDL, C48E, C53D, C53DE, C60D, C60DE, C68DE, C68E, C6D, C6DE, C90DE2, CDN3, CDN4, CMD43, CMD48, CMD52, CR43D, CR48D, DP35D, DP35D-2, DP40D, DP40D-2, DP40D-rib2, DP45D, DP50D, DP50D-115V, GS-X1011, GS-X1011-2, GS-X1011-WEH, GS-X1011-WEH-2, GS-X1021, GS-X1021-2, GS-X1021-2rib, GS-X1021-WEH, GS-X1021-WEH-2, GS-X1021-WEH-2rib, NKD43, NKD48, NKD52, RSP40A, RSP50A, SP35D, SP40D, SP40D-2, SP40DDL, SP40E, SP45D...(Other models you can see in the webshop)		

 <p>1</p>			
<b>GEV No.</b>	524178	<b>Ref. No.</b>	25033
<b>description</b>	nut for salt tank		
<b>For models:</b>	C43D, C43DE, C46DE, C46E, C48D, C48D-2, C48DDL, C48E, C53D, C53DE, C60D, C60DE, C68DE, C68E, C6D, C6DE, C90DE, CAP10DE, CAP12DE, CDN3, CDN4, CMD43, CMD48, CMD52, CMD60, CR43D, CR48D, DP35D, DP35D-2, DP40D, DP40D-2, DP40D-rib2, DP45D, DP45DE, DP50D, DP50D-115V, DP50DE, GS-X1011, GS-X1011-2, GS-X1011-WEH, GS-X1011-WEH-2, GS-X1021, GS-X1021-2, GS-X1021-2rib, GS-X1021-WEH, GS-X1021-WEH-2, GS-X1021-WEH-2rib, NKD43, NKD48, NKD52...(Other models you can see in the webshop)		

 <p>1</p>			
<b>GEV No.</b>	510226	<b>Ref. No.</b>	180149 H180149
<b>description</b>	nut ø 65mm for backflow preventer		
<b>For models:</b>	60BT-3, 60EBT, C68EBT, C6EBT, C81EBT, C90EBT, C90EBT2, CAP10BT, CAP12EBT, CAP15EBT, DP50EBT, EDI13ALTABT, EDI13BT, EDI4, EDI6BT, EDI8BT, HD130BT, HD40ALTABT, HD40BT, HD60BT, HD80BT, HT100, HT150, HTP195, HTP205, HTP220, LO56, SD5BT, ST48EBT, ST60EBT		

 <p>1</p>			
<b>GEV No.</b>	512065	<b>Ref. No.</b>	21336
<b>description</b>	boiler		
<b>For models:</b>	UNI43C, UNI48C, UNI48CD, UNI53C, UNI60C		

 <p>1</p>			
<b>GEV No.</b>	512164	<b>Ref. No.</b>	20190
<b>description</b>	boiler		
<b>For models:</b>	CM43, CM48, CMD43, CMD48, E43, NK43, NK48, NKD43, NKD48, T3-80, T4-80, UNI43R, UNI43RD, UNI48R, UNI48RD		

 <p>1</p>			
<b>GEV No.</b>	512165	<b>Ref. No.</b>	21335
<b>description</b>	boiler		
<b>For models:</b>	E40-2F, INDY43F, INDY48F, TS43, TS48, UNI43C, UNI48C, UNI48CD, UNI53C, UNI60C		

 <p>1</p>			
<b>GEV No.</b>	512176	<b>Ref. No.</b>	330377 36713
<b>description</b>	boiler ø 125mm L 360mm flange 3 hole flange inlet ø 46		
<b>For models:</b>	C35E, C43DE, C43E, C46DE, C46E, SP35DE, SP35E, SP40DE, SP40E, ST43DE		

Зип Общепит  
vsezip.ru

7(812)987-08-81

			
1			
<b>GEV No.</b>	512181	<b>Ref. No.</b>	18693 35426
<b>description</b>	boiler ø 125mm L 370mm flange 3 hole flange		
<b>For models:</b>	C3, C35, C4, C43, C43-2, C43ALTA, C43D, C48, C48-2, C48D, C48D-2, C48DDL, C48DL, C48E, CDN3, CDN4, CR43, CR43D, CR48, CR48D, DP35, DP35D, DP35D-2, GS-X1011, GS-X1011-2, GS-X1011-WEH, GS-X1011-WEH-2, RSP40, RSP40A, SP35, SP35-2, SP35ALTA, SP35D, SP40, SP40-2, SP40D, SP40D-2, SP40DDL, SP40DL, SP40E, SPB35, SPR36, SPR36D, SPR41, SPR41D, STS43, STS43D, STS43D-2, STS48D-2		

			
1			
<b>GEV No.</b>	512000	<b>Ref. No.</b>	330342 33403
<b>description</b>	boiler ø 150mm L 500mm		
<b>For models:</b>	C81, C81E, C90, C90DE, C90E, CA120, CA55, CA90, CAP10, CAP10DE, CAP12, CAP12DE, CAP7, CAP7E, ED550, ED650E, ED650S, EDI5, LO50, LO50E, LO61, RCA1100, RCA1200, RCA1200i, RLO50, SMW15, SMW15E, SO100, SO100-400V3-50Hz-MARINE, SO100-440V3-60Hz-MARINE, SO120, SO55, SO55-400V3-50Hz-MARINE, SO55-440V3-60Hz-MARINE, SO55E, SP81, SP81E, US-X501		

			
1			
<b>GEV No.</b>	512204	<b>Ref. No.</b>	34216 34647
<b>description</b>	boiler ø 150mm L 340mm		
<b>For models:</b>	DP35, DP35D, DP40, DP40D, DP45, DP45D, DP50, GS-X1021, GS-X1021-WEH, STS43, STS43D, STS48, STS48D, STS53, STS53D, STS60, STS60D		

			
1			
<b>GEV No.</b>	512386	<b>Ref. No.</b>	18212
<b>description</b>	boiler ø 150mm L 540mm		
<b>For models:</b>	ED700-90, ED900-90, LO122, LO78		

			
1			
<b>GEV No.</b>	524450	<b>Ref. No.</b>	34596
<b>description</b>	boiler ø 150mm L 445mm inlet ø 11		
<b>For models:</b>	C53, C53D, C6, C60, C60D, C6D, DP40, DP45, DP45D, DP50, DP50D, DP50D-115V, RSP50, RSP50A, SP45, SP45D, SP5, SP50, SP50-400V, SP50-440V, SP50D, SP5D, STS48, STS53, STS53D, STS60, STS60D, TN-TDN6, VS-X313, VS-X313-LP-DOS, VS-X515, VS-X515-LP-DOS		

			
1			
<b>GEV No.</b>	511000	<b>Ref. No.</b>	330331 330342 330342 old H330342
<b>description</b>	boiler ø 160mm L 500mm capacity 10l flange 3 hole flange inlet ø 12		

			
1			
<b>GEV No.</b>	419063	<b>Ref. No.</b>	330368/1+05990 36558 36558/1 36558+05990
<b>description</b>	boiler ø 150mm L 450mm flange 3 hole flange inlet ø 58		
<b>For models:</b>	AP53E, AP60E, C53DE, C53E, C60DE, C60E, C68DE, C68E, C6DE, C6E, DP45DE, DP45E, DP50DE, DP50E, SP45DE, SP45E, SP50DE, SP50E, SP50E-400V3-50Hz-MARINE, SP50E-440V3-60Hz-MARINE, SP5DE, SP5E, SP68DE, SP68E, ST53DE, ST53E, ST60DE, ST60E		

			
1			
<b>GEV No.</b>	524998	<b>Ref. No.</b>	330320 H330320
<b>description</b>	boiler ø 160mm L 630mm flange 3 hole flange inlet ø 11		
<b>For models:</b>	AC101, AC91, EDT100, EDT85, TR100, TR90, TR-E100, TR-E150, TR-E90		



Зип Общепит

vsezip.ru

+7(812)987-08-81



1

<b>GEV No.</b>	524999	<b>Ref. No.</b>	330339 H330339
<b>description</b>	boiler with insulation ø 200mm L 630mm flange 3 hole flange inlet ø 1/2" IT		



1

<b>GEV No.</b>	524997	<b>Ref. No.</b>	330322 H330322
<b>description</b>	boiler with insulation ø 230mm L 640mm flange 3 hole flange inlet ø 1/2" IT		
<b>For models:</b>	AC201, AC241, EDT200, EDT230, HG2LR, HGLR, HTP195, HTP205, HTP220, TR200, TR230, TR-E200, TR-E230, TR-E90		

**gaskets**



1

<b>GEV No.</b>	698576	<b>Ref. No.</b>	30007
<b>description</b>	gasket L 31.5mm W 12mm H 4.5mm thickness 4mm		
<b>For models:</b>	APS43, APS48, APS48B, APS53, APS60, APSE43, APSE48, APSE53, APSE60, C35, C43, C43ALTA, C43D, C48, C48D, C48DDL, C48DL, C53, C53D, C60, C60D, CDN3, CDN4, CR43, CR43D, CR48, CR48D, DP35, DP35D, DP40, DP40D, DP45, DP45D, DP50, DP50D, FW35, FW40, FW40B, FW45, FW50, SP35, SP35ALTA, SP35D, SP40, SP40D, SP40DDL, SP40DL, SP45, SP45D, SP50...(Other models you can see in the webshop)		

**rotation plates**

rotation plates



1

<b>GEV No.</b>	524189	<b>Ref. No.</b>	20071 20071/R 25053
<b>description</b>	rotation plate		
<b>For models:</b>	CDN3, CDN4, CM43, CM48, CM52, CMD43, CMD48, CMD52, CR43, CR43D, CR48, CR48D, E36, E40, E43, NK43, NK48, NKD43, NKD48, SPR36, SPR36D, SPR41, UNI43R, UNI43RD, UNI48R, UNI48RD, UNI53R, UNI53RD		

rotation plate bearings



1

<b>GEV No.</b>	524191	<b>Ref. No.</b>	20140
<b>description</b>	bearing for rotation plate complete		
<b>For models:</b>	CM43, E36, E40, E43, NK43		



1

<b>GEV No.</b>	519420	<b>Ref. No.</b>	15233
<b>description</b>	spindle for rotation plate ø 19.5mm		
<b>For models:</b>	CDN3, CDN4, CM43, CM48, CMD43, CMD48, CR43, CR43D, CR48, CR48D, E36, E40, E43, NK43, NK48, NKD43, NKD48, SPR36, SPR36D, SPR41, SPR41D, UNI43R, UNI43RD, UNI48R, UNI48RD, UNI53R, UNI53RD		

**softener cartridges**

softening columns



1

<b>GEV No.</b>	530000	<b>Ref. No.</b>	25030
<b>description</b>	softener 4-fold L 380mm W 180mm		



1

<b>GEV No.</b>	530019	<b>Ref. No.</b>	H640212
<b>description</b>	softener double		
<b>For models:</b>	C90DE, C90DE2		



1

<b>GEV No.</b>	530021	<b>Ref. No.</b>	33590
<b>description</b>	softener triple		
<b>For models:</b>	C43D, C48D, C48D-2, C48DDL, C48E, C53D, C60D, C6D, CDN3, CDN4, CR43D, CR48D, DP35D, DP35D-2, DP40D, DP40D-2, DP40D-rib2, DP45D, DP50D, DP50D-115V, GS-X1011, GS-X1011-2, GS-X1011-WEH, GS-X1011-WEH-2, GS-X1021, GS-X1021-2, GS-X1021-2rib, GS-X1021-WEH, GS-X1021-WEH-2, GS-X1021-WEH-2rib, RSP40A, RSP50A, SP35D, SP40D, SP40D-2, SP40DDL, SP40E, SP45D, SP50D, SP5D, SPR36D, SPR41D, STS43D, STS43D-2, STS48D, STS48D-2, STS48D-rib2, STS53D, STS60D, TDN4-2rib...(Other models you can see in the webshop)		

## housing and bezels

## miscellaneous



1

<b>GEV No.</b>	504350	<b>Ref. No.</b>	602222 H620222
<b>description</b>	equipment foot for dishwasher L 135-230mm		
<b>For models:</b>	EDT100, EDT140, EDT170, EDT200, EDT230, EDT85, TR100, TR140, TR170, TR200, TR230, TR90		

## hood mechanics for dishwashers

## bolts



1

<b>GEV No.</b>	524378	<b>Ref. No.</b>	H340443
<b>description</b>	pin ED ø 12mm L 61mm thread M8x1.25 for dishwasher		
<b>For models:</b>	EDT100, EDT140, EDT170, EDT200, EDT230, EDT85, TR100, TR140, TR170, TR200, TR230, TR90, TR-E100, TR-E150, TR-E170, TR-E200, TR-E230		

## bushes



1

<b>GEV No.</b>	510817	<b>Ref. No.</b>	H160530
<b>description</b>	spacer bush for handle hood mechanics		
<b>For models:</b>	ED650E, ED650S		



1

<b>GEV No.</b>	510848	<b>Ref. No.</b>	H290821
<b>description</b>	spacer bush for switch hood mechanics		
<b>For models:</b>	C98, EDI5, LO61, LO62, RCA1100, RCA1200, RCA1200i		

## hood handle supports



1

<b>GEV No.</b>	510350	<b>Ref. No.</b>	33446
<b>description</b>	guide for hood handle		
<b>For models:</b>	CA120, CA55, CA90, CAP10, CAP10BT, CAP12, CAP7, CAP7E, ED550, ED650E, ED650S, RCA1100, RCA1200, RCA1200i, SO100, SO100-400V3-50Hz-MARINE, SO100-440V3-60Hz-MARINE, SO120, SO55, SO55-400V3-50Hz-MARINE, SO55-440V3-60Hz-MARINE, SO55E		

Зип Общепит

vsezip.ru

+7(812)987-0000

<b>GEV No.</b>	510868	<b>Ref. No.</b>	191013 33438
<b>description</b>	handle holder hood mechanics		
<b>For models:</b>	CA120, CA55, CA90, CAP10, CAP10BT, CAP10DE, CAP12, CAP12DE, CAP12EBT, CAP15EBT, CAP7, CAP7E, ED550, ED650E, ED650S, RCA1100, RCA1200, RCA1200i, SO100, SO100-400V3-50Hz-MARINE, SO100-440V3-60Hz-MARINE, SO120, SO55, SO55-400V3-50Hz-MARINE, SO55-440V3-60Hz-MARINE, SO55E		

<b>GEV No.</b>	510869	<b>Ref. No.</b>	191014 33439
<b>description</b>	handle holder hood mechanics		
<b>For models:</b>	CA120, CA55, CA90, CAP10, CAP10BT, CAP10DE, CAP12, CAP12DE, CAP12EBT, CAP15EBT, CAP7, CAP7E, ED550, ED650E, ED650S, RCA1100, RCA1200, RCA1200i, SO100, SO100-400V3-50Hz-MARINE, SO100-440V3-60Hz-MARINE, SO120, SO55, SO55-400V3-50Hz-MARINE, SO55-440V3-60Hz-MARINE, SO55E		

## miscellaneous

<b>GEV No.</b>	510864	<b>Ref. No.</b>	190607 33519
<b>description</b>	bush for spring holder hood mechanics		
<b>For models:</b>	CA120, CA55, CA90, CAP10, CAP10BT, CAP10DE, CAP12, CAP12DE, CAP12EBT, CAP15EBT, CAP7, CAP7E, ED550, ED650E, ED650S, RCA1100, RCA1200, RCA1200i, SO100, SO100-400V3-50Hz-MARINE, SO100-440V3-60Hz-MARINE, SO120, SO55, SO55-400V3-50Hz-MARINE, SO55-440V3-60Hz-MARINE, SO55E		

<b>GEV No.</b>	511393	<b>Ref. No.</b>	H190149
<b>description</b>	strengthening for handle holder hood mechanics		
<b>For models:</b>	CA120, CA55, CA90, CAP10, CAP10BT, CAP12, CAP7, CAP7E, ED550, ED650E, ED650S, RCA1100, RCA1200, RCA1200i, SO100, SO100-400V3-50Hz-MARINE, SO100-440V3-60Hz-MARINE, SO120, SO55, SO55-400V3-50Hz-MARINE, SO55-440V3-60Hz-MARINE, SO55E		





Зип Общепит



nut thread M10 H 8mm WS 17 SS DIN/ISO DIN 934 / ISO 4032/8673 Qty 1 pcs

+7(812)987-08-81

basket guides

guide bars



1			
<b>GEV No.</b>	510931	<b>Ref. No.</b>	191051 H191051
<b>description</b>	slide guide		
<b>For models:</b>	AC101, AC151, AC181, AC201, AC241, AC91, EDT100, EDT140, EDT170, EDT200, EDT230, EDT85, TR100, TR140, TR170, TR200, TR230, TR90, TR-E100, TR-E150, TR-E170, TR-E200, TR-E230		

miscellaneous



1			
<b>GEV No.</b>	512024	<b>Ref. No.</b>	H190620
<b>description</b>	guide L 44mm W 34mm H 20mm		



1			
<b>GEV No.</b>	511223	<b>Ref. No.</b>	H191019
<b>description</b>	sleeve for magnetic switch L 76mm ø 16mm thread M10x1.5 plastic		
<b>For models:</b>	EDT100, EDT140, EDT170, EDT200, EDT230, EDT85, TR100, TR140, TR170, TR200, TR230, TR90, TR-E90		

air traps

air traps



1			
<b>GEV No.</b>	510347	<b>Ref. No.</b>	161303 H161303
<b>description</b>	air trap		
<b>For models:</b>	C90DE, C90EBT, C98, CA55, CAP7, CAP7E, ED550, LO62, RCA1100, RCA1200, RCA1200i, SO55, SO55-400V3-50Hz-MARINE, SO55-440V3-60Hz-MARINE, SO55E		
<b>spare parts for</b>	510347		
	<b>GEV No.</b>	510877	<b>Ref. No.</b>
			200415 H200415
	flat gasket rubber ED ø 18mm ID ø 10mm thickness 3mm Qty 1 pcs		
	<b>GEV No.</b>	560197	<b>Ref. No.</b>
			26758
	nut thread M10 H 8mm WS 17 SS DIN/ISO DIN 934 / ISO 4032/8673 Qty 1 pcs		
<b>accessories for</b>	510347		
	<b>GEV No.</b>	510877	<b>Ref. No.</b>
			200415 H200415
	flat gasket rubber ED ø 18mm ID ø 10mm thickness 3mm Qty 1 pcs		

<b>accessories for</b>	510347		
<b>GEV No.</b>	560197	<b>Ref. No.</b>	26758
<b>description</b>	nut thread M10 H 8mm WS 17 SS DIN/ISO DIN 934 / ISO 4032/8673 Qty 1 pcs		



1			
<b>GEV No.</b>	510759	<b>Ref. No.</b>	161316 25010
<b>description</b>	air trap		
<b>For models:</b>	60BT, 60BT-3, 60EBT, C3, C35, C35E, C4, C43, C43-2, C43ALTA, C43D, C43DE, C43E, C46DE, C46E, C48, C48-2, C48D, C48D-2, C48DDL, C48DL, C48E, C53, C53D, C53DE, C53E, C6, C60, C60D, C60DE, C60E, C68DE, C68E, C68EBT, C6D, C6DE, C6E, C6EBT, CDN3, CDN4, CM43, CM48, CM52, CMD43, CMD48, CMD52, CR43, CR43D, CR48, CR48D... (Other models you can see in the webshop)		

<b>spare parts for</b>	510759		
	<b>GEV No.</b>	502036	<b>Ref. No.</b>
			200805 25239
	O-ring EPDM thickness 2.62mm ID ø 28.25mm Qty 1 pcs		

	<b>GEV No.</b>	510760	<b>Ref. No.</b>
			161317 25011
	hose connector		

	<b>GEV No.</b>	510761	<b>Ref. No.</b>
			25263
	flat gasket rubber D1 ø 38mm D2 ø 25mm thickness 2mm Qty 1 pcs		

<b>accessories for</b>	510759		
	<b>GEV No.</b>	510760	<b>Ref. No.</b>
			161317 25011
	hose connector		

	<b>GEV No.</b>	510761	<b>Ref. No.</b>
			25263
	flat gasket rubber D1 ø 38mm D2 ø 25mm thickness 2mm Qty 1 pcs		

	<b>GEV No.</b>	512283	<b>Ref. No.</b>
			—
	flat gasket rubber D1 ø 38.5mm D2 ø 24.5mm thickness 2mm Qty 1 pcs		





1			
<b>GEV No.</b>	511199	<b>Ref. No.</b>	131308 H161308
<b>description</b>	air trap		
<b>For models:</b>	EDI13ALTABT, EDI13BT, EDI4, EDI5, EDI6BT, EDI8BT, EDT100, EDT140, EDT170, EDT200, EDT230, EDT85, LO56, LO61, TR100, TR140, TR170, TR200, TR230, TR90, TR-E100, TR-E150, TR-E170, TR-E200, TR-E230, TR-E90		
<b>accessories for</b>	511199		
	<b>GEV No.</b>	511283	<b>Ref. No.</b>
			H200927
	flat gasket rubber ED ø 30mm ID ø 20mm thickness 2mm Qty 1 pcs		
	<b>GEV No.</b>	511284	<b>Ref. No.</b>
			270121 H270121
	nut		
	<b>GEV No.</b>	511286	<b>Ref. No.</b>
			—
	hose clamp ø 38mm wire gauge ø 3.2mm Qty 1 pcs		

Table continues overleaf

accessories for	511199		
	GEV No.	511289	Ref. No.
			—
	hose ED ø 9.5mm ID ø 5mm L 420mm equiv. no. 161312		

	1		
GEV No.	512258	Ref. No.	29640
description	air trap		
For models:	APS43, APS48, APS48B, APS53, APS60, APSE43, APSE48, APSE53, APSE60, FW35, FW40, FW40B, FW45, FW50		

	1		
GEV No.	512198	Ref. No.	180420
description	air trap L 70mm W 50mm ø 28mm hose ø 8.5mm		
For models:	C6EBT, C81EBT, CAP15EBT, EDI13ALTABT, EDI13BT, EDI6BT, EDI8BT, HT100, HT150, HTP195, HTP205, HTP220		

air trap accessories			
	1		
GEV No.	510761	Ref. No.	25263
description	flat gasket rubber D1 ø 38mm D2 ø 25mm thickness 2mm Qty 1 pcs		
For models:	60BT, 60BT-3, 60EBT, APS43, APS48, APS48B, APS53, APS60, APSE43, APSE48, APSE53, APSE60, BPN48, BPS43, BPS52, C3, C35, C35E, C4, C43, C43-2, C43ALTA, C43D, C43DE, C43E, C46DE, C46E, C48, C48-2, C48D, C48D-2, C48DDL, C48DL, C48E, C53, C53D, C53DE, C53E, C6, C60, C60D, C60DE, C60E, C68DE, C68E, C68EBT, C6D, C6DE, C6E, C6EBT...(Other models you can see in the webshop)		

	1		
GEV No.	510877	Ref. No.	200415 H200415
description	flat gasket rubber ED ø 18mm ID ø 10mm thickness 3mm Qty 1 pcs		
For models:	60EBT, AC101, AC151, AC181, AC201, AC241, AC91, C53DE, C53E, C6, C60DE, C60E, C68DE, C68E, C68EBT, C6D, C6DE, C6E, C6EBT, DP45DE, DP45E, DP50DE, DP50E, DP50EBT, EDT100, EDT140, EDT170, EDT200, EDT230, EDT85, HG2LR, HGLR, SP45DE, SP45E, SP5, SP50DE, SP50E, SP50E-400V3-50Hz-MARINE, SP50E-440V3-60Hz-MARINE, SP5D, SP5DE, SP5E, SP68DE, SP68E, ST53DE, ST53E, ST60DE, ST60E, ST60EBT		

	1		
GEV No.	511283	Ref. No.	H200927
description	flat gasket rubber ED ø 30mm ID ø 20mm thickness 2mm Qty 1 pcs		
For models:	C81E, CAP10, CAP10BT, CAP12, EDI13ALTABT, EDI13BT, EDI4, EDI5, EDI6BT, EDI8BT, EDT100, EDT140, EDT170, EDT200, EDT230, EDT85, LO56, LO61, SO100, SO100-400V3-50Hz-MARINE, SO100-440V3-60Hz-MARINE, SO120, SP81E, TR100, TR140, TR170, TR200, TR230, TR90, TR-E100, TR-E150, TR-E170, TR-E200, TR-E230, TR-E90		

Зип Общепит

vsezip.ru

+7(812)987-08-81

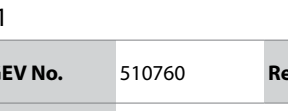
	1		
GEV No.	510760	Ref. No.	161317 25011
description	hose connector		
For models:	60BT, 60BT-3, 60EBT, APS43, APS48, APS48B, APS53, APS60, APSE43, APSE48, APSE53, APSE60, BPN48, BPS43, BPS52, C3, C35, C35E, C4, C43, C43-2, C43ALTA, C43D, C43DE, C43E, C46DE, C46E, C48, C48-2, C48D, C48D-2, C48DDL, C48DL, C48E, C53, C53D, C53DE, C53E, C6, C60, C60D, C60DE, C60E, C68DE, C68E, C68EBT, C6D, C6DE, C6E, C6EBT...(Other models you can see in the webshop)		

	1		
GEV No.	511284	Ref. No.	270121 H270121
description	nut		
For models:	AC101, AC151, AC181, AC201, AC241, AC91, C81E, C81EBT, C90DE2, C90E2, C90EBT2, CAP10, CAP10BT, CAP10DE, CAP12, CAP12DE, CAP12EBT, CAP15EBT, CAP7E, EDI13ALTABT, EDI13BT, EDI4, EDI5, EDI6BT, EDI8BT, EDT100, EDT140, EDT170, EDT200, EDT230, EDT85, HD130BT, HD40ALTABT, HD40BT, HD60BT, HD80BT, LO56, LO61, SO100, SO100-400V3-50Hz-MARINE, SO100-440V3-60Hz-MARINE, SO120, SP81E, TR100, TR140, TR170, TR200, TR230, TR90, TR-E100...(Other models you can see in the webshop)		

## mechanics for flight type dishwashers

	1		
GEV No.	529234	Ref. No.	620144 620648 H620144
description	drive shaft for transport system		
For models:	AC101, AC151, AC181, AC201, AC241, AC91, EDT100, EDT140, EDT170, EDT200, EDT230, EDT85, TR100, TR140, TR170, TR200, TR230, TR90, TR-E100, TR-E150, TR-E170, TR-E200, TR-E230		

	1		
GEV No.	504361	Ref. No.	H170238
description	lever L 95mm W 30mm H 35mm		



Zip Общепит

vsezip.ru



+7(812)987-08-81

			
1			
<b>GEV No.</b>	504346	<b>Ref. No.</b>	H170314
<b>description</b>	roller for transport system H 19.5mm ø 30mm hole ø 9mm		

backflow preventers

backflow preventers

			
1			
<b>GEV No.</b>	504265	<b>Ref. No.</b>	33506
<b>description</b>	backflow preventer		
<b>For models:</b>	C43-2, C43DE, C43E, C46DE, C46E, C48-2, C48D-2, C53DE, C6, C60DE, C68DE, C68E, C6D, C6DE, CA120, CA55, CA90, CAP10, CAP12, CAP7, DP35-2, DP35D-2, DP40-2, DP40D-2, DP40D-rib2, DP40-rib2, ED550, ED650E, ED650S, GS-X1011, GS-X1011-2, GS-X1011-WEH, GS-X1011-WEH-2, GS-X1021, GS-X1021-2, GS-X1021-2rib, GS-X1021-WEH, GS-X1021-WEH-2, GS-X1021-WEH-2rib, RCA1100, RCA1200, RCA1200i, SO100, SO100-400V3-50Hz-MARINE, SO100-440V3-60Hz-MARINE, SO120, SO55, SO55-400V3-50Hz-MARINE, SO55-440V3-60Hz-MARINE, SP35-2...(Other models you can see in the webshop)		

			
1			
<b>GEV No.</b>	510220	<b>Ref. No.</b>	191095 H191095
<b>description</b>	backflow preventer		
<b>For models:</b>	60BT-3, 60EBT, C68EBT, C6EBT, C81EBT, C90EBT, C90EBT2, CAP10BT, CAP12EBT, CAP15EBT, DP50EBT, EDI13ALTABT, EDI13BT, EDI4, EDI6BT, EDI8BT, LO56, SD5BT, ST48EBT, ST60EBT		
<b>accessories for</b>	510220		
	<b>GEV No.</b>	510226	<b>Ref. No.</b> 180149 H180149
	nut ø 65mm for backflow preventer		
	<b>GEV No.</b>	510234	<b>Ref. No.</b> —
	flat gasket rubber ED ø 65mm ID ø 47mm thickness 2mm Qty 1 pcs		

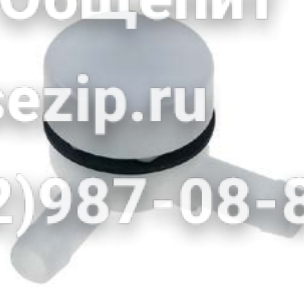
			
1			
<b>GEV No.</b>	512200	<b>Ref. No.</b>	620535 H620535
<b>description</b>	backflow preventer connection 12 90° hose ø 12mm		
<b>For models:</b>	AP43E, AP48E, AP53E, AP60E, C35E, C43-2, C43DE, C43E, C46DE, C46E, C48-2, C48D-2, C53DE, C53E, C6, C60DE, C60E, C68DE, C68E, C6D, C6DE, C6E, CA120, CA55, CA90, CAP10, CAP10DE, CAP12, CAP12DE, CAP7, CAP7E, DP45DE, DP45E, DP50DE, DP50E, ED550, ED650E, ED650S, FW35E, FW40E, SO100, SO120, SO55, SO55E, SP35DE, SP35E, SP40DE, SP40E, SP45DE, SP45E...(Other models you can see in the webshop)		

accessories

			
1			
<b>GEV No.</b>	511277	<b>Ref. No.</b>	33502
<b>description</b>	T-piece thread 1/2" ø 18mm		
<b>For models:</b>	C43-2, C43DE, C43E, C46DE, C46E, C48-2, C48D-2, C53DE, C6, C60DE, C68DE, C68E, C6D, C6DE, CA120, CA55, CA90, CAP10, CAP12, CAP7, DP35-2, DP35D-2, DP40-2, DP40D-2, DP40D-rib2, DP40-rib2, ED550, ED650E, ED650S, GS-X1011, GS-X1011-2, GS-X1011-WEH, GS-X1011-WEH-2, GS-X1021, GS-X1021-2, GS-X1021-2rib, GS-X1021-WEH, GS-X1021-WEH-2, GS-X1021-WEH-2rib, RCA1100, RCA1200, RCA1200i, SO100, SO100-400V3-50Hz-MARINE, SO100-440V3-60Hz-MARINE, SO120, SO55, SO55-400V3-50Hz-MARINE, SO55-440V3-60Hz-MARINE, SP35-2...(Other models you can see in the webshop)		

miscellaneous

			
1			
<b>GEV No.</b>	512063	<b>Ref. No.</b>	33505
<b>description</b>	gasket ID ø 21mm ED ø 30mm thickness 2mm		
<b>For models:</b>	C43-2, C43DE, C43E, C46DE, C46E, C48-2, C48D-2, C53, C53DE, C6, C60, C60DE, C68DE, C68E, C6D, C6DE, C90, CA120, CA55, CA90, CAP10, CAP12, CAP7, DP35-2, DP35D-2, DP40-2, DP40D-2, DP40D-rib2, DP40-rib2, ED550, ED650E, ED650S, EDI13, EDI13ALTA, EDI6, EDI8, GS-X1011, GS-X1011-2, GS-X1011-WEH, GS-X1011-WEH-2, GS-X1021, GS-X1021-2, GS-X1021-2rib, GS-X1021-WEH, GS-X1021-WEH-2, GS-X1021-WEH-2rib, LO134, LO134ALTA, LO50, LO67...(Other models you can see in the webshop)		



1

<b>GEV No.</b>	511394	<b>Ref. No.</b>	25032
<b>description</b>	lid for tank with thread D1 ø 88mm D2 ø 65mm		
<b>For models:</b>	APS43, APS48, APS48B, APS53, APS60, APSE43, APSE48, APSE53, APSE60, C35, C43, C43ALTA, C43D, C48, C48D, C48DDL, C48DL, C53, C53D, C60, C60D, CM43, CM48, CM52, CM60, CR43, CR43D, CR48, CR48D, DP35, DP35-2, DP35D, DP35D-2, DP40, DP40-2, DP40D, DP40D-2, DP40D-rib2, DP40-rib2, DP45, DP45D, DP50, DP50D, E40, E43, E50, FW35, FW40, FW40B, FW45...(Other models you can see in the webshop)		
<b>accessories for</b>	511394		
	<b>GEV No.</b>	<b>Ref. No.</b>	
	511395	25245	
	O-ring EPDM thickness 2.62mm ID ø 71.12mm Qty 1 pcs		
	<b>GEV No.</b>	<b>Ref. No.</b>	
	511396	25008	
	nut		



1

<b>GEV No.</b>	510349	<b>Ref. No.</b>	160755
<b>description</b>	plug D1 ø 87mm mounting ø 72mm ID ø 60mm		
<b>For models:</b>	60EBT, C43DE, C43E, C46DE, C46E, C53DE, C53E, C60DE, C60E, C68DE, C68E, C6DE, C6E, DP45DE, DP45E, DP50DE, DP50E, SP35DE, SP35E, SP40DE, SP40E, SP50DE, SP50E, ST53DE, ST53E, ST60DE, ST60E		
<b>accessories for</b>	510349		
	<b>GEV No.</b>	<b>Ref. No.</b>	
	510947	—	
	flat gasket rubber ED ø 85mm ID ø 73mm thickness 2mm Qty 1 pcs equiv. no. 200489 suitable for COMENDA		

## door mechanics

## bolts



1

<b>GEV No.</b>	502260	<b>Ref. No.</b>	15995
<b>description</b>	adaptor ø 7mm L 21.5mm thread M6 for door SS		
<b>For models:</b>	60BT, 60BT-3, APS43, APS48, APS48B, APS53, APS60, APSE43, APSE48, APSE53, APSE60, C3, C35, C4, C43, C43-2, C43ALTA, C43D, C48, C48-2, C48D, C48D-2, C48DDL, C48DL, C48E, C53, C53D, C6, C60, C60D, C6D, C81, C81E, C81EBT, C90, C90DE, C90DE2, C90E, C90E2, C90EBT, C90EBT2, C98, CDN3, CDN4, CR43, CR43D, CR48, CR48D, DP35, DP35-2...(Other models you can see in the webshop)		

## Зип Общепит

## vsezip.ru

## +7(812)9800081



1

<b>GEV No.</b>	511392	<b>Ref. No.</b>	33444
<b>description</b>	bearing bolt		
<b>For models:</b>	CA120, CA55, CA90, CAP7, CAP7E, ED550, ED650E, ED650S, RCA1100, RCA1200, RCA1200i, SO35, SO35-400V3-50Hz-MARINE, SO55-440V3-50Hz-MARINE, SO55E		

## springs

## tension springs



1

<b>GEV No.</b>	510064	<b>Ref. No.</b>	36860 450298
<b>description</b>	tension spring ø 13mm total length 78mm wire gauge ø 2.5mm L1 14mm L2 50mm L3 14mm		
<b>For models:</b>	60EBT, C60DE, C60E, C68DE, C68E, C68EBT, C6DE, C6E, C6EBT, SP50DE, SP50E, SP68DE, SP68E		

## linkage



1

<b>GEV No.</b>	512201	<b>Ref. No.</b>	34860
<b>description</b>	bar L 540mm thread M8x1.25 angled W 28.5mm ø 12mm		
<b>For models:</b>	EDI13, EDI13-2, EDI13ALTA, EDI13ALTA-2, EDI13BT, EDI6, EDI6-2, EDI6BT, EDI8, EDI8-2, EDI8BT, HD130BT, HD40ALTABT, HD40BT, HD60BT, HD80BT, LO134, LO134-2, LO134ALTA, LO134ALTA-2, LO67, LO67-2, LO83, LO83-2, RLO200, RLO300, RLO400		



1

<b>GEV No.</b>	512370	<b>Ref. No.</b>	34142
<b>description</b>	door pin tie bar		
<b>For models:</b>	APS43, APS48, APS48B, APS53, C35, C43, C43-2, C43ALTA, C43D, C48, C48-2, C48D, C48D-2, C48DDL, C48DL, C48E, C53, C53D, C60, C60D, CDN3, CDN4, CR43, CR43D, CR48, CR48D, DP35, DP35-2, DP35D, DP35D-2, DP40, DP40-2, DP40D, DP40D-2, DP40D-rib2, DP40-rib2, DP45, DP45D, FW35, FW40, FW40B, FW45, GS-X1011, GS-X1011-2, GS-X1011-WEH, GS-X1011-WEH-2, GS-X1021, GS-X1021-2, GS-X1021-2rib, GS-X1021-WEH...(Other models you can see in the webshop)		



<b>GEV No.</b>	519413	<b>Ref. No.</b>	34827
<b>description</b>	end stop for tie bar		
<b>For models:</b>	C90, LO50, RLO50, US-X501		



1

<b>GEV No.</b>	519412	<b>Ref. No.</b>	34440
<b>description</b>	tie bar L 234mm thread M5 ø 4.4mm		
<b>For models:</b>	C81, C90, LO50, RLO50, SP81, US-X501		





Зип Общепит

vsezip.ru

7(812)987-08-81



1 			
<b>GEV No.</b>	512026	<b>Ref. No.</b>	34144
<b>description</b>	tie bar L 235mm thread M5		
<b>For models:</b>	60BT, 60BT-3, APS48, APS48B, APS60, C48, C48D, C48DDL, C53, C53D, C6, C60, C60D, C6D, CR48, CR48D, DP50, DP50D, DP50D-115V, FW40, FW50, RSP50, RSP50A, SD5BT, SP5, SP50, SP50-400V, SP50-440V, SP50D, SP5D, STS60, STS60D, TN-TDN6, VS-X313, VS-X313-LP-DOS, VS-X515, VS-X515-LP-DOS		

threaded shafts			
1 			
<b>GEV No.</b>	512371	<b>Ref. No.</b>	34143
<b>description</b>	threaded part threaded part		
<b>For models:</b>	60BT, 60BT-3, APS43, APS48, APS48B, APS53, APS60, C35, C43, C43-2, C43ALTA, C43D, C48, C48-2, C48D, C48D-2, C48DDL, C48DL, C48E, C53, C53D, C6, C60, C60D, C6D, C81, C90, CDN3, CDN4, CR43, CR43D, CR48, CR48D, DP35, DP35-2, DP35D, DP35D-2, DP40, DP40-2, DP40D, DP40D-2, DP40D-rib2, DP40-rib2, DP45, DP45D, DP50, DP50D, DP50D-115V, FW35, FW40...(Other models you can see in the webshop)		

sliding plates			
1 			
<b>GEV No.</b>	510492	<b>Ref. No.</b>	160905 H331461
<b>description</b>	sliding plate for tie bar		
<b>For models:</b>	60BT, 60BT-3, APS43, APS48, APS48B, APS53, APS60, C35, C43, C43-2, C43ALTA, C43D, C48, C48-2, C48D, C48D-2, C48DDL, C48DL, C48E, C53, C53D, C6, C60, C60D, C6D, CDN3, CDN4, CR43, CR43D, CR48, CR48D, DP35, DP35-2, DP35D, DP35D-2, DP40, DP40-2, DP40D, DP40D-2, DP40D-rib2, DP40-rib2, DP45, DP45D, DP50, DP50D, DP50D-115V, FW35, FW40, FW40B, FW45...(Other models you can see in the webshop)		

1 			
<b>GEV No.</b>	511371	<b>Ref. No.</b>	H160909
<b>description</b>	sliding plate sliding plate		
<b>For models:</b>	APS43, APS48, APS48B, APS53, APS60, C81, C90, DP35, DP35-2, DP35D, DP35D-2, DP40, DP40-2, DP40D, DP40D-2, DP40D-rib2, DP40-rib2, DP45, DP45D, DP50, DP50D, FW35, FW40, FW40B, FW45, FW50, LO50, RLO50, SP81, STS43, STS43-2, STS43D, STS43D-2, STS48, STS48-2, STS48D, STS48D-2, STS48D-rib2, STS48-rib2, STS53, STS53D, STS60, STS60D, US-X501		

1 			
<b>GEV No.</b>	501444	<b>Ref. No.</b>	37339 450250+324170+190685
<b>description</b>	door hinge kit HOONVED		
<b>For models:</b>	AP43E, AP48E, AP53E, AP60E, DP45DE, DP45E, DP50DE, DP50E, FW35E, FW40E, ST43DE, ST43E, ST48DE, ST48E, ST53DE, ST53E, ST60DE, ST60E		

1 			
<b>GEV No.</b>	501443	<b>Ref. No.</b>	324170
<b>description</b>	door hinge L 150mm HOONVED		
<b>For models:</b>	AP43E, AP48E, AP53E, AP60E, DP45DE, DP45E, DP50DE, DP50E, DP50EBT, FW35E, FW40E, ST43DE, ST43E, ST48DE, ST48E, ST48EBT, ST53DE, ST53E, ST60DE, ST60E, ST60EBT		
<b>spare parts for</b>	501443		
	<b>GEV No.</b>	512405	<b>Ref. No.</b> 190685
bush for door hinge plastic ø 10mm L 9mm			

hinge pins			
1 			
<b>GEV No.</b>	511375	<b>Ref. No.</b>	15568 342087 H15568
<b>description</b>	hinge pin ø 6mm D1 ø 4mm L 55mm thread M4 stainless steel		
<b>For models:</b>	60BT, 60BT-3, 60EBT, APS43, APS48, APS48B, APS53, APS60, C35, C35E, C43, C43-2, C43ALTA, C43D, C43DE, C43E, C46DE, C46E, C48, C48-2, C48D, C48D-2, C48DDL, C48DL, C48E, C53, C53D, C53DE, C53E, C6, C60, C60D, C60DE, C60E, C68DE, C68E, C68EBT, C6D, C6DE, C6E, C81, C81E, C81EBT, C90, C90DE, C90DE2, C90E, C90E2, C90EBT, C90EBT2...(Other models you can see in the webshop)		

1 			
<b>GEV No.</b>	511628	<b>Ref. No.</b>	H341927
<b>description</b>	hinge pin ø 6mm L 60mm thread M6x1 stainless steel		
<b>For models:</b>	C53DE, C53E, C60DE, C60E, SP45DE, SP45E, SP50DE, SP50E		

## doors



1

<b>GEV No.</b>	524533	<b>Ref. No.</b>	36898 37531+200217+323724+323725+2x450
<b>description</b>	door kit for dishwasher W 589mm H 451mm		
<b>For models:</b>	60EBT, C53E, C60DE, C60E, C6DE, C6E, SP50DE, SP50E, SP50E-400V3-50Hz RINE, SP50E-440V3-60Hz-MARINE, SP5DE, SP5E		

Зип Общепит

vsezip.ru

+7(812)987 08 81



1

<b>GEV No.</b>	512369	<b>Ref. No.</b>	25052
<b>description</b>	counterpart door catch		
<b>For models:</b>	CM43, CM48, CM52, CM60, CMD43, CMD48, CMD52, CMD60, E36, E40, E40-2F, E43, E50, K80F, K80G, M60, NK43, NK48, NK52, NK60, NKD43, NKD48, NKD52, NKD60, T3-80, T4-80, T5-80, T6-80, TS43, TS48		



1

<b>GEV No.</b>	512160	<b>Ref. No.</b>	20018
<b>description</b>	door catch		
<b>For models:</b>	CM43, CM48, CM52, CM60, CMD43, CMD48, CMD52, CMD60, E36, E40, E40-2F, E43, E50, K80F, K80G, M60, NK43, NK52, NK60, NKD43, NKD48, NKD52, NKD60, T3-80, T4-80, T5-80, T6-80, TS43, TS48		

<b>accessories for</b>	512160	<b>GEV No.</b>	512369	<b>Ref. No.</b>	25052

## door bumpers



1

<b>GEV No.</b>	510957	<b>Ref. No.</b>	190619 H190619
<b>description</b>	door bumper end stop		
<b>For models:</b>	60BT, 60BT-3, APS43, APS48, APS48B, APS53, APS60, C35, C43, C43-2, C43ALTA, C43D, C48, C48-2, C48D, C48D-2, C48DDL, C48DL, C48E, C53, C53D, C6, C60, C60D, C6D, C81, CDN3, CDN4, CR43, CR43D, CR48, CR48D, DP35, DP35-2, DP35D, DP35D-2, DP40, DP40-2, DP40D, DP40D-2, DP40D-rib2, DP40-rib2, DP45, DP45D, DP50, DP50D, DP50D-115V, FW35, FW40, FW40B...(Other models you can see in the webshop)		



1

<b>GEV No.</b>	512368	<b>Ref. No.</b>	22121
<b>description</b>	door catch catch		
<b>For models:</b>	APS43, APS48, APS53, APS60, APSE43, APSE48, APSE53, APSE60, C3, C4, FW35, FW40, FW45, FW50		

## locks



1

<b>GEV No.</b>	511165	<b>Ref. No.</b>	331116 H331116
<b>description</b>	catch hook for door		
<b>For models:</b>	AC101, AC151, AC181, AC201, AC241, AC91, EDT100, EDT140, EDT170, EDT200, EDT230, EDT85, TR100, TR140, TR170, TR200, TR230, TR90, TR-E100, TR-E150, TR-E170, TR-E200, TR-E230, TR-E90		





1



<b>GEV No.</b>	510008	<b>Ref. No.</b>	33336
<b>description</b>	door catch for dishwasher		
<b>For models:</b>	60BT, 60BT-3, 60EBT, APS43, APS48, APS48B, APS53, APS60, APSE43, APSE48, APSE53, APSE60, C35, C35E, C43, C43-2, C43ALTA, C43D, C43DE, C43E, C46DE, C46E, C48, C48-2, C48D, C48D-2, C48DDL, C48DL, C48E, C53, C53D, C53DE, C53E, C6, C60, C60D, C60DE, C60E, C68DE, C68E, C68EBT, C6D, C6DE, C6E, C81, C81E, C81EBT, C90, C90DE, C90DE2...(Other models you can see in the webshop)		





Зип Общепит  
vsezip.ru  
+7(812)987-08-81

			
1			
<b>GEV No.</b>	692100	<b>Ref. No.</b>	180508 37198
<b>description</b>	snap lock L 36mm ø 17mm		
<b>For models:</b>	60EBT, C60DE, C60E, C6DE, C6E, C6EBT, SP50DE, SP50E		

<b>miscellaneous</b>			
			
1			
<b>GEV No.</b>	519411	<b>Ref. No.</b>	18069
<b>description</b>	bracket for door hinge		
<b>For models:</b>	APS43, APS48, APS48B, APS53, APS60, APSE43, APSE48, APSE53, APSE60, C3, C35, C4, C43, C43ALTA, C43D, C48, C48D, C48DDL, C48DL, C53, C53D, C60, C60D, CDN3, CDN4, CR43, CR43D, CR48, CR48D, DP35, DP35D, DP40, DP40D, DP45, DP45D, DP50, DP50D, FW35, FW40, FW40B, FW45, FW50, SP35, SP35ALTA, SP35D, SP40, SP40D, SP40DDL, SP40DL, SP45...(Other models you can see in the webshop)		

			
1			
<b>GEV No.</b>	512405	<b>Ref. No.</b>	190685
<b>description</b>	bush for door hinge plastic ø 10mm L 9mm		
<b>For models:</b>	AP43E, AP48E, AP53E, AP60E, DP45DE, DP45E, DP50DE, DP50E, DP50EBT, FW35E, FW40E, ST43DE, ST43E, ST48DE, ST48E, ST48EBT, ST53DE, ST53E, ST60DE, ST60E, ST60EBT		
<b>accessories for</b>	512405		
	<b>GEV No.</b>	501443	<b>Ref. No.</b> 324170
door hinge L 150mm HOONVED			

			
1			
<b>GEV No.</b>	512103	<b>Ref. No.</b>	31817
<b>description</b>	cam door catch		
<b>For models:</b>	BPN48, BPS43, BPS52, INDY43F, INDY48F, INDY53F, INDY60F, UNI43C, UNI43R, UNI43RD, UNI48C, UNI48CD, UNI48R, UNI48RD, UNI53C, UNI53R, UNI53RD, UNI60C		

			
1			
<b>GEV No.</b>	512104	<b>Ref. No.</b>	31956
<b>description</b>	cover for cam connection housing		
<b>For models:</b>	BPN48, INDY43F, INDY48F, INDY53F, INDY60F, UNI43C, UNI43R, UNI43RD, UNI48C, UNI48CD, UNI48R, UNI48RD, UNI53C, UNI53R, UNI53RD, UNI60C		

			
<b>GEV No.</b>	510938	<b>Ref. No.</b>	H331764
<b>description</b>	fixing plate for door seal fixing plate		
<b>For models:</b>	EDI13-2, EDI13ALTA-2, EDI4, EDI6-2, EDI8-2, LO134-2, LO134ALTA-2, LO56, LO67-2, LO83-2		

			
1			
<b>GEV No.</b>	524451	<b>Ref. No.</b>	35202
<b>description</b>	threaded bush for tie bar L 12mm D1 ø 9.6mm D2 ø 7.75mm		
<b>For models:</b>	C90, LO50, RLO50, US-X501		

<b>screw connections</b>			
			
1			
<b>GEV No.</b>	512313	<b>Ref. No.</b>	30436
<b>description</b>	nut		
<b>For models:</b>	E40-2F, INDY43F, INDY48F, INDY53F, INDY60F, TS43, TS48, UNI43C, UNI48C, UNI48CD, UNI53C, UNI60C		

			
1			
<b>GEV No.</b>	510457	<b>Ref. No.</b>	H160755
<b>description</b>	nut for stuff		
<b>For models:</b>	60EBT, C43DE, C43E, C46DE, C46E, C53DE, C53E, C60DE, C60E, C68DE, C68E, C6DE, C6E, SP35DE, SP35E, SP40DE, SP40E, SP45DE, SP45E, SP50DE, SP50E, SP50E-400V3-50Hz-MARINE, SP50E-440V3-60Hz-MARINE, SP5DE, SP5E, SP68DE, SP68E, ST53DE, ST53E, ST60DE, ST60E		

			
1			
<b>GEV No.</b>	512074	<b>Ref. No.</b>	26651
<b>description</b>	nut thread 1/2" H 7mm WS 27 plastic Qty 1 pcs		
<b>For models:</b>	ED600-95, ED630-90, ED650S, ED650S-90, ED700, ED700-90, ED900, ED900-90, EDI13, EDI13-2, EDI13ALTA, EDI13ALTA-2, EDI6, EDI6-2, EDI8, EDI8-2, K80F, K80G, LO122, LO134, LO134-2, LO134ALTA, LO134ALTA-2, LO60, LO67, LO67-2, LO78, LO83, LO83-2, RLO200, RLO300, RLO400, T3-80, T4-80, T5-80		

## Зип-Общепит

curtains

curtains

vsezip.ru

+7(812)987-08-81

1

<b>GEV No.</b>	510941	<b>Ref. No.</b>	190910 H190906
<b>description</b>	curtain W 620mm H 473mm N25		
<b>For models:</b>	EDT100, EDT140, EDT170, EDT200, EDT230, EDT85, TR100, TR140, TR170, TR200, TR230, TR90, TR-E100, TR-E150, TR-E170, TR-E200, TR-E230, TR-E90		

## curtain rods

1

<b>GEV No.</b>	533175	<b>Ref. No.</b>	340422 H340422
<b>description</b>	curtain rod L 660mm ø 8mm		
<b>For models:</b>	AC101, AC151, AC181, AC201, AC241, AC91, EDT100, EDT140, EDT170, EDT200, EDT230, EDT85, TR100, TR140, TR170, TR200, TR230, TR90, TR-E100, TR-E150, TR-E170, TR-E200, TR-E230, TR-E90		

## washing and rinsing systems

1

<b>GEV No.</b>	512233	<b>Ref. No.</b>	17922
<b>description</b>	blank thread 1/4" WS 24		
<b>For models:</b>	APS43, APS48, APS48B, APS53, APS60, APSE43, APSE48, APSE53, APSE60, FW35, FW40, FW40B, FW45, FW50		



1

<b>GEV No.</b>	511576	<b>Ref. No.</b>	160789
<b>description</b>	nut thread M10x1.5 H 5mm WS 19 plastic Qty 1 pcs		
<b>For models:</b>	CAP15EBT		



1

<b>GEV No.</b>	512382	<b>Ref. No.</b>	18463
<b>description</b>	screw connection for wash arm		



1

<b>GEV No.</b>	512177	<b>Ref. No.</b>	33476
<b>description</b>	screw connection thread 1/4" H 27mm Qty 1 pcs		
<b>For models:</b>	C98, CA120, CA55, CA90, CAP7, CAP7E, ED550, ED650E, ED650S, LO62, RCA1100, RCA1200, RCA1200i, SO55, SO55-400V3-50Hz-MARINE, SO55-440V3-60Hz-MARINE, SO55E		



1

<b>GEV No.</b>	512178	<b>Ref. No.</b>	33540
<b>description</b>	screw connection thread M16x1.25 H 31mm Qty 1 pcs		
<b>For models:</b>	C98, CA120, CA55, CA90, CAP7, CAP7E, ED550, ED650E, ED650S, LO62, RCA1100, RCA1200, RCA1200i, SO55, SO55-400V3-50Hz-MARINE, SO55-440V3-60Hz-MARINE, SO55E		





Зип Общепит  
vsezip.ru  
7(812)987-08-81



1

<b>GEV No.</b>	512240	<b>Ref. No.</b>	32282
<b>description</b>	bush for rinse arm		
<b>For models:</b>	APS43, APS48, APS48B, APS53, APSE43, APSE48, APSE53, FW35, FW40, FW40B, FW45		



1

<b>GEV No.</b>	512040	<b>Ref. No.</b>	25056
<b>description</b>	bush for wash arm		
<b>For models:</b>	ED630-90, ED650E, ED650E-90, ED650S, ED650S-90, ED700, ED900, T5-80		



1

<b>GEV No.</b>	512262	<b>Ref. No.</b>	H190641
<b>description</b>	bush for rinse arm		
<b>For models:</b>	C90DE2, C90E2, C90EBT2, C98, CA120, CA90, CAP10, CAP10BT, CAP12, CAP7, CAP7E, ED650E, ED650S, EDI13-2, EDI13ALTA-2, EDI13ALTABT, EDI13BT, EDI4, EDI6-2, EDI6BT, EDI8-2, EDI8BT, LO134-2, LO134ALTA-2, LO56, LO62, LO67-2, LO83-2, RCA1100, RCA1200, RCA1200i, SO100, SO100-400V3-50Hz-MARINE, SO100-440V3-60Hz-MARINE, SO120, SO55, SO55E		



1

<b>GEV No.</b>	512047	<b>Ref. No.</b>	30402
<b>description</b>	bush for wash arm		
<b>For models:</b>	DP35, DP35D, INDY43F, INDY48F, STS43, STS43D, TS48, UNI43C, UNI48C, UNI48CD		



1

<b>GEV No.</b>	511240	<b>Ref. No.</b>	35968
<b>description</b>	bush for wash arm		
<b>For models:</b>	C81, C81E, C81EBT, CA120, CA55, CA90, CAP10, CAP10BT, CAP10DE, CAP12, CAP12DE, CAP12EBT, CAP7, CAP7E, ED550, ED650E, ED650S, RCA1100, RCA1200, RCA1200i, SO100, SO100-400V3-50Hz-MARINE, SO100-440V3-60Hz-MARINE, SO120, SO55, SO55E, SP81, SP81E		



1

<b>GEV No.</b>	512050	<b>Ref. No.</b>	17972
<b>description</b>	bush for wash arm		
<b>For models:</b>	C53, C53D, C60, C60D, DP40, DP40D, DP45, DP45D, DP50, DP50D, INDY53F, INDY60F, SP45, SP45D, SP50, SP50-400V, SP50-440V, SP50D, STS48, STS48D, STS53, STS53D, STS60, STS60D, UNI53C, UNI60C		



1

<b>GEV No.</b>	511432	<b>Ref. No.</b>	33468
<b>description</b>	bush for wash arm		
<b>For models:</b>	C81, CA120, CA55, CA90, ED550, ED650E, ED650S, RCA1100, RCA1200, RCA1200i, SP81		



1

<b>GEV No.</b>	512053	<b>Ref. No.</b>	17971
<b>description</b>	bush for wash arm		
<b>For models:</b>	INDY43F, INDY48F, INDY53F, INDY60F, UNI43C, UNI48C, UNI48CD, UNI53C, UNI60C		



1

<b>GEV No.</b>	511434	<b>Ref. No.</b>	36188
<b>description</b>	bush for wash arm		
<b>For models:</b>	C81, C81E, C81EBT, CA120, CA55, CA90, CAP10, CAP10BT, CAP10DE, CAP12, CAP12DE, CAP12EBT, CAP7, CAP7E, ED550, ED650E, ED650S, RCA1100, SO100, SO100-400V3-50Hz-MARINE, SO100-440V3-60Hz-MARINE, SO120, SO55, SO55E, SP81, SP81E		



1

<b>GEV No.</b>	512062	<b>Ref. No.</b>	18703
<b>description</b>	bush for wash arm		
<b>For models:</b>	60BT, 60BT-3, C3, C4, C53, C53D, C60, C60D, DP35, DP35D, DP40, DP40D, DP45, DP45D, DP50, DP50D, DP50D-115V, GS-X1021, GS-X1021-WEH, RSP50, RSP50A, SD5BT, SP45, SP45D, SP50, SP50-400V, SP50-440V, SP50D, STS43, STS43D, STS48, STS48D, STS53, STS53D, STS60, STS60D, TN-TDN5, TN-TDN6, VS-X313, VS-X313-LP-DOS, VS-X515, VS-X515-LP-DOS		

Зип Общепит

vsezip.ru

+7(812)987-08-81

			
1			
<b>GEV No.</b>	512064	<b>Ref. No.</b>	32838
<b>description</b>	bush for wash arm		
<b>For models:</b>	60BT, 60BT-3, C53, C53D, C60, C60D, DP45, DP45D, DP50, DP50D, DP50D-115V, RSP50, RSP50A, SD5BT, SP45, SP45D, SP50, SP50-400V, SP50-440V, SP50D, STS43, STS43D, STS48, STS48D, STS53, STS53D, STS60, STS60D, TN-TDN5, TN-TDN6, VS-X313, VS-X313-LP-DOS, VS-X515, VS-X515-LP-DOS		

			
1			
<b>GEV No.</b>	511433	<b>Ref. No.</b>	36187
<b>description</b>	bush ø 23mm H 20mm		
<b>For models:</b>	C81, C81E, C81EBT, CA120, CA55, CA90, CAP10, CAP10BT, CAP10DE, CAP12, CAP12DE, CAP12EBT, CAP7, CAP7E, ED550, ED650E, ED650S, RCA1100, SO100, SO100-400V3-50Hz-MARINE, SO100-440V3-60Hz-MARINE, SO120, SO55, SO55E, SP81, SP81E		

			
1			
<b>GEV No.</b>	512275	<b>Ref. No.</b>	34262
<b>description</b>	bush for wash arm		
<b>For models:</b>	60BT, 60BT-3, C53, C53D, C60, C60D, DP35, DP35D, DP40, DP40D, DP45, DP45D, DP50, DP50D, DP50D-115V, GS-X1021, GS-X1021-WEH, RSP50, RSP50A, SD5BT, SP45, SP45D, SP50, SP50-400V, SP50-440V, SP50D, STS43, STS43D, STS48, STS48D, STS53, STS53D, STS60, STS60D, TN-TDN5, TN-TDN6, VS-X313, VS-X313-LP-DOS, VS-X515, VS-X515-LP-DOS		

			
1			
<b>GEV No.</b>	513318	<b>Ref. No.</b>	190697
<b>description</b>	bush ø 32mm H 28mm thread 3/4" ID ø 15.8mm Qty 1 pcs		
<b>For models:</b>	HT100, HT150, HTP195, HTP205, HTP220		

			
1			
<b>GEV No.</b>	512291	<b>Ref. No.</b>	25057
<b>description</b>	bush for wash arm		
<b>For models:</b>	K80F, M60, T3-80, T4-80, T6-80		

			
1			
<b>GEV No.</b>	512211	<b>Ref. No.</b>	34383
<b>description</b>	bushing for rinse arm		
<b>For models:</b>	60BT, 60BT-3, 60EBT, C35, C43, C43D, C48, C48D, C53, C53D, C53DE, C53E, C60, C60D, C60DE, C60E, C81, C81E, C90, C90DE, C90E, C90EBT, DP35, DP35-2, DP35D, DP35D-2, DP40, DP40-2, DP40D, DP40D-2, DP40D-rib2, DP40-rib2, DP45, DP45D, DP50, DP50D, DP50D-115V, EDI13, EDI13ALTA, EDI6, EDI8, GS-X1021, GS-X1021-2, GS-X1021-2rib, GS-X1021-WEH, GS-X1021-WEH-2, GS-X1021-WEH-2rib, LO134, LO134ALTA, LO50...(Other models you can see in the webshop)		

			
1			
<b>GEV No.</b>	512321	<b>Ref. No.</b>	35233
<b>description</b>	bush for wash arm		
<b>For models:</b>	DP35-2, DP35D-2, DP40-2, DP40D-2, DP40D-rib2, DP40-rib2, GS-X1021-2, GS-X1021-2rib, GS-X1021-WEH-2, GS-X1021-WEH-2rib, ST43DE, ST43E, ST48DE, ST48E, ST48EBT, STS43-2, STS43D-2, STS48-2, STS48D-2, STS48D-rib2, STS48-rib2, TDN4-2rib		

			
1			
<b>GEV No.</b>	519571	<b>Ref. No.</b>	H180406
<b>description</b>	connecting fitting for wash distributor L 220mm W 120mm H 60mm ED ø 51mm hole ø 42mm thickness 4.75mm		
<b>For models:</b>	EDT100, EDT140, EDT170, EDT200, EDT230, EDT85, TR100, TR140, TR170, TR200, TR230, TR90, TR-E100, TR-E150, TR-E170, TR-E200, TR-E230, TR-E90		
<b>accessories for</b>	519571		
	<b>GEV No.</b>	519462	<b>Ref. No.</b>
			200428 H200428
	gasket L 100mm W 100mm		
	<b>GEV No.</b>	520118	<b>Ref. No.</b>
			—
	hose clamp ø 50-70mm width 9mm Qty 5 pcs DIN 3017		

			
1			
<b>GEV No.</b>	512383	<b>Ref. No.</b>	31281
<b>description</b>	bush for wash arm		
<b>For models:</b>	INDY43F, INDY48F, INDY53F, INDY60F, TS43, TS48		





Зип Общепит  
vsezip.ru  
+7(812)987-08-81

			
1			
<b>GEV No.</b>	517796	<b>Ref. No.</b>	06785
<b>description</b>	connecting piece for rinse arm ID $\varnothing$ 7mm ED $\varnothing$ 10.7mm L 18mm		
<b>For models:</b>	APS43, APS48, APS48B, APS53, APS60, C3, C4, FW35, FW40, FW40B, FW45, FW50		

			
1			
<b>GEV No.</b>	512259	<b>Ref. No.</b>	30664
<b>description</b>	flange for wash arm support		
<b>For models:</b>	C53, C53D, C60, C60D, DP40, DP40D, DP45, DP45D, DP50, DP50D, E40-2F, INDY43F, INDY48F, INDY53F, INDY60F, SP45, SP45D, SP50, SP50-400V, SP50-440V, SP50D, STS48, STS48D, STS53, STS53D, STS60, STS60D, TS48, UNI43C, UNI48C, UNI48CD, UNI53C, UNI60C		

			
1			
<b>GEV No.</b>	512406	<b>Ref. No.</b>	30662
<b>description</b>	cover for washing arms ID $\varnothing$ 48mm ED $\varnothing$ 79mm thickness 8.5mm		
<b>For models:</b>	E40-2F, INDY43F, INDY48F, INDY53F, INDY60F, TS43, TS48		



			
1			
<b>GEV No.</b>	505399	<b>Ref. No.</b>	200977
<b>description</b>	gasket for wash arm $\varnothing$ 21mm ID $\varnothing$ 12mm thickness 5mm		

			
1			
<b>GEV No.</b>	517629	<b>Ref. No.</b>	25039
<b>description</b>	disc for rinse arm $\varnothing$ 12/18mm		
<b>For models:</b>	ED630-90, ED650E-90, ED650S-90, ED700, ED900		

			
1			
<b>GEV No.</b>	505314	<b>Ref. No.</b>	31063
<b>description</b>	gasket for wash arm thickness 1mm L 74.5mm W 42mm		
<b>For models:</b>	ED600-95, ED700-90, ED900-90, EDI5, LO122, LO60, LO61, LO78		

			
1			
<b>GEV No.</b>	517628	<b>Ref. No.</b>	25038
<b>description</b>	disc for rinse arm $\varnothing$ 16mm		
<b>For models:</b>	ED630-90, ED650E-90, ED650S-90, ED700, ED900		

			
1			
<b>GEV No.</b>	519462	<b>Ref. No.</b>	200428 H200428
<b>description</b>	gasket L 100mm W 100mm		

			
1			
<b>GEV No.</b>	507571	<b>Ref. No.</b>	180407 H180407
<b>description</b>	end piece for wash distributor L 170mm W 120mm H 60mm ED $\varnothing$ 51mm hole $\varnothing$ 41mm thickness 4.75mm suitable for COMENDA for ACxxx		
<b>For models:</b>	AC101, AC151, AC181, AC201, AC241, AC91, EDT100, EDT140, EDT170, EDT200, EDT230, EDT85, TR100, TR140, TR170, TR200, TR230, TR90, TR-E100, TR-E150, TR-E170, TR-E200, TR-E230, TR-E90		
<b>accessories for</b>	507571		
	<b>GEV No.</b>	519462	<b>Ref. No.</b>
			200428 H200428
	gasket L 100mm W 100mm		
	<b>GEV No.</b>	520118	<b>Ref. No.</b>
			—
	hose clamp $\varnothing$ 50-70mm width 9mm Qty 5 pcs DIN 3017		

			
1			
<b>GEV No.</b>	512061	<b>Ref. No.</b>	18691
<b>description</b>	hose connector thread 1/2"		
<b>For models:</b>	C3, C35, C4, C43, C43ALTA, C43D, C48, C48D, C48DDL, C48DL, SP35, SP35ALTA, SP35D, SP40, SP40D, SP40DDL, SP40DL, SPB35		



1

<b>GEV No.</b>	512245	<b>Ref. No.</b>	33544
<b>description</b>	hose connector thread 1/2" grommet ø 30mm ID ø 16mm grommet length 28mm total length 35mm ED ø 31.5mm		
<b>For models:</b>	60BT, 60BT-3, C43, C43ALTA, C48, C48D, C48DDL, C48DL, C53, C53D, C60, C60D, DP35, DP35D, DP40, DP40D, DP45, DP45D, DP50, DP50D, DP50D-115V, GS-X1021, GS-X1021-WEH, GS-X1021, GS-X1021-WEH, RSP50, RSP50A, SD5BT, SP35, SP35ALTA, SP40, SP40D, SP40DDL, SP40DL, SP45, SP45D, SP50, SP50-400V, SP50-440V, SP50D, STS43, STS43D, STS48, STS48D, STS53, STS53D, STS60, STS60D, TN-TDN5, TN-TDN6...(Other models you can see in the webshop)		



2

<b>GEV No.</b>	512085	<b>Ref. No.</b>	31165
<b>description</b>	impulse nozzle		



1

<b>GEV No.</b>	698577	<b>Ref. No.</b>	36006
<b>description</b>	knurled nut mounting pos. upper/lower thread M18 ø 35.3mm H 6mm SS		
<b>For models:</b>	C81E, C81EBT, C90, C90DE, C90DE2, C90E, C90E2, C90EBT, C90EBT2, C98, CA55, CA90, CAP10, CAP10BT, CAP10DE, CAP12, CAP12DE, CAP12EBT, CAP7, CAP7E, ED550, ED650E, ED650S, EDI13, EDI13-2, EDI13ALTA, EDI13ALTA-2, EDI13ALTABT, EDI13BT, EDI4, EDI6, EDI6-2, EDI6BT, EDI8, EDI8-2, EDI8BT, HD130BT, HD40ALTABT, HD40BT, HD60BT, HD80BT, LO134, LO134-2, LO134ALTA, LO134ALTA-2, LO50, LO50E, LO56, LO62, LO67...(Other models you can see in the webshop)		



1

<b>GEV No.</b>	512257	<b>Ref. No.</b>	34382
<b>description</b>	knurled nut thread M10L ø 30mm H 6.5mm SS		
<b>For models:</b>	60BT, 60BT-3, C35, C43, C43D, C48, C48D, C53, C53D, C60, C60D, C81, C90, DP35, DP35D, DP40, DP40D, DP45, DP45D, DP50, DP50D, DP50D-115V, GS-X1021, GS-X1021-WEH, LO50, RSP50, RSP50A, SD5BT, SP35, SP35D, SP40, SP40D, SP45, SP45D, SP50, SP50-400V, SP50-440V, SP50D, SP81, SPB35, STS43, STS43D, STS48, STS48D, STS53, STS53D, STS60, STS60D, TN-TDN5, TN-TDN6...(Other models you can see in the webshop)		

Зип Общепит

vsezip.ru

+7(812)987 08 81



1

<b>GEV No.</b>	512212	<b>Ref. No.</b>	34998
<b>description</b>	knurled nut thread M10x1.5 ø 30mm H 6.4mm SS		
<b>For models:</b>	60EBT, C53DE, C53E, C60DE, C60E, C81, C81E, C81EBT, C90, C90DE, C90E, C90EBT, DP35-2, DP35D-2, DP40-2, DP40D-2, DP40D-rib2, DP40-rib2, DP45DE, DP45E, DP50DE, DP50E, DP50EBT, EDI13, EDI13ALTA, EDI6, EDI8, GS-X1021-2, GS-X1021-2rib, GS-X1021-WEH-2, GS-X1021-WEH-2rib, LO134, LO134ALTA, LO50, LO50E, LO67, LO83, RLO200, RLO300, RLO400, RLO50, SMW15, SMW15E, SP45DE, SP45E, SP50DE, SP50E, SP50E-400V3-50Hz-MARINE, SP50E-440V3-60Hz-MARINE, SP81...(Other models you can see in the webshop)		



1

<b>GEV No.</b>	512038	<b>Ref. No.</b>	31659
<b>description</b>	manifold		
<b>For models:</b>	INDY48F, UNI48C, UNI48CD		



1

<b>GEV No.</b>	512042	<b>Ref. No.</b>	25055
<b>description</b>	nut		
<b>For models:</b>	ED630-90, ED650E, ED650E-90, ED650S, ED650S-90, ED700, ED900, K80F, M60, T3-80, T4-80, T5-80, T6-80		



1

<b>GEV No.</b>	512377	<b>Ref. No.</b>	27155
<b>description</b>	nut		
<b>For models:</b>	60BT, 60BT-3, 60EBT, AP43E, AP48E, AP53E, AP60E, APS43, APS48, APS48B, APS53, APS60, APSE43, APSE48, APSE53, APSE60, BPS43, C35, C35E, C43, C43-2, C43ALTA, C43D, C43DE, C43E, C46DE, C46E, C48, C48-2, C48D, C48D-2, C48DDL, C48DL, C48E, C53, C53D, C53DE, C53E, C6, C60, C60D, C60DE, C60E, C68DE, C68E, C68EBT, C6D, C6DE, C6E, C6EBT...(Other models you can see in the webshop)		





1



<b>GEV No.</b>	512244	<b>Ref. No.</b>	32359
<b>description</b>	nut for wash arm		
<b>For models:</b>	APS43, APS48, APS48B, APS53, APS60, APSE43, APSE48, APSE53, APSE60, C3, C4, C53, C53D, C60, C60D, DP35, DP35D, DP40, DP40D, DP45, DP45D, DP50, DP50D, FW35, FW40, FW40B, FW45, FW50, SP45, SP45D, SP50, SP50-400V, SP50-440V, SP50D, STS43, STS43D, STS48, STS48D, STS53, STS53D, STS60, STS60D		





Зип Общепит  
vsezip.ru  
+7(812)987-08-81

			
1			
<b>GEV No.</b>	512157	<b>Ref. No.</b>	15362
<b>description</b>	nut thread M12		
<b>For models:</b>	APS60, APSE60, ED650E, ED650S, FW50, K80F		

			
1			
<b>GEV No.</b>	512242	<b>Ref. No.</b>	17915
<b>description</b>	rinse pipe		
<b>For models:</b>	APS60, APSE60, FW50		

			
1			
<b>GEV No.</b>	518085	<b>Ref. No.</b>	180232 H180232
<b>description</b>	opposite support for wash arm mounting pos. upper/lower L 102mm W 102mm		
<b>accessories for</b>	518085		
	<b>GEV No.</b>	510899	<b>Ref. No.</b>
			200830 H200830
	O-ring EPDM thickness 3.53mm ID ø 37.69mm Qty 1 pcs		
	<b>GEV No.</b>	519462	<b>Ref. No.</b>
			200428 H200428
	gasket L 100mm W 100mm		

			
1			
<b>GEV No.</b>	512248	<b>Ref. No.</b>	17913
<b>description</b>	rinse pipe		
<b>For models:</b>	APS43, APS48, APS48B, APS53, APSE43, APSE48, APSE53, DP35, DP35D, DP40, DP40D, FW35, FW40, FW40B, FW45, STS43, STS43D, STS48, STS48D, STS60, STS60D		

			
1			
<b>GEV No.</b>	510801	<b>Ref. No.</b>	160113 H160113
<b>description</b>	pipe ID ø 8mm ø 12mm plastic supplied by meter		
<b>For models:</b>	AC101, AC151, AC181, AC201, AC241, AC91, EDT100, EDT140, EDT170, EDT200, EDT230, EDT85, HG2LR, HGLR, TR100, TR140, TR170, TR200, TR230, TR90, TR-E100, TR-E150, TR-E170, TR-E200, TR-E230		

			
1			
<b>GEV No.</b>	512250	<b>Ref. No.</b>	17938
<b>description</b>	rinse pipe		
<b>For models:</b>	APS60, APSE60, FW50		

			
1			
<b>GEV No.</b>	511668	<b>Ref. No.</b>	H190674
<b>description</b>	reducer for wash pipe ø 18mm		
<b>For models:</b>	CAP10, CAP10BT, CAP12, SO100, SO100-400V3-50Hz-MARINE, SO100-440V3-60Hz-MARINE, SO120		

			
1			
<b>GEV No.</b>	512279	<b>Ref. No.</b>	34396
<b>description</b>	rinse pipe		
<b>For models:</b>	DP35, DP35D, DP40, DP40D, GS-X1021, GS-X1021-WEH, STS43, STS43D, STS48, STS48D, STS60, STS60D		

			
1			
<b>GEV No.</b>	512068	<b>Ref. No.</b>	25036
<b>description</b>	rinse arm support mounting pos. upper		
<b>For models:</b>	APS43, APS48, APS48B, APS53, APS60, APSE43, APSE48, APSE53, APSE60, C3, C35, C4, C43, C43D, C48, C48D, C53, C53D, C60, C60D, DP35, DP35D, DP40, DP40D, DP45, DP45D, DP50, DP50D, E40-2F, FW35, FW40, FW40B, FW45, FW50, INDY43F, INDY48F, INDY53F, INDY60F, SP45, SP45D, SP50, SP50-400V, SP50-440V, SP50D, STS43, STS43D, STS48, STS48D, STS53, STS53D...(Other models you can see in the webshop)		

			
1			
<b>GEV No.</b>	512280	<b>Ref. No.</b>	34397
<b>description</b>	rinse pipe		
<b>For models:</b>	60BT, 60BT-3, C53, C53D, C60, C60D, DP45, DP45D, DP50, DP50D, DP50D-115V, RSP50, RSP50A, SD5BT, SP45, SP45D, SP50, SP50-400V, SP50-440V, SP50D, STS43, STS43D, STS53, STS53D, STS60, STS60D, TN-TDN5, TN-TDN6, VS-X313, VS-X313-LP-DOS, VS-X515, VS-X515-LP-DOS		

			
1			
<b>GEV No.</b>	512197	<b>Ref. No.</b>	33729
<b>description</b>	rinse pipe mounting pos. lower ø 10/12mm L 270mm		
<b>For models:</b>	CA120, CA55, CA90, CAP7, CAP7E, ED550, ED650E, ED650S, RCA1100, RCA1200, RCA1200i, SO55, SO55-400V3-50Hz-MARINE, SO55-440V3-60Hz-MARINE, SO55E		

Зип Общепит

vsezip.ru

8(812)987-08-81

			
1			
<b>GEV No.</b>	524514	<b>Ref. No.</b>	33473
<b>description</b>	rinse pipe mounting pos. upper ø 12mm L 265mm		
<b>For models:</b>	CA120, CA55, CA90, CAP7, CAP7E, ED550, ED650E, ED650S, ICA1100, RCA1200, RCA1200i, SO55, SO55-400V3-50Hz-MARINE, SO55-410V3-60Hz-MARINE, SO55E, TS43		

			
1			
<b>GEV No.</b>	512241	<b>Ref. No.</b>	17920
<b>description</b>	screw		
<b>For models:</b>	APS43, APS48, APS48B, APS53, APS60, APSE43, APSE48, APSE53, APSE60, FW35, FW40, FW40B, FW45, FW50		

			
1			
<b>GEV No.</b>	511185	<b>Ref. No.</b>	261005
<b>description</b>	screw for wash arm support mounting pos. upper		
<b>For models:</b>	60EBT, AC101, AC151, AC181, AC201, AC241, AC91, C53DE, C53E, C6, C60DE, C60E, C68DE, C68E, C68EBT, C6D, C6DE, C6E, C6EBT, DP45DE, DP45E, DP50DE, DP50E, DP50EBT, EDT100, EDT140, EDT170, EDT200, EDT230, EDT85, SP45DE, SP45E, SP50DE, SP50E, ST53DE, ST53E, ST60DE, ST60E, ST60EBT		

			
1			
<b>GEV No.</b>	512322	<b>Ref. No.</b>	32234 35234
<b>description</b>	screw connection		
<b>For models:</b>	C3, C4, DP35-2, DP35D-2, DP40-2, DP40D-2, DP40D-rib2, DP40-rib2, GS-X1021-2, GS-X1021-2rib, GS-X1021-WEH-2, GS-X1021-WEH-2rib, ST43DE, ST43E, ST48DE, ST48E, ST48EBT, STS43-2, STS43D-2, STS48-2, STS48D-2, STS48D-rib2, STS48-rib2, TDN4-2rib		

			
1			
<b>GEV No.</b>	512069	<b>Ref. No.</b>	17933
<b>description</b>	screw connection for wash pipe		
<b>For models:</b>	APS43, APS48, APS48B, APS53, APS60, APSE43, APSE48, APSE53, APSE60, C3, C35, C4, C43, C43D, C48, C48D, C53, C53D, C60, C60D, DP35, DP35D, DP40, DP40D, DP45, DP45D, DP50, DP50D, FW35, FW40, FW40B, FW45, FW50, INDY43F, INDY48F, INDY53F, INDY60F, SP45, SP45D, SP50, SP50-400V, SP50-440V, SP50D, STS43, STS43D, STS48, STS48D, STS53, STS53D, STS60...(Other models you can see in the webshop)		

			
1			
<b>GEV No.</b>	512508	<b>Ref. No.</b>	36213
<b>description</b>	spacer ring ø 22mm ID ø 14mm H 14mm		
<b>For models:</b>	APS43, APS48, APS48B, APS53, APS60, FW35, FW40, FW40B, FW45, FW50		

			
1			
<b>GEV No.</b>	512043	<b>Ref. No.</b>	16575
<b>description</b>	throttle disc		
<b>For models:</b>	ED630-90, ED650E, ED650E-90, ED650S, ED650S-90		

			
1			
<b>GEV No.</b>	512239	<b>Ref. No.</b>	32358
<b>description</b>	wash arm bearing		
<b>For models:</b>	APS43, APS48, APS48B, APS53, APS60, APSE43, APSE48, APSE53, APSE60, FW35, FW40, FW40B, FW45, FW50		

			
1			
<b>GEV No.</b>	512307	<b>Ref. No.</b>	30483 35959
<b>description</b>	wash arm bearing		
<b>For models:</b>	E40-2F, ED600-95, ED700-90, ED900-90, EDI13, EDI13ALTA, EDI5, EDI6, EDI8, INDY43F, INDY48F, INDY53F, INDY60F, LO122, LO134, LO134ALTA, LO60, LO61, LO67, LO78, LO83, RLO200, RLO300, RLO400, TS43, TS48		

			
1			
<b>GEV No.</b>	512046	<b>Ref. No.</b>	30557
<b>description</b>	wash jet mounting pos. upper H 38mm ø 97mm		
<b>For models:</b>	DP35, DP35D, INDY43F, INDY48F, STS43, STS43D, TS48, UNI43C, UNI48C, UNI48CD		



washing and rinsing systems (sorted by product)

HOONVED



1

<b>GEV No.</b>	512005	<b>Ref. No.</b>	17976
<b>description</b>	wash arm		
<b>For models:</b>	C53, C60, DP45, DP45D, DP50, DP50D, INDY53F, INDY60F, STS43, STS43D, STS53, STS53D, STS60, STS60D, UNI53C, UNI60C		



1

<b>GEV No.</b>	518597	<b>Ref. No.</b>	H420553
<b>description</b>	wash arm		
<b>For models:</b>	C81, C81E, CA120, CA55, CA90, CAP10, CAP10BT, CAP12, CAP7, CAP7E, ED550, ED650E, ED650S, RCA1100, SO100, SO100-400V3-50Hz-MARINE, SO100-440V3-60Hz-MARINE, SO120, SO55, SO55E, SP81, SP81E		

spare parts for

	<b>GEV No.</b>	509999	<b>Ref. No.</b>	—
	bush for rinse arm H 53mm ø 48.5mm SS			
	<b>GEV No.</b>	510236	<b>Ref. No.</b>	—
	plain washer ID ø 21mm ED ø 28mm thickness 1mm SS Qty 1 pcs			
	<b>GEV No.</b>	511241	<b>Ref. No.</b>	36011
	knurled nut thread M26x1 stainless steel ø 48.6mm H 10mm			



1

<b>GEV No.</b>	512300	<b>Ref. No.</b>	17974
<b>description</b>	wash arm L 385mm nozzles 7 mounting ø 22/49mm mounting pos. upper/lower		
<b>For models:</b>	C3, DP35, DP35D, DP40, DP40D, INDY43F, STS43, STS43D, STS48, STS48D, STS60, STS60D, UNI43C		

Зип Общепит

vsezip.ru

+7(812)987-08-81



<b>GEV No.</b>	512316	<b>Ref. No.</b>	35140
<b>description</b>	wash arm L 388mm nozzles 7 mounting ø 14/45.5mm mounting pos. lower		
<b>For models:</b>	DP35-2, DP35D-2, ST43DE, ST43E, STS43-2, STS43D-2		



1

<b>GEV No.</b>	512006	<b>Ref. No.</b>	17977
<b>description</b>	wash arm L 413mm nozzles 9 mounting ø 48.5mm mounting pos. lower		
<b>For models:</b>	INDY60F, UNI60C		



1

<b>GEV No.</b>	512004	<b>Ref. No.</b>	17975
<b>description</b>	wash arm L 415mm nozzles 9 mounting ø 32mm mounting pos. upper and bottom		
<b>For models:</b>	C4, C53, C53D, C60, C60D, DP40, DP40D, DP45, DP45D, GS-X1021, GS-X1021-WEH, INDY48F, INDY53F, SP45, SP45D, STS48, STS48D, STS53, STS53D, STS60, STS60D, UNI48C, UNI48CD, UNI53C		

accessories for

	<b>GEV No.</b>	512050	<b>Ref. No.</b>	17972
	bush for wash arm			
	<b>GEV No.</b>	512053	<b>Ref. No.</b>	17971
	bush for wash arm			
	<b>GEV No.</b>	512062	<b>Ref. No.</b>	18703
	bush for wash arm			
	<b>GEV No.</b>	512275	<b>Ref. No.</b>	34262
	bush for wash arm			

Зип Общепит

vsezip.ru

+7(812)987-08-81



1

<b>GEV No.</b>	512317	<b>Ref. No.</b>	35141
<b>description</b>	wash arm L 417mm nozzles 9 mounting ø 14/45.5mm mounting pos. lower		
<b>For models:</b>	DP40-2, DP40D-2, DP40D-rib2, DP40-rib2, GS-X1021-2, GS-X1021-2rib, GS-X1021-WEH-2, GS-X1021-WEH-2rib, ST48DE, ST48E, ST48EBT, STS48-2, STS48D-2, STS48D-rib2, STS48-rib2, TDN4-2rib		



1

<b>GEV No.</b>	512002	<b>Ref. No.</b>	17085
<b>description</b>	wash arm L 540mm nozzles 10 mounting ø 60mm mounting pos. upper/lower		
<b>For models:</b>	C81, CA120, CA55, CA90, ED550, ED630-90, ED650E, ED650E-90, ED650S, ED650S-90, RCA1100, RCA1200, RCA1200i, SP81		



1

<b>GEV No.</b>	512007	<b>Ref. No.</b>	33586
<b>description</b>	wash arm L 480mm nozzles 8 mounting ø 48mm mounting pos. lower		
<b>For models:</b>	60BT, 60BT-3, C53, C53D, C60, C60D, DP45, DP45D, DP50, DP50D, DP50D-115V, RSP50, RSP50A, SD5BT, SP45, SP45D, SP50, SP50-400V, SP50-440V, SP50D, STS43, STS43D, STS48, STS48D, STS53, STS53D, STS60, STS60D, TN-TDN5, TN-TDN6, VS-X313, VS-X313-LP-DOS, VS-X515, VS-X515-LP-DOS		



1

<b>GEV No.</b>	512299	<b>Ref. No.</b>	21060
<b>description</b>	wash arm mounting pos. lower		
<b>For models:</b>	INDY53F		



1

<b>GEV No.</b>	510259	<b>Ref. No.</b>	H20548 H420548
<b>description</b>	wash arm L 505mm mounting pos. upper/lower nozzles 8 mounting ø 12/41mm		
<b>For models:</b>	60EBT, C53DE, C53E, C60DE, C60E, SP45DE, SP45E, SP50DE, SP50E, SP50E-400V3-50Hz-MARINE, SP50E-440V3-60Hz-MARINE, ST53DE, ST53E, ST60DE, ST60E		

spare parts for 510259



<b>GEV No.</b>	510313	<b>Ref. No.</b>	190617 H190617
<b>description</b>	bush H 12mm D1 ø 20mm D2 ø 16mm D3 ø 12mm for wash arm boss		



<b>GEV No.</b>	511007	<b>Ref. No.</b>	H191070
<b>description</b>	bush for wash arm support		



<b>GEV No.</b>	511231	<b>Ref. No.</b>	H191069
<b>description</b>	wash arm bearing		



1

<b>GEV No.</b>	511007	<b>Ref. No.</b>	H191070
<b>description</b>	bush for wash arm support		
<b>For models:</b>	60EBT, C53DE, C53E, C60DE, C60E, SP45DE, SP45E, SP50DE, SP50E, SP50E-400V3-50Hz-MARINE, SP50E-440V3-60Hz-MARINE, ST53DE, ST53E, ST60DE, ST60E		



1

<b>GEV No.</b>	510313	<b>Ref. No.</b>	190617 H190617
<b>description</b>	bush H 12mm D1 ø 20mm D2 ø 16mm D3 ø 12mm for wash arm boss		
<b>For models:</b>	60EBT, C53DE, C53E, C60DE, C60E, C68DE, C68E, CA120, CA55, CA90, DP45DE, DP45E, DP50DE, DP50E, DP50EBT, ED550, ED650E, ED650S, RCA1100, RCA1200, RCA1200i, SP45DE, SP45E, SP50DE, SP50E, SP50E-400V3-50Hz-MARINE, SP50E-440V3-60Hz-MARINE, SP68DE, SP68E, ST53DE, ST53E, ST60DE, ST60E, ST60EBT		















Зип Общепит

vsezip.ru

+7(812)987-08-81

			
1			
<b>GEV No.</b>	512314	<b>Ref. No.</b>	35081
<b>description</b>	rinse arm L 340mm mounting ø 16mm nozzles 4		
<b>For models:</b>	DP35-2, DP35D-2, ST43DE, ST43E, STS43-2, STS43D-2		
<b>spare parts for</b>	512314		
	<b>GEV No.</b>	511237	<b>Ref. No.</b> 34360
	O-ring EPDM thickness 1mm ID ø 7mm Qty 1 pcs		
	<b>GEV No.</b>	511238	<b>Ref. No.</b> 34293
	opposite support for rinse jet		
	<b>GEV No.</b>	512210	<b>Ref. No.</b> 34997
	rinse arm shaft		
	<b>GEV No.</b>	512211	<b>Ref. No.</b> 34383
	bushing for rinse arm		
	<b>GEV No.</b>	512232	<b>Ref. No.</b> 34264
	rinse jet		





			
1			
<b>GEV No.</b>	512252	<b>Ref. No.</b>	34395 34395/R
<b>description</b>	rinse arm L 350mm mounting ø 16mm nozzles 4 mounting pos. upper		
<b>For models:</b>	C35, C43, C43D, C48, C48D, SP35, SP35D, SP40, SP40D		
<b>spare parts for</b>	512252		
	<b>GEV No.</b>	511237	<b>Ref. No.</b> 34360
	O-ring EPDM thickness 1mm ID ø 7mm Qty 1 pcs		
	<b>GEV No.</b>	511238	<b>Ref. No.</b> 34293
	opposite support for rinse jet		
	<b>GEV No.</b>	512211	<b>Ref. No.</b> 34383
	bushing for rinse arm		
	<b>GEV No.</b>	512232	<b>Ref. No.</b> 34264
	rinse jet		

			
1			
<b>GEV No.</b>	512270	<b>Ref. No.</b>	34385
<b>description</b>	rinse arm L 340mm mounting ø 16mm nozzles 42 mounting pos. lower		
<b>For models:</b>	C35, C43, C43D, C48, C48D, DP35, DP35D, SP35, SP35D, SP40, SP40D, SPB35, STS43, STS43D		
<b>spare parts for</b>	512270		
	<b>GEV No.</b>	511237	<b>Ref. No.</b> 34360
	O-ring EPDM thickness 1mm ID ø 7mm Qty 1 pcs		
	<b>GEV No.</b>	511238	<b>Ref. No.</b> 34293
	opposite support for rinse jet		
	<b>GEV No.</b>	512211	<b>Ref. No.</b> 34383
	bushing for rinse arm		
	<b>GEV No.</b>	512232	<b>Ref. No.</b> 34264
	rinse jet		
	<b>GEV No.</b>	512257	<b>Ref. No.</b> 34382
	knurled nut thread M10L ø 30mm H 6.5mm SS		

			
1			
<b>GEV No.</b>	512202	<b>Ref. No.</b>	36245
<b>description</b>	rinse arm L 415mm mounting ø 12mm nozzles 5 mounting pos. upper		





			
1			
<b>GEV No.</b>	512271	<b>Ref. No.</b>	34386
<b>description</b>	rinse arm L 417mm mounting ø 16mm nozzles 5 mounting pos. upper		
<b>For models:</b>	DP40, DP40D, DP45, DP45D, DP50, DP50D, GS-X1021, GS-X1021-WEH, STS48, STS48D, STS53, STS53D, STS60, STS60D		
<b>spare parts for</b>	512271		
	<b>GEV No.</b>	511237	<b>Ref. No.</b> 34360
	O-ring EPDM thickness 1mm ID ø 7mm Qty 1 pcs		
	<b>GEV No.</b>	511238	<b>Ref. No.</b> 34293
	opposite support for rinse jet		

Table continues overleaf

spare parts for		512271		
	GEV No.	512018	Ref. No.	34384
	rinse arm shaft mounting pos. upper/lower $\varnothing$ 16mm thread M10L L 38mm			
	GEV No.	512211	Ref. No.	34383
	bushing for rinse arm			
	GEV No.	512232	Ref. No.	34264
	rinse jet			
	GEV No.	512257	Ref. No.	34382
	knurled nut thread M10L $\varnothing$ 30mm H 6.5mm SS			



1

GEV No.	512315	Ref. No.	35082	
<b>description</b>	rinse arm L 418mm mounting $\varnothing$ 16mm nozzles 5 mounting pos. upper/lower			
<b>For models:</b>	DP40-2, DP40D-2, DP40D-rib2, DP40-rib2, GS-X1021-2, GS-X1021-2rib, GS-X1021-WEH-2, GS-X1021-WEH-2rib, ST48DE, ST48E, ST48EBT, STS48-2, STS48D-2, STS48D-rib2, STS48-rib2, TDN4-2rib			
spare parts for		512315		
	GEV No.	511237	Ref. No.	34360
	O-ring EPDM thickness 1mm ID $\varnothing$ 7mm Qty 1 pcs			
	GEV No.	511238	Ref. No.	34293
	opposite support for rinse jet			
	GEV No.	512210	Ref. No.	34997
	rinse arm shaft			
	GEV No.	512211	Ref. No.	34383
	bushing for rinse arm			
	GEV No.	512232	Ref. No.	34264
	rinse jet			







1

GEV No.	512272	Ref. No.	34387	
<b>description</b>	rinse arm L 484mm mounting $\varnothing$ 16mm nozzles 6 mounting pos. upper/lower			
<b>For models:</b>	60BT, 60BT-3, C53, C53D, C60, C60D, DP45, DP45D, DP50, DP50D, DP50D-115V, RSP50, RSP50A, SD5BT, SP45, SP45D, SP50, SP50-400V, SP50-440V, SP50D, STS53, STS53D, STS60, STS60D, TN-TDN5, TN-TDN6, VS-X313, VS-X313-LP-DOS, VS-X515, VS-X515-LP-DOS			
spare parts for		512272		
	GEV No.	511237	Ref. No.	34360
	O-ring EPDM thickness 1mm ID $\varnothing$ 7mm Qty 1 pcs			

Зип-Общепит







vsezip.ru

+7(812)987-08-81

spare parts for		512272		
	GEV No.	511238	Ref. No.	34293
	opposite support for rinse jet			
	GEV No.	512018	Ref. No.	34384
	rinse arm shaft mounting pos. upper/lower $\varnothing$ 16mm thread M10L L 38mm			
	GEV No.	512211	Ref. No.	34383
	bushing for rinse arm			
	GEV No.	512232	Ref. No.	34264
	rinse jet			
	GEV No.	512257	Ref. No.	34382
	knurled nut thread M10L $\varnothing$ 30mm H 6.5mm SS			











1

GEV No.	512188	Ref. No.	430344 H430344	
<b>description</b>	rinse arm L 500mm mounting $\varnothing$ 16mm nozzles 6 mounting pos. upper/lower stainless steel			
<b>For models:</b>	CAP10, CAP10BT, CAP10DE, CAP7, CAP7E, SO100, SO100-400V3-50Hz-MARINE, SO100-440V3-60Hz-MARINE, SO55, SO55E			
spare parts for		512188		
	GEV No.	510307	Ref. No.	261009 H261009
	Thumb screw thread M6 H 3mm thread L 8mm $\varnothing$ 28mm SS			
	GEV No.	511237	Ref. No.	34360
	O-ring EPDM thickness 1mm ID $\varnothing$ 7mm Qty 1 pcs			
	GEV No.	511238	Ref. No.	34293
	opposite support for rinse jet			
	GEV No.	511242	Ref. No.	H450218
	connector holder L 30mm H 16mm W 22mm			
	GEV No.	512232	Ref. No.	34264
	rinse jet			
	GEV No.	512262	Ref. No.	H190641
	bush for rinse arm			











Зип-Общепит  
vsezip.ru  
+7(812)987-08-81

			
1			
<b>GEV No.</b>	512479	<b>Ref. No.</b>	36409 36410
<b>description</b>	rinse arm L 500mm mounting pos. upper/lower nozzles 6 for model C53/60 E		
<b>For models:</b>	60EBT, C53DE, C53E, C60DE, C60E, DP45DE, DP45E, DP50DE, DP50E, DP50EBT, SP45DE, SP45E, SP50DE, SP50E, SP50E-400V3-50Hz-MARINE, SP50E-440V3-60Hz-MARINE, ST53DE, ST53E, ST60DE, ST60E, ST60EBT		
<b>accessories for</b>	512479		
	<b>GEV No.</b>	511237	<b>Ref. No.</b> 34360
	O-ring EPDM thickness 1mm ID ø 7mm Qty 1 pcs		
	<b>GEV No.</b>	511238	<b>Ref. No.</b> 34293
	opposite support for rinse jet		
	<b>GEV No.</b>	512211	<b>Ref. No.</b> 34383
	bushing for rinse arm		
	<b>GEV No.</b>	512212	<b>Ref. No.</b> 34998
	knurled nut thread M10x1.5 ø 30mm H 6.4mm SS		
	<b>GEV No.</b>	512232	<b>Ref. No.</b> 34264
	rinse jet		

<b>spare parts for</b> 512209			
	<b>GEV No.</b>	512212	<b>Ref. No.</b> 34998
	knurled nut thread M10x1.5 ø 30mm H 6.4mm SS		
	<b>GEV No.</b>	560140	<b>Ref. No.</b> 30194
	hexagonal nut thread M4 H 4.8mm SS WS 7 Qty 20 pcs DIN/ISO DIN 985 self-locking		

			
1			
<b>GEV No.</b>	512186	<b>Ref. No.</b>	36237
<b>description</b>	wash arm L 335mm nozzles 4 mounting ø 15/26mm mounting pos. lower		

			
1			
<b>GEV No.</b>	512187	<b>Ref. No.</b>	36238
<b>description</b>	wash arm mounting pos. lower L 393mm nozzles 5 stainless steel		

			
1			
<b>GEV No.</b>	512209	<b>Ref. No.</b>	35404
<b>description</b>	rinse arm L 530mm mounting pos. upper/lower nozzles 6 mounting ø 16mm		
<b>spare parts for</b>	512209		
	<b>GEV No.</b>	510303	<b>Ref. No.</b> 31014 456030 H200818
	O-ring EPDM thickness 1.78mm ID ø 6.75mm Qty 1 pcs		
	<b>GEV No.</b>	510309	<b>Ref. No.</b> 170911 H170911
	nozzle for rinse arm mounting pos. right/left		
	<b>GEV No.</b>	510310	<b>Ref. No.</b> 170704 H170704
	opposite support for rinse jet		
	<b>GEV No.</b>	511004	<b>Ref. No.</b> H260226
	flat-headed bolt thread M4 thread L 12mm SS DIN 84/ISO 1207 Qty 1 pcs intake slotted L 14.5mm		
	<b>GEV No.</b>	512210	<b>Ref. No.</b> 34997
	rinse arm shaft		
	<b>GEV No.</b>	512211	<b>Ref. No.</b> 34383
	bushing for rinse arm		

			
1			
<b>GEV No.</b>	511242	<b>Ref. No.</b>	H450218
<b>description</b>	connector holder L 30mm H 16mm W 22mm		
<b>For models:</b>	C90DE2, C90E2, C90EBT2, C98, CA120, CA90, CAP10, CAP10BT, CAP12, CAP7, CAP7E, ED650E, ED650S, EDI13-2, EDI13ALTA-2, EDI13ALTABT, EDI13BT, EDI4, EDI6-2, EDI6BT, EDI8-2, EDI8BT, LO134-2, LO134ALTA-2, LO56, LO62, LO67-2, LO83-2, RCA1100, RCA1200, RCA1200i, SO100, SO100-400V3-50Hz-MARINE, SO100-440V3-60Hz-MARINE, SO120, SO55, SO55E		

			
1			
<b>GEV No.</b>	511238	<b>Ref. No.</b>	34293
<b>description</b>	opposite support for rinse jet		



			
1			
<b>GEV No.</b>	512320	<b>Ref. No.</b>	34293
<b>description</b>	opposite support for rinse jet		
<b>For models:</b>	60BT, 60BT-3, 60EBT, AP43E, AP48E, AP53E, AP60E, APS43, APS48, APS48B, APS53, APS60, C35, C43, C43D, C48, C48D, C53, C53D, C53DE, C53E, C60, C60D, C60DE, C60E, C68DE, C68E, C68EBT, C81, C90, CAP10, CAP10BT, CAP10DE, CAP7, CAP7E, DP35, DP35-2, DP35D, DP35D-2, DP40, DP40-2, DP40D, DP40D-2, DP40D-rib2, DP40-rib2, DP45, DP45D, DP45DE, DP45E, DP50...(Other models you can see in the webshop)		



1				
<b>GEV No.</b>	511237	<b>Ref. No.</b>	34360	
<b>description</b>	O-ring EPDM thickness 1mm ID ø 7mm Qty 1 pcs			
<b>For models:</b>	60BT, 60BT-3, 60EBT, AP43E, AP48E, AP53E, AP60E, APS43, APS48, APS48B, APS53, APS60, C35, C43, C43D, C48, C48D, C53, C53D, C53DE, C53E, C60, C60D, C60DE, C60E, C68DE, C68E, C68EBT, C81, C90, CAP10, CAP10BT, CAP10DE, CAP7, CAP7E, DP35, DP35-2, DP35D, DP35D-2, DP40, DP40-2, DP40D, DP40D-2, DP40D-rib2, DP40-rib2, DP45, DP45D, DP45DE, DP45E, DP50...(Other models you can see in the webshop)			

1				
<b>GEV No.</b>	512232	<b>Ref. No.</b>	34264	
<b>description</b>	rinse jet			
<b>For models:</b>	60BT, 60BT-3, 60EBT, AP43E, AP48E, AP53E, AP60E, APS43, APS48, APS48B, APS53, APS60, C35, C43, C43D, C48, C48D, C53, C53D, C53DE, C53E, C60, C60D, C60DE, C60E, C68DE, C68E, C68EBT, C81, C90, CAP10, CAP10BT, CAP10DE, CAP7, CAP7E, DP35, DP35-2, DP35D, DP35D-2, DP40, DP40-2, DP40D, DP40D-2, DP40D-rib2, DP40-rib2, DP45, DP45D, DP45DE, DP45E, DP50...(Other models you can see in the webshop)			

1				
<b>GEV No.</b>	510307	<b>Ref. No.</b>	261009 H261009	
<b>description</b>	Thumb screw thread M6 H 3mm thread L 8mm ø 28mm SS			
<b>For models:</b>	C35, C35E, C43, C43-2, C43ALTA, C43D, C43DE, C43E, C46DE, C46E, C48, C48-2, C48D, C48D-2, C48DDL, C48DL, C48E, C6, C68DE, C68E, C68EBT, C6D, C6DE, C6E, C6EBT, C90DE2, C90E2, C90EBT2, C98, CA120, CA55, CA90, CAP10, CAP10BT, CAP10DE, CAP12, CAP12DE, CAP12EBT, CAP15EBT, CAP7, CAP7E, ED550, ED650E, ED650S, EDI13-2, EDI13ALTA-2, EDI13ALTABT, EDI13BT, EDI4, EDI6-2...(Other models you can see in the webshop)			

1				
<b>GEV No.</b>	517625	<b>Ref. No.</b>	34263	
<b>description</b>	wash jet H 16mm ø 12mm			
<b>For models:</b>	APS43, APS48, APS48B, APS53, APS60, FW35, FW40, FW40B, FW45, FW50			

1				
<b>GEV No.</b>	512325	<b>Ref. No.</b>	33892 430316	
<b>description</b>	rinse arm L 490mm mounting ø 12mm nozzles 6 mounting pos. upper/lower			
<b>For models:</b>	CA120, CAP12, CAP12DE, CAP12EBT, CAP15EBT, ED650E, ED650S, RCA1100, RCA1200, RCA1200i, SO120			
<b>spare parts for</b>	512325			
	<b>GEV No.</b>	510307	<b>Ref. No.</b>	261009 H261009
		Thumb screw thread M6 H 3mm thread L 8mm ø 28mm SS		

<b>spare parts for</b>	512325			
	<b>GEV No.</b>	510369	<b>Ref. No.</b>	H380314
		nozzle for rinse arm		
	<b>GEV No.</b>	511242	<b>Ref. No.</b>	H450218
		connector holder L 30mm H 16mm W 22mm		
	<b>GEV No.</b>	512262	<b>Ref. No.</b>	H190641
		bush for rinse arm		

1				
<b>GEV No.</b>	511242	<b>Ref. No.</b>	H450218	
<b>description</b>	connector holder L 30mm H 16mm W 22mm			
<b>For models:</b>	C90DE2, C90E2, C90EBT2, C98, CA120, CA90, CAP10, CAP10BT, CAP12, CAP7, CAP7E, ED650E, ED650S, EDI13-2, EDI13ALTA-2, EDI13ALTABT, EDI13BT, EDI4, EDI6-2, EDI6BT, EDI8-2, EDI8BT, LO134-2, LO134ALTA-2, LO56, LO62, LO67-2, LO83-2, RCA1100, RCA1200, RCA1200i, SO100, SO100-400V3-50Hz-MARINE, SO100-440V3-60Hz-MARINE, SO120, SO55, SO55E			

1				
<b>GEV No.</b>	510369	<b>Ref. No.</b>	H380314	
<b>description</b>	nozzle for rinse arm			
<b>For models:</b>	CA120, CA90, CAP12, ED650E, ED650S, RCA1100, RCA1200, RCA1200i, SO120			

1				
<b>GEV No.</b>	510307	<b>Ref. No.</b>	261009 H261009	
<b>description</b>	Thumb screw thread M6 H 3mm thread L 8mm ø 28mm SS			
<b>For models:</b>	C35, C35E, C43, C43-2, C43ALTA, C43D, C43DE, C43E, C46DE, C46E, C48, C48-2, C48D, C48D-2, C48DDL, C48DL, C48E, C6, C68DE, C68E, C68EBT, C6D, C6DE, C6E, C6EBT, C90DE2, C90E2, C90EBT2, C98, CA120, CA55, CA90, CAP10, CAP10BT, CAP10DE, CAP12, CAP12DE, CAP12EBT, CAP15EBT, CAP7, CAP7E, ED550, ED650E, ED650S, EDI13-2, EDI13ALTA-2, EDI13ALTABT, EDI13BT, EDI4, EDI6-2...(Other models you can see in the webshop)			



1				
<b>GEV No.</b>	512008	<b>Ref. No.</b>	33957	
<b>description</b>	wash and rinse arm 2 wash arms/ 2 rinse arms			
<b>For models:</b>	C35, C43, C43ALTA, C43D, C48, C48D, C48DDL, C48DL, GS-X1011, GS-X1011-WEH, SP35, SP35ALTA, SP35D, SP40, SP40D, SP40DDL, SP40DL, SPB35			
<b>spare parts for</b>	512008			
	<b>GEV No.</b>	510307	<b>Ref. No.</b>	261009 H261009
		Thumb screw thread M6 H 3mm thread L 8mm ø 28mm SS		
	<b>GEV No.</b>	510321	<b>Ref. No.</b>	160736 H160736
		end cap for wash arm		

Table continues overleaf







spare parts for		512008	
	GEV No.	510322	Ref. No. 27050
O-ring EPDM thickness 1.78mm ID ø 17.17mm Qty 1 pcs			
	GEV No.	510323	Ref. No. 160734 33793
end cap for rinse arm			
	GEV No.	510325	Ref. No. 170956 H170956
nozzle for wash arm			
	GEV No.	510327	Ref. No. 170946 33791 H170946
nozzle for rinse arm			
	GEV No.	510329	Ref. No. 190624 190649 H190624 H190649
bush H 13.5mm D1 ø 20mm D2 ø 16mm D3 ø 12mm for wash arm			
	GEV No.	510901	Ref. No. H200843
O-ring EPDM thickness 2mm ID ø 13mm Qty 1 pcs			
	GEV No.	510902	Ref. No. 33790
O-ring EPDM thickness 2mm ID ø 9.5mm Qty 1 pcs			
	GEV No.	512265	Ref. No. 140106 H140108
connector holder			
	GEV No.	528583	Ref. No. 33792
O-ring EPDM thickness 2.62mm ID ø 9.13mm Qty 1 pcs			

1			
<b>GEV No.</b>	512264	<b>Ref. No.</b>	H420531
<b>description</b>	wash and rinse arm wash arm L 410mm rinse arm L 410mm mounting pos. lower w. jets 6 r. jets 4 mounting ø 12/45mm 2 wash arms/ 2 rinse arms		
<b>For models:</b>	C35, C35E, C43-2, C43DE, C43E, C46DE, C46E, C48-2, C48D-2, C48E, GS-X1011-2, GS-X1011-WEH-2, RSP40, RSP40A, SP35-2, SP35DE, SP35E, SP40-2, SP40D-2, SP40DE, SP40E, SPB35, SPB35E		
<b>spare parts for</b>	512264		
	GEV No.	510307	Ref. No. 261009 H261009
Thumb screw thread M6 H 3mm thread L 8mm ø 28mm SS			
	GEV No.	510321	Ref. No. 160736 H160736
end cap for wash arm			
	GEV No.	510322	Ref. No. 27050
O-ring EPDM thickness 1.78mm ID ø 17.17mm Qty 1 pcs			
	GEV No.	510323	Ref. No. 160734 33793
end cap for rinse arm			
	GEV No.	510325	Ref. No. 170956 H170956
nozzle for wash arm			
	GEV No.	510327	Ref. No. 170946 33791 H170946
nozzle for rinse arm			
	GEV No.	510329	Ref. No. 190624 190649 H190624 H190649
bush H 13.5mm D1 ø 20mm D2 ø 16mm D3 ø 12mm for wash arm			

spare parts for		512264	
	GEV No.	510327	Ref. No. 170946 33791 H170946
nozzle for rinse arm			
	GEV No.	510325	Ref. No. 190624 190649 H190624 H190649
bush H 13.5mm D1 ø 20mm D2 ø 16mm D3 ø 12mm for wash arm			
	GEV No.	510901	Ref. No. H200843
O-ring EPDM thickness 2mm ID ø 13mm Qty 1 pcs			
	GEV No.	510902	Ref. No. 33790
O-ring EPDM thickness 2mm ID ø 9.5mm Qty 1 pcs			
	GEV No.	512265	Ref. No. 140106 H140108
connector holder			
	GEV No.	528583	Ref. No. 33792
O-ring EPDM thickness 2.62mm ID ø 9.13mm Qty 1 pcs			

1			
<b>GEV No.</b>	512385	<b>Ref. No.</b>	33968 H420551
<b>description</b>	wash and rinse arm wash arm L 410mm rinse arm L 410mm mounting pos. upper w. jets 6 r. jets 4 mounting ø 12/45mm		
<b>For models:</b>	C35E, C43-2, C43ALTA, C43DE, C43E, C46DE, C46E, C48-2, C48D-2, C48DDL, C48DL, C48E, GS-X1011, GS-X1011-2, GS-X1011-WEH, GS-X1011-WEH-2, RSP40, RSP40A, SP35-2, SP35ALTA, SP35DE, SP35E, SP40-2, SP40D-2, SP40DDL, SP40DE, SP40DL, SP40E, SPB35E		
<b>spare parts for</b>	512385		
	GEV No.	510307	Ref. No. 261009 H261009
Thumb screw thread M6 H 3mm thread L 8mm ø 28mm SS			
	GEV No.	510322	Ref. No. 27050
O-ring EPDM thickness 1.78mm ID ø 17.17mm Qty 1 pcs			
	GEV No.	510323	Ref. No. 160734 33793
end cap for rinse arm			
	GEV No.	510325	Ref. No. 170956 H170956
nozzle for wash arm			
	GEV No.	510327	Ref. No. 170946 33791 H170946
nozzle for rinse arm			
	GEV No.	510329	Ref. No. 190624 190649 H190624 H190649
bush H 13.5mm D1 ø 20mm D2 ø 16mm D3 ø 12mm for wash arm			

Table continues overleaf

spare parts for		512385	
	GEV No.	510901	Ref. No. H200843
O-ring EPDM thickness 2mm ID ø 13mm Qty 1 pcs			
	GEV No.	510902	Ref. No. 33790
O-ring EPDM thickness 2mm ID ø 9.5mm Qty 1 pcs			
	GEV No.	512265	Ref. No. 140106 H140108
connector holder			
	GEV No.	528583	Ref. No. 33792
O-ring EPDM thickness 2.62mm ID ø 9.13mm Qty 1 pcs			



1			
<b>GEV No.</b>	510275	<b>Ref. No.</b>	420526 H420526
<b>description</b>	wash and rinse arm wash arm L 505mm rinse arm L 505mm mounting pos. upper/lower w. jets 8 r. jets 5 mounting ø 12/45mm		
<b>For models:</b>	C6, C6D, C6DE, C6E, C6EBT, SP5, SP5D, SP5DE, SP5E		

spare parts for		510275	
	GEV No.	510307	Ref. No. 261009 H261009
Thumb screw thread M6 H 3mm thread L 8mm ø 28mm SS			
	GEV No.	510321	Ref. No. 160736 H160736
end cap for wash arm			
	GEV No.	510322	Ref. No. 27050
O-ring EPDM thickness 1.78mm ID ø 17.17mm Qty 1 pcs			
	GEV No.	510323	Ref. No. 160734 33793
end cap for rinse arm			
	GEV No.	510325	Ref. No. 170956 H170956
nozzle for wash arm			
	GEV No.	510327	Ref. No. 170946 33791 H170946
nozzle for rinse arm			
	GEV No.	510329	Ref. No. 190624 190649 H190624 H190649
bush H 13.5mm D1 ø 20mm D2 ø 16mm D3 ø 12mm for wash arm			
	GEV No.	510902	Ref. No. 33790
O-ring EPDM thickness 2mm ID ø 9.5mm Qty 1 pcs			
	GEV No.	512265	Ref. No. 140106 H140108
connector holder			
	GEV No.	528583	Ref. No. 33792
O-ring EPDM thickness 2.62mm ID ø 9.13mm Qty 1 pcs			

Зип Общепит

vsezip.ru

+7(812)987-08-81



1			
<b>GEV No.</b>	510329	<b>Ref. No.</b>	190624 190649 H190624 H190649
<b>description</b>	bush H 13.5mm D1 ø 20mm D2 ø 16mm D3 ø 12mm for wash arm		
<b>For models:</b>	C35, C35E, C43, C43-2, C43ALTA, C43D, C43DE, C43E, C46DE, C46E, C48, C48-2, C48D, C48D-2, C48DDL, C48DL, C48E, C6, C6D, C6DE, C6E, C6EBT, GS-X1011, GS-X1011-2, GS-X1011-WEH, GS-X1011-WEH-2, RSP40, RSP40A, SP35, SP35-2, SP35ALTA, SP35D, SP35DE, SP35E, SP40, SP40-2, SP40D, SP40D-2, SP40DDL, SP40DE, SP40DL, SP40E, SP5, SP5D, SP5DE, SP5E, SPB35, SPB35E		

1			
<b>GEV No.</b>	512265	<b>Ref. No.</b>	140106 H140108
<b>description</b>	connector holder		
<b>For models:</b>	C35, C35E, C43, C43-2, C43ALTA, C43D, C43DE, C43E, C46DE, C46E, C48, C48-2, C48D, C48D-2, C48DDL, C48DL, C6, C68DE, C68E, C6D, C6DE, C6E, CA120, CA55, CA90, ED550, ED650E, ED650S, RCA1100, RCA1200, RCA1200i, RSP40, RSP40A, SP35, SP35-2, SP35ALTA, SP35D, SP35DE, SP35E, SP40, SP40-2, SP40D, SP40D-2, SP40DDL, SP40DE, SP40DL, SP40E, SP5, SP5D, SP5DE... (Other models you can see in the webshop)		

1			
<b>GEV No.</b>	510323	<b>Ref. No.</b>	160734 33793
<b>description</b>	end cap for rinse arm		
<b>For models:</b>	C35, C35E, C43, C43-2, C43ALTA, C43D, C43DE, C43E, C46DE, C46E, C48, C48-2, C48D, C48D-2, C48DDL, C48DL, C48E, C6, C6D, C6DE, C6E, C6EBT, CDN3, CDN4, CR43, CR43D, CR48, CR48D, GS-X1011, GS-X1011-2, GS-X1011-WEH, GS-X1011-WEH-2, RSP40, RSP40A, SP35, SP35-2, SP35ALTA, SP35D, SP35DE, SP35E, SP40, SP40-2, SP40D, SP40D-2, SP40DDL, SP40DE, SP40DL, SP40E, SP5, SP5D... (Other models you can see in the webshop)		

1			
<b>GEV No.</b>	510321	<b>Ref. No.</b>	160736 H160736
<b>description</b>	end cap for wash arm		
<b>For models:</b>	C35, C35E, C43, C43-2, C43ALTA, C43D, C43DE, C43E, C46DE, C46E, C48, C48-2, C48D, C48D-2, C48DDL, C48DL, C48E, C6, C6D, C6DE, C6E, C6EBT, GS-X1011, GS-X1011-2, GS-X1011-WEH, GS-X1011-WEH-2, RSP40, RSP40A, SP35, SP35-2, SP35ALTA, SP35D, SP35DE, SP35E, SP40, SP40-2, SP40D, SP40D-2, SP40DDL, SP40DE, SP40DL, SP40E, SP5, SP5D, SP5DE, SP5E, SPB35, SPB35E		





			
<b>GEV No.</b>	510327	<b>Ref. No.</b>	170946 33791 H170946
<b>description</b>	nozzle for rinse arm		
<b>For models:</b>	C35, C35E, C43, C43-2, C43ALTA, C43D, C43DE, C43E, C46DE, C46E, C48, C48-2, C48D, C48D-2, C48DDL, C48DL, C48E, C6, C6D, C6DE, C6E, C6EBT, CDN3, CDN4, CR43, CR43D, CR48, CR48D, GS-X1011, GS-X1011-2, GS-X1011-WEH, GS-X1011-WEH-2, RSP40, RSP40A, SP35, SP35-2, SP35ALTA, SP35D, SP35DE, SP35E, SP40, SP40-2, SP40D, SP40D-2, SP40DDL, SP40DE, SP40DL, SP40E, SP5, SP5D...(Other models you can see in the webshop)		
<b>accessories for</b>	510327		
			
<b>GEV No.</b>	510902	<b>Ref. No.</b>	33790
<b>description</b>	O-ring EPDM thickness 2mm ID ø 9.5mm Qty 1 pcs		

			
<b>GEV No.</b>	510325	<b>Ref. No.</b>	170956 H170956
<b>description</b>	nozzle for wash arm		
<b>For models:</b>	C35, C35E, C43, C43-2, C43ALTA, C43D, C43DE, C43E, C46DE, C46E, C48, C48-2, C48D, C48D-2, C48DDL, C48DL, C48E, C6, C6D, C6DE, C6E, C6EBT, GS-X1011, GS-X1011-2, GS-X1011-WEH, GS-X1011-WEH-2, RSP40, RSP40A, SP35, SP35-2, SP35ALTA, SP35D, SP35DE, SP35E, SP40, SP40-2, SP40D, SP40D-2, SP40DDL, SP40DE, SP40DL, SP40E, SP5, SP5D, SP5DE, SP5E, SPB35, SPB35E		

			
<b>GEV No.</b>	510322	<b>Ref. No.</b>	27050
<b>description</b>	O-ring EPDM thickness 1.78mm ID ø 17.17mm Qty 1 pcs		
<b>For models:</b>	C35, C35E, C43, C43-2, C43ALTA, C43D, C43DE, C43E, C46DE, C46E, C48, C48-2, C48D, C48D-2, C48DDL, C48DL, C48E, C6, C6D, C6DE, C6E, C6EBT, E40-2F, ED600-95, ED700-90, ED900-90, EDI5, GS-X1011, GS-X1011-2, GS-X1011-WEH, GS-X1011-WEH-2, INDY43F, INDY48F, INDY53F, INDY60F, K80F, LO122, LO60, LO61, LO78, RSP40, RSP40A, SP35, SP35-2, SP35ALTA, SP35D, SP35DE, SP35E, SP40, SP40-2...(Other models you can see in the webshop)		

			
<b>GEV No.</b>	528583	<b>Ref. No.</b>	33792
<b>description</b>	O-ring EPDM thickness 2.62mm ID ø 9.13mm Qty 1 pcs		
<b>For models:</b>	C35, C35E, C43, C43-2, C43ALTA, C43D, C43DE, C43E, C46DE, C46E, C48, C48-2, C48D, C48D-2, C48DDL, C48DL, C48E, C6, C6D, C6DE, C6E, C6EBT, CDN3, CDN4, CR43, CR43D, CR48, CR48D, GS-X1011, GS-X1011-2, GS-X1011-WEH, GS-X1011-WEH-2, RSP40, RSP40A, SP35, SP35-2, SP35ALTA, SP35D, SP35DE, SP35E, SP40, SP40-2, SP40D, SP40D-2, SP40DDL, SP40DE, SP40DL, SP40E, SP5, SP5D...(Other models you can see in the webshop)		

			
<b>GEV No.</b>	510901	<b>Ref. No.</b>	H200843
<b>description</b>	O-ring EPDM thickness 2mm ID ø 13mm Qty 1 pcs		
<b>For models:</b>	C35, C35E, C43, C43-2, C43ALTA, C43D, C43DE, C43E, C46DE, C46E, C48, C48-2, C48D, C48D-2, C48DDL, C48DL, C48E, C6, C6D, C6DE, C6E, GS-X1011, GS-X1011-2, GS-X1011-WEH, GS-X1011-WEH-2, RSP40, RSP40A, SP35, SP35-2, SP35ALTA, SP35D, SP35DE, SP35E, SP40, SP40-2, SP40D, SP40D-2, SP40DDL, SP40DE, SP40DL, SP40E, SP5, SP5D, SP5DE, SP5E, SPB35, SPB35E		

			
<b>GEV No.</b>	510902	<b>Ref. No.</b>	33790
<b>description</b>	O-ring EPDM thickness 2mm ID ø 9.5mm Qty 1 pcs		
<b>For models:</b>	C35, C35E, C43, C43-2, C43ALTA, C43D, C43DE, C43E, C46DE, C46E, C48, C48-2, C48D, C48D-2, C48DDL, C48DL, C48E, C6, C6D, C6DE, C6E, C6EBT, C6E, C6EBT, C90, C90DE, C90E, C90EBT, CDN3, CDN4, CR43, CR43D, CR48, CR48D, EDI13, EDI13ALTA, EDI6, EDI8, GS-X1011, GS-X1011-2, GS-X1011-WEH, GS-X1011-WEH-2, LO134, LO134ALTA, LO50, LO50E, LO67, LO83, RLO200...(Other models you can see in the webshop)		

			
<b>GEV No.</b>	510307	<b>Ref. No.</b>	261009 H261009
<b>description</b>	Thumb screw thread M6 H 3mm thread L 8mm ø 28mm SS		
<b>For models:</b>	C35, C35E, C43, C43-2, C43ALTA, C43D, C43DE, C43E, C46DE, C46E, C48, C48-2, C48D, C48D-2, C48DDL, C48DL, C48E, C6, C6D, C6DE, C6E, C6EBT, C6D, C6DE, C6E, C6EBT, C90DE2, C90E2, C90EBT2, C98, CA120, CA55, CA90, CAP10, CAP10BT, CAP10DE, CAP12, CAP12DE, CAP12EBT, CAP15EBT, CAP7, CAP7E, ED550, ED650E, ED650S, EDI13-2, EDI13ALTA-2, EDI13ALTABT, EDI13BT, EDI4, EDI6-2...(Other models you can see in the webshop)		









			
<b>GEV No.</b>	510747	<b>Ref. No.</b>	H420545
<b>description</b>	wash and rinse arm wash arm L 410mm rinse arm L 410mm mounting pos. lower w. jets 6 r. jets 4 mounting ø 12/45mm nozzle type C		
<b>spare parts for</b>	510747		
			
<b>GEV No.</b>	510300	<b>Ref. No.</b>	—
<b>description</b>	end cap for wash arm		
			
<b>GEV No.</b>	510302	<b>Ref. No.</b>	29670 H200823 H200824
<b>description</b>	O-ring EPDM ID ø 12.42mm thickness 1.78mm Qty 1 pcs		
			
<b>GEV No.</b>	510303	<b>Ref. No.</b>	31014 456030 H200818
<b>description</b>	O-ring EPDM thickness 1.78mm ID ø 6.75mm Qty 1 pcs		
			
<b>GEV No.</b>	510305	<b>Ref. No.</b>	H180213
<b>description</b>	opposite support for wash jet		
			
<b>GEV No.</b>	510307	<b>Ref. No.</b>	261009 H261009
<b>description</b>	Thumb screw thread M6 H 3mm thread L 8mm ø 28mm SS		
			
<b>GEV No.</b>	510309	<b>Ref. No.</b>	170911 H170911
<b>description</b>	nozzle for rinse arm mounting pos. right/left		
			
<b>GEV No.</b>	510310	<b>Ref. No.</b>	170704 H170704
<b>description</b>	opposite support for rinse jet		
			
<b>GEV No.</b>	510313	<b>Ref. No.</b>	190617 H190617
<b>description</b>	bush H 12mm D1 ø 20mm D2 ø 16mm D3 ø 12mm for wash arm boss		

Table continues overleaf

spare parts for		510747		
	GEV No.	510315	Ref. No.	170929 H170929
nozzle for rinse arm mounting pos. centre/inside				
	GEV No.	510316	Ref. No.	—
blank nozzle mounting pos. centre for wash arm				
	GEV No.	510317	Ref. No.	170930 H170930
blank nozzle mounting pos. centre for rinse arm				
	GEV No.	510752	Ref. No.	—
wash jet mounting pos. right				
	GEV No.	510753	Ref. No.	—
wash jet mounting pos. left				
	GEV No.	510871	Ref. No.	H191022
wash arm boss				
	GEV No.	512265	Ref. No.	140106 H140108
connector holder				
	GEV No.	560140	Ref. No.	30194
hexagonal nut thread M4 H 4.8mm SS W5 7 Qty 20 pcs DIN/ISO DIN 985 self-locking				

	GEV No.	510317	Ref. No.	170930 H170930
description blank nozzle mounting pos. centre for rinse arm				
For models: C68DE, C68E, CA120, CA55, CA90, ED550, ED650E, ED650S, RCA1100, RCA1200, RCA1200i, SP68DE, SP68E				

	GEV No.	510313	Ref. No.	190617 H190617
description bush H 12mm D1 ø 20mm D2 ø 16mm D3 ø 12mm for wash arm boss				
For models: 60EBT, C53DE, C53E, C60DE, C60E, C68DE, C68E, CA120, CA55, CA90, DP45DE, DP45E, DP50DE, DP50E, DP50EBT, ED550, ED650E, ED650S, RCA1100, RCA1200, RCA1200i, SP45DE, SP45E, SP50DE, SP50E, SP50E-400V3-50Hz-MARINE, SP50E-440V3-60Hz-MARINE, SP68DE, SP68E, ST53DE, ST53E, ST60DE, ST60E, ST60EBT				

	GEV No.	512265	Ref. No.	140106 H140108
description connector holder				
For models: C35, C35E, C43, C43-2, C43ALTA, C43D, C43DE, C43E, C46DE, C46E, C48, C48-2, C48D, C48D-2, C48DDL, C48DL, C6, C68DE, C68E, C6D, C6DE, C6E, CA120, CA55, CA90, ED550, ED650E, ED650S, RCA1100, RCA1200, RCA1200i, RSP40, RSP40A, SP35, SP35-2, SP35ALTA, SP35D, SP35DE, SP35E, SP40, SP40-2, SP40D, SP40D-2, SP40DDL, SP40DE, SP40DL, SP40E, SP5, SP5D, SP5DE...(Other models you can see in the webshop)				

Зип Общепит

	GEV No.	510315	Ref. No.	170929 H170929
description nozzle for rinse arm mounting pos. centre/inside				
For models: C68DE, C68E, CA120, CA55, CA90, ED550, ED650E, ED650S, RCA1100, RCA1200, RCA1200i, SP68DE, SP68E				

	GEV No.	510309	Ref. No.	170911 H170911
description nozzle for rinse arm mounting pos. right/left				
For models: C68DE, C68E, C81E, C81EBT, C90, C90DE, C90DE2, C90E, C90E2, C90EBT, C90EBT2, C98, CA120, CA55, CA90, ED550, ED650E, ED650S, LO50, LO50E, LO62, RCA1100, RCA1200, RCA1200i, RLO50, SMW15, SMW15E, SP68DE, SP68E, SP81E, US-X501				

	GEV No.	510310	Ref. No.	170704 H170704
description opposite support for rinse jet				
For models: C68DE, C68E, C81E, C81EBT, C90, C90DE, C90DE2, C90E, C90E2, C90EBT, C90EBT2, C98, CA120, CA55, CA90, ED550, ED650E, ED650S, LO50, LO50E, LO62, RCA1100, RCA1200, RCA1200i, RLO50, SMW15, SMW15E, SP68DE, SP68E, SP81E, US-X501				

	GEV No.	510305	Ref. No.	H180213
description opposite support for wash jet				

	GEV No.	510302	Ref. No.	29670 H200823 H200824
description O-ring EPDM ID ø 12.42mm thickness 1.78mm Qty 1 pcs				
For models: AP43E, AP48E, AP53E, AP60E, APS43, APS48, APS48B, APS53, APS60, APSE43, APSE48, APSE53, APSE60, BPS43, BPS52, C68DE, C68E, E40-2F, EDT100, EDT140, EDT85, FW35, FW35E, FW40, FW40B, FW40E, FW45, FW50, INDY43F, INDY48F, INDY53F, INDY60F, SP68DE, SP68E, TR100, TR140, TR90, TR-E100, TR-E150, TR-E170, TR-E200, TR-E230, TS43, TS48, UNI43C, UNI48C, UNI48CD, UNI53C, UNI60C				

	GEV No.	510303	Ref. No.	31014 456030 H200818
description O-ring EPDM thickness 1.78mm ID ø 6.75mm Qty 1 pcs				
For models: APS43, APS48, APS48B, APS53, APS60, BPS43, C68DE, C68E, C81E, C81EBT, C90, C90DE, C90DE2, C90E, C90E2, C90EBT, C90EBT2, C98, CA120, CA55, CA90, ED550, ED650E, ED650S, FW35, FW40, FW40B, FW45, FW50, LO50, LO50E, LO62, RCA1100, RCA1200, RCA1200i, RLO50, SMW15, SMW15E, SP68DE, SP68E, SP81E, TS43, TS48, US-X501				









Зип Общепит

vsezip.ru

+7(812)987008-81

			
1			
<b>GEV No.</b>	510307	<b>Ref. No.</b>	261009 H261009
<b>description</b>	Thumb screw thread M6 H 3mm thread L 8mm ø 28mm SS		
<b>For models:</b>	C35, C35E, C43, C43-2, C43ALTA, C43D, C43DE, C43E, C46DE, C46E, C48, C48-2, C48D, C48D-2, C48DDL, C48DL, C48E, C6, C68DE, C68E, C68EBT, C6D, C6DE, C6E, C6EBT, C90DE2, C90E2, C90EBT2, C98, CA120, CA55, CA90, CAP10, CAP10BT, CAP10DE, CAP12, CAP12DE, CAP12EBT, CAP15EBT, CAP7, CAP7E, ED550, ED650E, ED650S, EDI13-2, EDI13ALTA-2, EDI13ALTABT, EDI13BT, EDI4, EDI6-2...(Other models you can see in the webshop)		

<b>spare parts for</b> 510272			
	<b>GEV No.</b>	560052	<b>Ref. No.</b> —
	side bolts thread M5 L 10mm SS Qty 20 pcs intake slotted head ø 2.5mm		
	<b>GEV No.</b>	560140	<b>Ref. No.</b> 30194
	hexagonal nut thread M4 H 4.8mm SS WS 7 Qty 20 pcs DIN/ISO DIN 985 self-locking		
	<b>GEV No.</b>	560454	<b>Ref. No.</b> —
	flat-headed bolt thread M4 thread L 22mm SS DIN 84/ISO 1207 Qty 1 pcs intake slotted head ø 7mm head thickness 2.5mm		

			
1			
<b>GEV No.</b>	510871	<b>Ref. No.</b>	H191022
<b>description</b>	wash arm boss		

			
1			
<b>GEV No.</b>	510317	<b>Ref. No.</b>	170930 H170930
<b>description</b>	blank nozzle mounting pos. centre for rinse arm		
<b>For models:</b>	C68DE, C68E, CA120, CA55, CA90, ED550, ED650E, ED650S, RCA1100, RCA1200, RCA1200i, SP68DE, SP68E		

			
1			
<b>GEV No.</b>	510272	<b>Ref. No.</b>	33479
<b>description</b>	rinse arm L 500mm mounting pos. upper/lower nozzles 6 mounting ø 12mm		
<b>For models:</b>	CA55, CA90, ED550, ED650E, RCA1100, RCA1200, RCA1200i		

			
1			
<b>GEV No.</b>	510313	<b>Ref. No.</b>	190617 H190617
<b>description</b>	bush H 12mm D1 ø 20mm D2 ø 16mm D3 ø 12mm for wash arm boss		
<b>For models:</b>	60EBT, C53DE, C53E, C60DE, C60E, C68DE, C68E, CA120, CA55, CA90, DP45DE, DP45E, DP50DE, DP50E, DP50EBT, ED550, ED650E, ED650S, RCA1100, RCA1200, RCA1200i, SP45DE, SP45E, SP50DE, SP50E, SP50E-400V3-50Hz-MARINE, SP50E-440V3-60Hz-MARINE, SP68DE, SP68E, ST53DE, ST53E, ST60DE, ST60E, ST60EBT		

<b>spare parts for</b> 510272			
	<b>GEV No.</b>	508122	<b>Ref. No.</b> —
	end cap		
	<b>GEV No.</b>	510303	<b>Ref. No.</b> 31014 456030 H200818
	O-ring EPDM thickness 1.78mm ID ø 6.75mm Qty 1 pcs		
	<b>GEV No.</b>	510307	<b>Ref. No.</b> 261009 H261009
	Thumb screw thread M6 H 3mm thread L 8mm ø 28mm SS		
	<b>GEV No.</b>	510309	<b>Ref. No.</b> 170911 H170911
	nozzle for rinse arm mounting pos. right/left		
	<b>GEV No.</b>	510310	<b>Ref. No.</b> 170704 H170704
	opposite support for rinse jet		
	<b>GEV No.</b>	510313	<b>Ref. No.</b> 190617 H190617
	bush H 12mm D1 ø 20mm D2 ø 16mm D3 ø 12mm for wash arm boss		
	<b>GEV No.</b>	510315	<b>Ref. No.</b> 170929 H170929
	nozzle for rinse arm mounting pos. centre/inside		
	<b>GEV No.</b>	510317	<b>Ref. No.</b> 170930 H170930
	blank nozzle mounting pos. centre for rinse arm		
	<b>GEV No.</b>	510872	<b>Ref. No.</b> 191030 H191030
	rinse arm boss		

			
1			
<b>GEV No.</b>	510315	<b>Ref. No.</b>	170929 H170929
<b>description</b>	nozzle for rinse arm mounting pos. centre/inside		
<b>For models:</b>	C68DE, C68E, CA120, CA55, CA90, ED550, ED650E, ED650S, RCA1100, RCA1200, RCA1200i, SP68DE, SP68E		

			
1			
<b>GEV No.</b>	510309	<b>Ref. No.</b>	170911 H170911
<b>description</b>	nozzle for rinse arm mounting pos. right/left		
<b>For models:</b>	C68DE, C68E, C81E, C81EBT, C90, C90DE, C90DE2, C90E, C90E2, C90EBT, C90EBT2, C98, CA120, CA55, CA90, ED550, ED650E, ED650S, LO50, LO50E, LO62, RCA1100, RCA1200, RCA1200i, RLO50, SMW15, SMW15E, SP68DE, SP68E, SP81E, US-X501		



			
1			
<b>GEV No.</b>	510310	<b>Ref. No.</b>	170704 H170704
<b>description</b>	opposite support for rinse jet		
<b>For models:</b>	C68DE, C68E, C81E, C81EBT, C90, C90DE, C90DE2, C90E, C90E2, C90EBT, C90EBT2, C98, CA120, CA55, CA90, ED550, ED650E, ED650S, LO50, LO50E, LO62, RCA1100, RCA1200, RCA1200i, RLO50, SMW15, SMW15E, SP68DE, SP68E, SP81E, US-X501		



			
1			
<b>GEV No.</b>	510303	<b>Ref. No.</b>	31014 456030 H200818
<b>description</b>	O-ring EPDM thickness 1.78mm ID ø 6.75mm Qty 1 pcs		
<b>For models:</b>	APS43, APS48, APS48B, APS53, APS60, BPS43, C68DE, C68E, C81E, C81EBT, C90, C90DE, C90DE2, C90E, C90E2, C90EBT, C90EBT2, C98, CA120, CA55, CA90, ED550, ED650E, ED650S, FW35, FW40, FW40B, FW45, FW50, LO50, LO50E, LO62, RCA1100, RCA1200, RCA1200i, RLO50, SMW15, SMW15E, SP68DE, SP68E, SP81E, TS43, TS48, US-X501		





			
1			
<b>GEV No.</b>	510872	<b>Ref. No.</b>	191030 H191030
<b>description</b>	rinse arm boss		
<b>For models:</b>	CA120, CA55, CA90, ED550, ED650E, ED650S, RCA1100, RCA1200, RCA1200i		

			
1			
<b>GEV No.</b>	510307	<b>Ref. No.</b>	261009 H261009
<b>description</b>	Thumb screw thread M6 H 3mm thread L 8mm ø 28mm SS		
<b>For models:</b>	C35, C35E, C43, C43-2, C43ALTA, C43D, C43DE, C43E, C46DE, C46E, C48, C48-2, C48D, C48D-2, C48DDL, C48DL, C48E, C6, C68DE, C68E, C68EBT, C6D, C6DE, C6E, C6EBT, C90DE2, C90E2, C90EBT2, C98, CA120, CA55, CA90, CAP10, CAP10BT, CAP10DE, CAP12, CAP12DE, CAP12EBT, CAP15EBT, CAP7, CAP7E, ED550, ED650E, ED650S, EDI13-2, EDI13ALTA-2, EDI13ALTABT, EDI13BT, EDI4, EDI6-2...(Other models you can see in the webshop)		

			
1			
<b>GEV No.</b>	512222	<b>Ref. No.</b>	21899
<b>description</b>	wash arm L 290mm nozzles 4 mounting ø 14/27mm mounting pos. upper		
<b>For models:</b>	APS43, APS48B, APSE43, FW35		

			
1			
<b>GEV No.</b>	512223	<b>Ref. No.</b>	21866
<b>description</b>	wash arm L 345mm nozzles 4 mounting ø 26.5mm mounting pos. upper		
<b>For models:</b>	APS43, APS48, APS48B, APS53, APSE43, APSE48, APSE53, FW35, FW40, FW40B, FW45		
<b>spare parts for</b>	512223		
	<b>GEV No.</b>	512091	<b>Ref. No.</b>
			30516

<b>spare parts for</b> 512225			
	<b>GEV No.</b>	512194	<b>Ref. No.</b>
			32360
rinse arm boss ø 84mm H 30mm			
	<b>GEV No.</b>	512231	<b>Ref. No.</b>
			29156
wash jet			
	<b>GEV No.</b>	512240	<b>Ref. No.</b>
			32282
bush for rinse arm			

			
1			
<b>GEV No.</b>	512225	<b>Ref. No.</b>	21867
<b>description</b>	wash arm L 415mm nozzles 5 mounting ø 26.5mm mounting pos. lower		
<b>For models:</b>	APS48, APS48B, APS53, APSE48, FW40, FW40B		
<b>spare parts for</b>	512225		
	<b>GEV No.</b>	512091	<b>Ref. No.</b>
			30516
end cap			
	<b>GEV No.</b>	512194	<b>Ref. No.</b>
			32360
rinse arm boss ø 84mm H 30mm			
	<b>GEV No.</b>	512231	<b>Ref. No.</b>
			29156
wash jet			
	<b>GEV No.</b>	512240	<b>Ref. No.</b>
			32282
bush for rinse arm			
	<b>GEV No.</b>	512278	<b>Ref. No.</b>
			18345
shim			













			
1			
<b>GEV No.</b>	512227	<b>Ref. No.</b>	21884
<b>description</b>	wash arm L 472mm nozzles 5 mounting ø 14/26mm mounting pos. lower		
<b>For models:</b>	APS60, APSE60, FW50		
<b>spare parts for</b>	512227		
	<b>GEV No.</b>	512091	<b>Ref. No.</b>
			30516
end cap			
	<b>GEV No.</b>	512157	<b>Ref. No.</b>
			15362
nut thread M12			

Table continues overleaf





spare parts for 512227	
	GEV No. 512158 Ref. No. 29358 rinse jet holder L 70mm nozzles 1 mounting ø 12mm mounting pos. lower
	GEV No. 512231 Ref. No. 29156 wash jet
	GEV No. 512241 Ref. No. 17920 screw







 <p>1</p>	
<b>GEV No.</b>	512226 <b>Ref. No.</b> 21868
<b>description</b>	wash arm L 485mm nozzles 6 mounting ø 14/27mm mounting pos. lower
<b>For models:</b>	APS53, APSE53, FW45
spare parts for 512226	
	GEV No. 512091 Ref. No. 30516 end cap
	GEV No. 512194 Ref. No. 32360 rinse arm boss ø 84mm H 30mm
	GEV No. 512231 Ref. No. 29156 wash jet
	GEV No. 512240 Ref. No. 32282 bush for rinse arm

 <p>1</p>	
<b>GEV No.</b>	512091 <b>Ref. No.</b> 30516
<b>description</b>	end cap
<b>For models:</b>	APS43, APS48, APS48B, APS53, APS60, APSE43, APSE48, APSE53, APSE60, C3, C35, C4, C43, C43D, C48, C48D, C53, C53D, C60, C60D, DP35, DP35D, DP40, DP40D, DP45, DP45D, DP50, DP50D, FW35, FW40, FW40B, FW45, FW50, SP35, SP35D, SP40, SP40D, SP45, SP45D, SP50, SP50-400V, SP50-440V, SP50D, SPB35, STS43, STS43D, STS48, STS48D, STS53, STS53D...(Other models you can see in the webshop)

 <p>1</p>	
<b>GEV No.</b>	512020 <b>Ref. No.</b> 25111
<b>description</b>	end cap for rinse arm
<b>For models:</b>	APS43, APS48, APS53, APS60, APSE43, APSE48, APSE53, APSE60, BPN48, BPS43, BPS52, C3, C4, E40-2F, M60, T3-80, T4-80, T5-80, T6-80

 <p>1</p>	
<b>GEV No.</b>	512231 <b>Ref. No.</b> 29156
<b>description</b>	wash jet
<b>For models:</b>	APS43, APS48, APS48B, APS53, APS60, APSE43, APSE48, APSE53, APSE60, FW35, FW40, FW40B, FW45, FW50

 <p>1</p>	
<b>GEV No.</b>	512001 <b>Ref. No.</b> 20502/R
<b>description</b>	rinse arm complete

 <p>1</p>	
<b>GEV No.</b>	512228 <b>Ref. No.</b> 21863
<b>description</b>	rinse arm L 345mm mounting ø 34.5mm nozzles 4 mounting pos. lower
<b>For models:</b>	APS43, APS48, APS48B, APS53, APSE43, C3, DP35, DP35D, FW35, STS43, STS43D, STS48, STS48D
spare parts for 512228	
	GEV No. 512079 Ref. No. 29695 rinse jet
	GEV No. 512091 Ref. No. 30516 end cap
	GEV No. 512194 Ref. No. 32360 rinse arm boss ø 84mm H 30mm
	GEV No. 512238 Ref. No. 17917 34351 rinse arm shaft
	GEV No. 512244 Ref. No. 32359 nut for wash arm
	GEV No. 512278 Ref. No. 18345 shim





1

<b>GEV No.</b>	512229	<b>Ref. No.</b>	21864
<b>description</b>	rinse arm L 420mm mounting $\varnothing$ 14/34.5mm nozzles 5 mounting pos. lower		
<b>For models:</b>	APS48, APS48B, APS53, APSE48, C4, DP40, DP40D, DP45, FW40, FW40B, STS48, STS48D, STS53		
<b>spare parts for</b>	512229		
	<b>GEV No.</b>	512079	<b>Ref. No.</b> 29695
			rinse jet
	<b>GEV No.</b>	512091	<b>Ref. No.</b> 30516
			end cap
	<b>GEV No.</b>	512194	<b>Ref. No.</b> 32360
			rinse arm boss $\varnothing$ 84mm H 30mm
	<b>GEV No.</b>	512238	<b>Ref. No.</b> 17917 34351
			rinse arm shaft
	<b>GEV No.</b>	512244	<b>Ref. No.</b> 32359
			nut for wash arm
	<b>GEV No.</b>	512278	<b>Ref. No.</b> 18345
			shim
	<b>GEV No.</b>	517622	<b>Ref. No.</b> 32178
			rinse arm L 180mm nozzles 3 mounting $\varnothing$ 19mm





1

<b>GEV No.</b>	512014	<b>Ref. No.</b>	21865
<b>description</b>	rinse arm L 485mm mounting $\varnothing$ 14mm nozzles 6 mounting pos. lower		
<b>For models:</b>	APS53, APS60, APSE53, C53, C53D, C60, C60D, DP45, DP45D, DP50, DP50D, FW45, FW50, SP45, SP45D, SP50, SP50-400V, SP50-440V, SP50D, STS53, STS53D, STS60, STS60D		
<b>spare parts for</b>	512014		
	<b>GEV No.</b>	512079	<b>Ref. No.</b> 29695
			rinse jet
	<b>GEV No.</b>	512091	<b>Ref. No.</b> 30516
			end cap
	<b>GEV No.</b>	512194	<b>Ref. No.</b> 32360
			rinse arm boss $\varnothing$ 84mm H 30mm

Зип-Общепит

vsezip.ru

+7(812)987-08-81

	<b>GEV No.</b>	512238	<b>Ref. No.</b>	17917 34351
				rinse arm shaft
	<b>GEV No.</b>	512244	<b>Ref. No.</b>	32359
				nut for wash arm
	<b>GEV No.</b>	512278	<b>Ref. No.</b>	18345
				shim



1

<b>GEV No.</b>	512167	<b>Ref. No.</b>	20901 21892
<b>description</b>	rinse arm L 520mm mounting $\varnothing$ 10mm nozzles 6 mounting pos. upper/lower		
<b>For models:</b>	ED650E, ED650S, K80F		



1

<b>GEV No.</b>	512230	<b>Ref. No.</b>	21882
<b>description</b>	rinse arm L 520mm mounting $\varnothing$ 14mm nozzles 6 mounting pos. lower		
<b>For models:</b>	APS60, APSE60, FW50		



1

<b>GEV No.</b>	512091	<b>Ref. No.</b>	30516
<b>description</b>	end cap		
<b>For models:</b>	APS43, APS48, APS48B, APS53, APS60, APSE43, APSE48, APSE53, APSE60, C3, C35, C4, C43, C43D, C48, C48D, C53, C53D, C60, C60D, DP35, DP35D, DP40, DP40D, DP45, DP45D, DP50, DP50D, FW35, FW40, FW40B, FW45, FW50, SP35, SP35D, SP40, SP40D, SP45, SP45D, SP50, SP50-400V, SP50-440V, SP50D, SPB35, STS43, STS43D, STS48, STS48D, STS53, STS53D...(Other models you can see in the webshop)		



1

<b>GEV No.</b>	512156	<b>Ref. No.</b>	29348
<b>description</b>	rinse arm L 138mm nozzles 1 mounting $\varnothing$ 22mm mounting pos. lower		
<b>For models:</b>	ED650E, ED650S, K80F		





Зип Общепит

vsezip.ru

+7(812)987-08-81







			
1			
<b>GEV No.</b>	517622	<b>Ref. No.</b>	32178
<b>description</b>	rinse arm L 180mm nozzles 3 mounting ø 19mm		
<b>For models:</b>	APS43, APS48, APS48B, APS53, APSE43, APSE48, APSE53, BPN49, BPS43, BPS52, C3, C4, DP35, DP35D, DP40, DP40D, DP45, DP45D, DP50, DP50D, FW35, FW40, FW40B, FW45, STS43, STS43D, STS48, STS48D, STS53, STS53D, STS60, STS60D		

			
1			
<b>GEV No.</b>	517794	<b>Ref. No.</b>	32179
<b>description</b>	rinse arm mounting pos. lower L 180mm nozzles 2 mounting ø 19mm		
<b>For models:</b>	APS43, APS48, APS48B, APS53, APSE43, APSE48, APSE53, BPN48, BPS43, BPS52, C3, C4, DP35, DP35D, DP40, DP40D, DP45, DP45D, DP50, DP50D, FW35, FW40, FW40B, FW45, STS43, STS43D, STS48, STS48D, STS53, STS53D, STS60, STS60D		

			
1			
<b>GEV No.</b>	512194	<b>Ref. No.</b>	32360
<b>description</b>	rinse arm boss ø 84mm H 30mm		
<b>For models:</b>	APS43, APS48, APS48B, APS53, APS60, APSE43, APSE48, APSE53, APSE60, C3, C4, C53, C53D, C60, C60D, DP35, DP35D, DP40, DP40D, DP45, DP45D, DP50, DP50D, FW35, FW40, FW40B, FW45, FW50, SP45, SP45D, SP50, SP50-400V, SP50-440V, SP50D, STS43, STS43D, STS48, STS48D, STS53, STS53D, STS60, STS60D		

			
1			
<b>GEV No.</b>	512079	<b>Ref. No.</b>	29695
<b>description</b>	rinse jet		
<b>For models:</b>	APS43, APS48, APS48B, APS53, APS60, APSE43, APSE48, APSE53, APSE60, C3, C35, C4, C43, C43D, C48, C48D, C53, C53D, C60, C60D, DP35, DP35D, DP40, DP40D, DP45, DP45D, DP50, DP50D, ED600-95, ED630-90, ED650E, ED650S, ED700-90, ED900-90, EDI5, FW35, FW40, FW40B, FW45, FW50, K80F, LO122, LO60, LO61, LO78, SP35, SP35D, SP40, SP40D, SP45...(Other models you can see in the webshop)		

			
1			
<b>GEV No.</b>	512330	<b>Ref. No.</b>	26463
<b>description</b>	rinse jet		
<b>For models:</b>	ED650E-90, ED650S-90, ED700, ED900		

			
1			
<b>GEV No.</b>	512013	<b>Ref. No.</b>	20095
<b>description</b>	rinse arm L 280mm mounting ø 11mm nozzles 4 mounting pos. upper/lower complete		
<b>For models:</b>	C35, C43, C43D, C48, C48D, SP35, SP35D, SP40, SP40D, SPB35, T3-80		
<b>spare parts for</b>	512013		
	<b>GEV No.</b>	512019	<b>Ref. No.</b> 25109
	<b>GEV No.</b>	512079	<b>Ref. No.</b> 29695
	<b>GEV No.</b>	512087	<b>Ref. No.</b> 25110
	<b>GEV No.</b>	512091	<b>Ref. No.</b> 30516
<b>accessories for</b>	512013		
	<b>GEV No.</b>	512092	<b>Ref. No.</b> 33748
	<b>GEV No.</b>	512256	<b>Ref. No.</b> 33747









			
1			
<b>GEV No.</b>	512284	<b>Ref. No.</b>	20096
<b>description</b>	rinse arm L 335mm mounting ø 11.5mm nozzles 4 mounting pos. upper		
<b>For models:</b>	T3-80, T4-80		
<b>spare parts for</b>	512284		
	<b>GEV No.</b>	512019	<b>Ref. No.</b> 25109
	<b>GEV No.</b>	512020	<b>Ref. No.</b> 25111
	<b>GEV No.</b>	512080	<b>Ref. No.</b> 21021 25136
	<b>GEV No.</b>	512087	<b>Ref. No.</b> 25110

Table continues overleaf

spare parts for		512284		
	GEV No.	512094	Ref. No.	22155 25059
	rinse jet			
	GEV No.	512304	Ref. No.	—
	rinse jet			







1

GEV No.	512285	Ref. No.	20097	
description	rinse arm L 410mm mounting ø 12mm nozzles 5 mounting pos. lower			
For models:	T4-80, T5-80			
spare parts for		512285		
	GEV No.	510196	Ref. No.	25069
	rinse jet			
	GEV No.	512019	Ref. No.	25109
	rinse arm boss			
	GEV No.	512020	Ref. No.	25111
	end cap for rinse arm			
	GEV No.	512087	Ref. No.	25110
	nut thread M12			



1



GEV No.	512208	Ref. No.	20098	
description	rinse arm L 477mm mounting ø 12mm nozzles 6 mounting pos. lower			
For models:	M60, T5-80, T6-80			
spare parts for		512208		
	GEV No.	512019	Ref. No.	25109
	rinse arm boss			
	GEV No.	512020	Ref. No.	25111
	end cap for rinse arm			
	GEV No.	512080	Ref. No.	21021 25136
	rinse jet			
	GEV No.	512087	Ref. No.	25110
	nut thread M12			
	GEV No.	512094	Ref. No.	22155 25059
	rinse jet			

Зип-Общепит

spare parts for		512208		
	GEV No.	512282	Ref. No.	—
	rinse jet			



1

GEV No.	512161	Ref. No.	20099	
description	rinse arm L 515mm mounting ø 12mm nozzles 6 mounting pos. lower			
For models:	M60, T6-80			
spare parts for		512161		
	GEV No.	512019	Ref. No.	25109
	rinse arm boss			
	GEV No.	512020	Ref. No.	25111
	end cap for rinse arm			
	GEV No.	512082	Ref. No.	25062
	swirl			
	GEV No.	512087	Ref. No.	25110
	nut thread M12			
	GEV No.	512094	Ref. No.	22155 25059
	rinse jet			
	GEV No.	512136	Ref. No.	25179 25789
	wing nuts for filter			
	GEV No.	512282	Ref. No.	—
	rinse jet			

1

GEV No.	512091	Ref. No.	30516
description	end cap		
For models:	APS43, APS48, APS48B, APS53, APS60, APSE43, APSE48, APSE53, APSE60, C3, C35, C4, C43, C43D, C48, C48D, C53, C53D, C60, C60D, DP35, DP35D, DP40, DP40D, DP45, DP45D, DP50, DP50D, FW35, FW40, FW40B, FW45, FW50, SP35, SP35D, SP40, SP40D, SP45, SP45D, SP50, SP50-400V, SP50-440V, SP50D, SPB35, STS43, STS43D, STS48, STS48D, STS53, STS53D...(Other models you can see in the webshop)		

1

GEV No.	512019	Ref. No.	25109
description	rinse arm boss		
For models:	C35, C43, C43D, C48, C48D, M60, SP35, SP35D, SP40, SP40D, SPB35, T3-80, T4-80, T5-80, T6-80		



Зип Общепит  
vsezip.ru  
8(12)987-08-81

1			
<b>GEV No.</b>	512079	<b>Ref. No.</b>	29695
<b>description</b>	rinse jet		
<b>For models:</b>	APS43, APS48, APS48B, APS53, APS60, APSE43, APSE48, APSE53, APSE60, C3, C35, C4, C43, C43D, C48, C48D, C53, C53D, C60, C60D, DP35, DP35D, DP40, DP40D, DP45, DP45D, DP50, DP50D, ED630-90, ED630-90D, ED650E, ED650S, ED700-90, ED900-90, EDI5, FW35, FW40, FW40B, FW45, FW50, K80F, LO122, LO60, LO61, LO78, SP35, SP35D, SP40, SP40D, SP45...(Other models you can see in the webshop)		

1			
<b>GEV No.</b>	512163	<b>Ref. No.</b>	20108
<b>description</b>	wash arm		
<b>For models:</b>	CM52, CMD52, E50, NK52, NKD52, UNI53R, UNI53RD		

1			
<b>GEV No.</b>	512080	<b>Ref. No.</b>	21021 25136
<b>description</b>	rinse jet		
<b>For models:</b>	APS43, APS48, APS48B, APS53, APSE43, C3, C4, CM43, CM48, CM52, CM60, CMD43, CMD48, CMD52, CMD60, E36, E40, E40-2F, E43, E50, FW35, FW40, FW40B, FW45, INDY43F, K80G, M60, NK43, NK48, NK52, NK60, NKD43, NKD48, NKD52, NKD60, T3-80, T4-80, T5-80, T6-80, TS43, UNI43C, UNI43R, UNI43RD, UNI48R, UNI48RD, UNI53R, UNI53RD		

1			
<b>GEV No.</b>	512180	<b>Ref. No.</b>	25076
<b>description</b>	wash arm H 125mm L 260mm mounting ø 40mm nozzles 3 mounting pos. lower		
<b>For models:</b>	CM43, CMD43, E36, E40, E43, NK43, NKD43, UNI43R, UNI43RD		

1			
<b>GEV No.</b>	512094	<b>Ref. No.</b>	22155 25059
<b>description</b>	rinse jet		
<b>For models:</b>	APS43, APS48, APS48B, APS53, APS60, C53, C53D, C60, C60D, CM43, CM48, CM52, CM60, CMD43, CMD48, CMD52, CMD60, DP35, DP35D, DP40, DP40D, DP45, DP45D, DP50, DP50D, E36, E40, E43, E50, ED650E-90, ED650S-90, ED700, ED900, FW35, FW40, FW40B, FW45, FW50, K80G, NK43, NK48, NK52, NK60, NKD43, NKD48, NKD52, NKD60, SP45, SP45D, SP50...(Other models you can see in the webshop)		

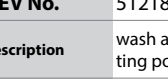
1			
<b>GEV No.</b>	512216	<b>Ref. No.</b>	20107
<b>description</b>	wash arm H 525mm L 280mm mounting ø 38.5mm nozzles 13 mounting pos. lower		
<b>For models:</b>	CM48, CMD48, NK48, NKD48, UNI48R, UNI48RD		

1			
<b>GEV No.</b>	512082	<b>Ref. No.</b>	25062
<b>description</b>	swirl		
<b>For models:</b>	APS43, APS48, APS53, APS60, APSE43, APSE48, APSE53, APSE60, C3, C4, C53, C60, ED700, ED900, INDY43F, INDY53F, INDY60F, M60, T3-80, T4-80, T5-80, T6-80, UNI43C, UNI48C, UNI48CD, UNI53C, UNI60C		

1			
<b>GEV No.</b>	512218	<b>Ref. No.</b>	25080
<b>description</b>	end cap		
<b>For models:</b>	CM48, CM52, CM60, CMD48, CMD52, CMD60, E50, NK48, NK52, NK60, NKD48, NKD52, NKD60, UNI48R, UNI48RD, UNI53R, UNI53RD		

1			
<b>GEV No.</b>	512162	<b>Ref. No.</b>	20106
<b>description</b>	wash arm		
<b>For models:</b>	CM43, CMD43, E36, E40, E43, NK43, NKD43, UNI43R, UNI43RD		

1			
<b>GEV No.</b>	512217	<b>Ref. No.</b>	25259
<b>description</b>	flat gasket rubber ED ø 61mm ID ø 47.5mm thickness 3mm Qty 1 pcs equiv. no. 25259 suitable for HOONVED		
<b>For models:</b>	CM43, CM48, CM52, CM60, CMD43, CMD48, CMD52, CMD60, E36, E40, E43, E50, NK43, NK48, NK52, NK60, NKD43, NKD48, NKD52, NKD60, UNI43R, UNI43RD, UNI48R, UNI48RD, UNI53R, UNI53RD		



1

<b>GEV No.</b>	512127	<b>Ref. No.</b>	25007
<b>description</b>	nut for drain assembly thread 1½" ED ø 69mm		
<b>For models:</b>	CM43, CM48, CM52, CM60, CMD43, CMD48, CMD52, CMD60, E36, E40, E43, E50, ED600-95, ED630-90, ED650E, ED650E-90, ED650S, ED650S-90, ED700, ED700-90, ED900, ED900-90, EDI5, K80F, K80G, LO122, LO60, LO61, LO78, NK43, NK48, NK52, NK60, NKD43, NKD48, NKD52, NKD60, UNI43R, UNI43RD, UNI48R, UNI48RD, UNI53R, UNI53RD		



1

<b>GEV No.</b>	512190	<b>Ref. No.</b>	25078
<b>description</b>	wash arm L 290mm nozzles 1 mounting ø 30mm mounting pos. upper		
<b>For models:</b>	CM43, CMD43, E36, E40, E43, NK43, NKD43, UNI43R, UNI43RD		



1

<b>GEV No.</b>	512170	<b>Ref. No.</b>	25073
<b>description</b>	wash jet		
<b>For models:</b>	CM43, CM48, CMD43, CMD48, E36, E40, E43, NK43, NK48, NKD43, NKD48, UNI43R, UNI43RD, UNI48R, UNI48RD		



1

<b>GEV No.</b>	512219	<b>Ref. No.</b>	25074
<b>description</b>	wash jet		
<b>For models:</b>	CM52, CM60, CMD52, CMD60, E50, NK52, NK60, NKD52, NKD60, UNI53R, UNI53RD		



1

<b>GEV No.</b>	512220	<b>Ref. No.</b>	25075
<b>description</b>	wash jet		
<b>For models:</b>	CM52, CM60, CMD52, CMD60, E50, NK52, NK60, NKD52, NKD60, UNI53R, UNI53RD		



Зип Общепит

vsezip.ru

812)987-08-81



1

<b>GEV No.</b>	510728	<b>Ref. No.</b>	33795
<b>description</b>	wash arm L 250mm mounting pos. lower nozzles 4 mounting ø 25mm suitable for B23-27-10-11		
<b>For models:</b>	CDN3, CDN4, CR43, CR43D, CR48, CR48D, SPR36, SPR36D, SPR41, SPR41D		
<b>spare parts for</b>	510728		
	<b>GEV No.</b>	510731	<b>Ref. No.</b>
			—
	end cap for wash arm		
	<b>GEV No.</b>	560140	<b>Ref. No.</b>
			30194
	hexagonal nut thread M4 H 4.8mm SS WS 7 Qty 20 pcs DIN/ISO DIN 985 self-locking		



1

<b>GEV No.</b>	510732	<b>Ref. No.</b>	33800
<b>description</b>	wash arm L 280mm mounting pos. upper nozzles 2 suitable for B20-B10t		
<b>For models:</b>	CDN3, CR43, CR43D, CR48, SPR36, SPR36D, SPR41		



1

<b>GEV No.</b>	510280	<b>Ref. No.</b>	33805
<b>description</b>	wash arm L 282mm mounting pos. upper nozzles 2 lateral Hmm suitable for B23-12t		
<b>For models:</b>	CDN4, CR48, CR48D, SPR41, SPR41D		



1

<b>GEV No.</b>	510761	<b>Ref. No.</b>	25263
<b>description</b>	flat gasket rubber D1 ø 38mm D2 ø 25mm thickness 2mm Qty 1 pcs		
<b>For models:</b>	60BT, 60BT-3, 60EBT, APS43, APS48, APS48B, APS53, APS60, APSE43, APSE48, APSE53, APSE60, BPN48, BPS43, BPS52, C3, C35, C35E, C4, C43, C43-2, C43ALTA, C43D, C43DE, C43E, C46DE, C46E, C48, C48-2, C48D, C48D-2, C48DDL, C48DL, C48E, C53, C53D, C53DE, C53E, C6, C60, C60D, C60DE, C60E, C68DE, C68E, C68EBT, C6D, C6DE, C6E, C6EBT...(Other models you can see in the webshop)		







Зип Общепит

vsezip.ru

+7(812)987-08-81

			
1			
<b>GEV No.</b>	510734	<b>Ref. No.</b>	33799
<b>description</b>	nozzle for wash arm suitable for B23-10-11-12		
<b>For models:</b>	CDN3, CDN4, CR43, CR43D, CR48, CR48D, SPR36, SPR36D, SPR41, SPR41D		

			
1			
<b>GEV No.</b>	510736	<b>Ref. No.</b>	33802
<b>description</b>	nozzle for wash arm suitable for B23-10-12		
<b>For models:</b>	CDN3, CDN4, CR43, CR43D, CR48, CR48D, SPR36, SPR36D, SPR41, SPR41D		

			
1			
<b>GEV No.</b>	510735	<b>Ref. No.</b>	33801
<b>description</b>	nozzle holder for wash arm		
<b>For models:</b>	CDN3, CDN4, CR43, CR43D, CR48, CR48D, SPR36, SPR36D, SPR41, SPR41D		

			
1			
<b>GEV No.</b>	511200	<b>Ref. No.</b>	15242
<b>description</b>	nut thread 1" H 6mm brass WS 45 Qty 1 pcs		
<b>For models:</b>	CDN3, CDN4, CM52, CM60, CMD52, CMD60, CR43, CR43D, CR48, CR48D, K80F, K80G, M60, NK52, NK60, NKD52, NKD60, SPR36, SPR36D, SPR41, SPR41D, T5-80, T6-80, UNI43R, UNI43RD, UNI48R, UNI48RD, UNI53R, UNI53RD		



			
1			
<b>GEV No.</b>	507309	<b>Ref. No.</b>	33798
<b>description</b>	O-ring EPDM thickness 2.62mm ID ø 17.13mm Qty 1 pcs		
<b>For models:</b>	CDN3, CDN4, CR43, CR43D, CR48, CR48D, SPR36, SPR36D, SPR41, SPR41D		

			
1			
<b>GEV No.</b>	510737	<b>Ref. No.</b>	33789
<b>description</b>	rinse arm L 205mm mounting pos. upper nozzles 3 mounting ø 12mm complete with nozzle		
<b>For models:</b>	CDN3, CDN4, CR43, CR43D, CR48, CR48D, SPR36, SPR36D, SPR41, SPR41D		

			
1			
<b>GEV No.</b>	512193	<b>Ref. No.</b>	33794
<b>description</b>	rinse arm L 240mm mounting ø 12mm nozzles 3 suitable for HOONVED mounting pos. lower		
<b>For models:</b>	CDN3, CDN4, CR43, CR43D, CR48, CR48D, SPR36, SPR36D, SPR41, SPR41D		

			
1			
<b>GEV No.</b>	510323	<b>Ref. No.</b>	160734 33793
<b>description</b>	end cap for rinse arm		
<b>For models:</b>	C35, C35E, C43, C43-2, C43ALTA, C43D, C43DE, C43E, C46DE, C46E, C48, C48-2, C48D, C48D-2, C48DDL, C48DL, C48E, C6, C6D, C6DE, C6E, C6EBT, CDN3, CDN4, CR43, CR43D, CR48, CR48D, GS-X1011, GS-X1011-2, GS-X1011-WEH, GS-X1011-WEH-2, RSP40, RSP40A, SP35, SP35-2, SP35ALTA, SP35D, SP35DE, SP35E, SP40, SP40-2, SP40D, SP40D-2, SP40DDL, SP40DE, SP40DL, SP40E, SP5, SP5D...(Other models you can see in the webshop)		

			
1			
<b>GEV No.</b>	510885	<b>Ref. No.</b>	33784
<b>description</b>	gasket suitable for COMENDA equiv. no. 200464 L 60mm W 30mm		
<b>For models:</b>	CDN3, CDN4, CR43, CR43D, CR48, CR48D, SPR36, SPR36D, SPR41, SPR41D		

			
1			
<b>GEV No.</b>	510327	<b>Ref. No.</b>	170946 33791 H170946
<b>description</b>	nozzle for rinse arm		
<b>For models:</b>	C35, C35E, C43, C43-2, C43ALTA, C43D, C43DE, C43E, C46DE, C46E, C48, C48-2, C48D, C48D-2, C48DDL, C48DL, C48E, C6, C6D, C6DE, C6E, C6EBT, CDN3, CDN4, CR43, CR43D, CR48, CR48D, GS-X1011, GS-X1011-2, GS-X1011-WEH, GS-X1011-WEH-2, RSP40, RSP40A, SP35, SP35-2, SP35ALTA, SP35D, SP35DE, SP35E, SP40, SP40-2, SP40D, SP40D-2, SP40DDL, SP40DE, SP40DL, SP40E, SP5, SP5D...(Other models you can see in the webshop)		
<b>accessories for</b>	510327		
	<b>GEV No.</b>	510902	<b>Ref. No.</b> 33790
	O-ring EPDM thickness 2mm ID ø 9.5mm Qty 1 pcs		



Зип Общепит

vsezip.ru

812)9813897

1			
<b>GEV No.</b>	528583	<b>Ref. No.</b>	33792
<b>description</b>	O-ring EPDM thickness 2.62mm ID ø 9.13mm Qty 1 pcs		
<b>For models:</b>	C35, C35E, C43, C43-2, C43ALTA, C43D, C43DE, C43E, C46DE, C46E, C48, C48-2, C48D, C48D-2, C48DDL, C48DL, C48E, C6, C6D, C6DE, C6E, C6EBT, CDN3, CDN4, CR43, CR43D, CR48, CR48D, GS-X1011, GS-X1011-2, GS-X1011-WEH, GS-X1011-WEH-2, RSP40, RSP40A, SP35, SP35-2, SP35ALTA, SP35D, SP35DE, SP35E, SP40, SP40-2, SP40D, SP40D-2, SP40DDL, SP40DE, SP40DL, SP40E, SP5, SP5D...(Other models you can see in the webshop)		

1			
<b>GEV No.</b>	510902	<b>Ref. No.</b>	33790
<b>description</b>	O-ring EPDM thickness 2mm ID ø 9.5mm Qty 1 pcs		
<b>For models:</b>	C35, C35E, C43, C43-2, C43ALTA, C43D, C43DE, C43E, C46DE, C46E, C48, C48-2, C48D, C48D-2, C48DDL, C48DL, C48E, C6, C6D, C6DE, C6E, C6EBT, C81, C81E, C81EBT, C90, C90DE, C90E, C90EBT, CDN3, CDN4, CR43, CR43D, CR48, CR48D, EDI13, EDI13ALTA, EDI6, EDI8, GS-X1011, GS-X1011-2, GS-X1011-WEH, GS-X1011-WEH-2, LO134, LO134ALTA, LO50, LO50E, LO67, LO83, RLO200...(Other models you can see in the webshop)		

1				
<b>GEV No.</b>	512189	<b>Ref. No.</b>	430176	
<b>description</b>	rinse arm L 485mm mounting pos. upper/lower nozzles 4 mounting ø 25.4mm complete with nozzle suitable for COMENDA, HOONVED			
<b>For models:</b>	AC101, AC151, AC181, AC201, AC241, AC91, EDT100, EDT140, EDT170, EDT200, EDT230, EDT85			
<b>spare parts for</b>	512189			
	<b>GEV No.</b>	511220	<b>Ref. No.</b>	380323 H380323
	nozzle for rinse arm			
	<b>GEV No.</b>	530293	<b>Ref. No.</b>	H200809
	O-ring EPDM thickness 1.78mm ID ø 8.73mm Qty 1 pcs			

1			
<b>GEV No.</b>	510277	<b>Ref. No.</b>	430136 H430136
<b>description</b>	rinse arm L 485mm mounting pos. upper/lower nozzles 6 mounting ø 25mm complete with nozzle		

1			
<b>GEV No.</b>	511220	<b>Ref. No.</b>	380323 H380323
<b>description</b>	nozzle for rinse arm		
<b>For models:</b>	AC101, AC151, AC181, AC201, AC241, AC91, EDT100, EDT140, EDT170, EDT200, EDT230, EDT85, HT10J, HT150, HTP195, HTP205, HTP220, TR100, TR90, TR-E100, TR-E150		

1			
<b>GEV No.</b>	530293	<b>Ref. No.</b>	H200809
<b>description</b>	O-ring EPDM thickness 1.78mm ID ø 8.73mm Qty 1 pcs		
<b>For models:</b>	EDI13, EDI13-2, EDI13ALTA, EDI13ALTA-2, EDI13ALTABT, EDI13BT, EDI4, EDI6, EDI6-2, EDI6BT, EDI8, EDI8-2, EDI8BT, EDT100, EDT140, EDT170, EDT200, EDT230, EDT85, LO134, LO134-2, LO134ALTA, LO134ALTA-2, LO56, LO67, LO67-2, LO83, LO83-2, RLO200, RLO300, RLO400, TR100, TR140, TR170, TR200, TR230, TR90, TR-E100, TR-E150, TR-E170, TR-E200, TR-E230, TR-E90		

1			
<b>GEV No.</b>	512084	<b>Ref. No.</b>	31313
<b>description</b>	opposite support for rinse jet		
<b>For models:</b>	APS43, APS48, APS48B, APS53, APS60, APSE43, APSE48, APSE53, APSE60, C3, C4, C53, C53D, C60, C60D, CM48, CM52, CMD43, CMD52, DP35, DP35D, DP40, DP40D, DP45, DP45D, DP50, DP50D, ED600-95, ED630-90, ED700-90, ED900-90, EDI5, FW35, FW40, FW40B, FW45, FW50, INDY43F, INDY48F, INDY53F, INDY60F, LO122, LO60, LO61, LO78, SP45, SP45D, SP50, SP50-400V, SP50-440V...(Other models you can see in the webshop)		

1			
<b>GEV No.</b>	510196	<b>Ref. No.</b>	25069
<b>description</b>	rinse jet		

1			
<b>GEV No.</b>	510197	<b>Ref. No.</b>	25070
<b>description</b>	rinse jet		
<b>For models:</b>	E40-2F, M60, T3-80, T4-80, T5-80, T6-80		



Зип Общепит

vsezip.ru

+7(812)987-08-81



1

<b>GEV No.</b>	512196	<b>Ref. No.</b>	170954
<b>description</b>	rinse jet H 18.5mm		
<b>For models:</b>	AC101, AC151, AC91, EDT100, EDT140, EDT85, HG2LR, HGLR		



1

<b>GEV No.</b>	517627	<b>Ref. No.</b>	31384
<b>description</b>	rinse jet H 24.5mm		
<b>For models:</b>	BPS43, BPS52		



1

<b>GEV No.</b>	512158	<b>Ref. No.</b>	29358
<b>description</b>	rinse jet holder L 70mm nozzles 1 mounting ø 12mm mounting pos. lower		
<b>For models:</b>	APS60, APSE60, ED650E, ED650S, FW50, K80F		



1

<b>GEV No.</b>	512083	<b>Ref. No.</b>	31314
<b>description</b>	rinse jet holder mounting pos. upper		
<b>For models:</b>	APS43, APS48, APS48B, APS53, APS60, APSE43, APSE48, APSE53, APSE60, C3, C4, C53, C53D, C60, C60D, CM48, CM52, CMD43, CMD52, DP35, DP35D, DP40, DP40D, DP45, DP45D, DP50, DP50D, ED600-95, ED630-90, ED700-90, ED900-90, EDI5, FW35, FW40, FW40B, FW45, FW50, INDY43F, INDY48F, INDY53F, INDY60F, LO122, LO60, LO61, LO78, SP45, SP45D, SP50, SP50-400V, SP50-440V...(Other models you can see in the webshop)		



1

<b>GEV No.</b>	510198	<b>Ref. No.</b>	25072
<b>description</b>	swirl hole ø 2.5mm H 4.5mm ø 18.5mm		
<b>For models:</b>	ED700, ED900, K80G, M60, T3-80, T5-80, T6-80		



1

<b>GEV No.</b>	517640	<b>Ref. No.</b>	37722
<b>description</b>	wash jet H 16mm ø 12mm		
<b>For models:</b>	AP43E, AP48E, AP53E, AP60E, FW35E, FW40E		



1

<b>GEV No.</b>	517624	<b>Ref. No.</b>	25135
<b>description</b>	wash jet thread 1/2" IT H 21mm ø 6mm		
<b>For models:</b>	ED700, ED900, K80G		



1

<b>GEV No.</b>	512324	<b>Ref. No.</b>	H190224
<b>description</b>	opposite support mounting pos. lower for wash arm support		
<b>For models:</b>	DP35-2, DP35D-2, DP40-2, DP40D-2, DP40D-rib2, DP40-rib2, GS-X1021-2, GS-X1021-2rib, GS-X1021-WEH-2, GS-X1021-WEH-2rib, ST-43DE, ST43E, ST48DE, ST48E, STS43-2, STS43D-2, STS48-2, STS48D-2, STS48D-rib2, STS48-rib2, TDN4-2rib		



1

<b>GEV No.</b>	512054	<b>Ref. No.</b>	32887
<b>description</b>	wash arm support		
<b>For models:</b>	C3, C4, C43, C48, DP35, DP35D, DP40, DP40D, DP45, DP45D, DP50, DP50D, GS-X1021, GS-X1021-WEH, STS43, STS43D, STS48, STS48D, STS53, STS53D, STS60, STS60D		

Зип Общепит

vsezip.ru

+7(812)987-08-81



1

<b>GEV No.</b>	512243	<b>Ref. No.</b>	32272
<b>description</b>	wash arm support for rinse arm mounting pos. upper		
<b>For models:</b>	APS60, APSE60, FW50		



1

<b>GEV No.</b>	512027	<b>Ref. No.</b>	190941 36280
<b>description</b>	wash arm support mounting pos. lower		
<b>For models:</b>	60EBT, C53DE, C53E, C60DE, C60E, DP45DE, DP45E, DP50DE, DP50E, DP50EBT, SP45DE, SP45E, SP50DE, SP50E, SP50E-400V3-50Hz-MARINE, SP50E-440V3-60Hz-MARINE, ST53DE, ST53E, ST60DE, ST60E, ST60EBT		



1

<b>GEV No.</b>	512051	<b>Ref. No.</b>	21035
<b>description</b>	wash arm support mounting pos. lower		
<b>For models:</b>	INDY43F, INDY48F, INDY53F, INDY60F, UNI43C, UNI48C, UNI48CD, UNI53C, UNI60C		



1

<b>GEV No.</b>	512057	<b>Ref. No.</b>	32350
<b>description</b>	wash arm support mounting pos. lower		
<b>For models:</b>	60BT, 60BT-3, APS43, APS48, APS48B, APS53, APS60, APSE43, APSE48, APSE53, APSE60, C3, C35, C4, C43, C43ALTA, C43D, C48, C48D, C48DDL, C48DL, C53, C53D, C60, C60D, DP35, DP35D, DP40, DP40D, DP45, DP45D, DP50, DP50D, DP50D-115V, FW35, FW40, FW40B, FW45, FW50, GS-X1011, GS-X1011-WEH, GS-X1021, GS-X1021-WEH, RSP50, RSP50A, SD5BT, SP35, SP35ALTA, SP35D, SP40...(Other models you can see in the webshop)		
<b>accessories for</b>	512057		



1

<b>GEV No.</b>	512245	<b>Ref. No.</b>	33544
<b>description</b>	hose connector thread 1/2" grommet ø 30mm ID ø 16mm grommet length 28mm total length 35mm ED ø 31.5mm		



1

<b>GEV No.</b>	512142	<b>Ref. No.</b>	33700
<b>description</b>	wash arm support mounting pos. lower		
<b>For models:</b>	C35, C43, C43ALTA, C43D, C48, C48D, C48DDL, C48DL, GS-X1011, GS-X1011-WEH, SP35, SP35ALTA, SP35D, SP40, SP40D, SP40DDL, SP40DL, SPB35		



1

<b>GEV No.</b>	512247	<b>Ref. No.</b>	32981 36431
<b>description</b>	wash arm support mounting pos. lower		
<b>For models:</b>	APS43, APS48, APS48B, APS53, APS60, APSE43, APSE48, APSE53, C90, FW35, FW40, FW40B, FW45, FW50, LO50, US-X501		



1

<b>GEV No.</b>	512249	<b>Ref. No.</b>	32357
<b>description</b>	wash arm support mounting pos. lower		
<b>For models:</b>	APS60, APSE60, FW50		



1

<b>GEV No.</b>	512268	<b>Ref. No.</b>	H191083
<b>description</b>	wash arm support mounting pos. lower		
<b>For models:</b>	C35E, C43-2, C43DE, C43E, C46DE, C46E, C48-2, C48D-2, C48E, DP35-2, DP35D-2, DP40-2, DP40D-2, DP40D-rib2, DP40-rib2, GS-X1011-2, GS-X1011-WEH-2, GS-X1021-2, GS-X1021-2rib, GS-X1021-WEH-2, GS-X1021-WEH-2rib, RSP40, RSP40A, SP35-2, SP35DE, SP35E, SP40-2, SP40D-2, SP40DE, SP40E, ST43DE, ST43E, ST48DE, ST48E, STS43-2, STS43D-2, STS48-2, STS48D-2, STS48D-rib2, STS48-rib2, TDN4-2rib		



1

<b>GEV No.</b>	512269	<b>Ref. No.</b>	H190223
<b>description</b>	wash arm support mounting pos. lower		
<b>For models:</b>	C35E, C43-2, C43DE, C43E, C46DE, C46E, C48-2, C48D-2, C48E, GS-X1011-2, GS-X1011-WEH-2, RSP40, RSP40A, SP35-2, SP35DE, SP35E, SP40-2, SP40D-2, SP40DE, SP40E, SPB35E		





1

<b>GEV No.</b>	512711	<b>Ref. No.</b>	35370
<b>description</b>	wash arm support mounting pos. lower		
<b>For models:</b>	C35, GS-X1011, GS-X1011-WEH, SPB35		





Зип Общепит  
vsezip.ru  
+7(812)987-08-81

			
1			
<b>GEV No.</b>	512294	<b>Ref. No.</b>	16082
<b>description</b>	wash arm support mounting pos. lower D1 ø 46mm D2 ø 49mm D3 ø 60mm H 178mm		
<b>For models:</b>	M60, T5-80		

			
1			
<b>GEV No.</b>	511973	<b>Ref. No.</b>	38714
<b>description</b>	wash arm support mounting pos. lower ED ø 55.5mm L 110mm SS ID ø 50.7mm seat ø 20mm		

			
1			
<b>GEV No.</b>	524464	<b>Ref. No.</b>	191102 36279
<b>description</b>	wash arm support mounting pos. lower ø 59mm H 88mm ID ø 33mm		
<b>For models:</b>	60EBT, C53DE, C53E, C60DE, C60E, DP45DE, DP45E, DP50DE, DP50E, DP50EBT, SP45DE, SP45E, SP50DE, SP50E, SP50E-400V3-50Hz-MARINE, SP50E-440V3-60Hz-MARINE, ST53DE, ST53E, ST60DE, ST60E, ST60EBT		

			
1			
<b>GEV No.</b>	511268	<b>Ref. No.</b>	33471 510503 H510503
<b>description</b>	wash arm support mounting pos. upper		
<b>For models:</b>	C98, CA120, CA55, CA90, CAP7, CAP7E, ED550, ED650E, ED650S, LO62, RCA1100, RCA1200, RCA1200i, SO55, SO55-400V3-50Hz-MARINE, SO55-440V3-60Hz-MARINE, SO55E		

			
1			
<b>GEV No.</b>	512044	<b>Ref. No.</b>	31448
<b>description</b>	wash arm support mounting pos. upper		
<b>For models:</b>	DP35, DP35D, INDY43F, INDY48F, STS43, STS43D, UNI43C, UNI48C, UNI48CD		

			
1			
<b>GEV No.</b>	512049	<b>Ref. No.</b>	21906
<b>description</b>	wash arm support mounting pos. upper		

			
1			
<b>GEV No.</b>	512274	<b>Ref. No.</b>	34314
<b>description</b>	wash arm support mounting pos. upper		
<b>For models:</b>	60BT, 60BT-3, C53, C53D, C60, C60D, DP35, DP35D, DP40, DP40D, DP45, DP45D, DP50, DP50D, DP50D-115V, GS-X1021, GS-X1021-WEH, RSP50, RSP50A, SD5BT, SP45, SP45D, SP50, SP50-400V, SP50-440V, SP50D, STS43, STS43D, STS48, STS48D, STS53, STS53D, STS60, STS60D, TN-TDN5, TN-TDN6, VS-X313, VS-X313-LP-DOS, VS-X515, VS-X515-LP-DOS		

			
1			
<b>GEV No.</b>	512308	<b>Ref. No.</b>	31470
<b>description</b>	wash arm support mounting pos. upper		
<b>For models:</b>	C53, C53D, C60, C60D, DP40, DP40D, DP45, DP45D, DP50, DP50D, INDY53F, INDY60F, SP45, SP45D, SP50, SP50-400V, SP50-440V, SP50D, STS48, STS48D, STS53, STS53D, STS60, STS60D, UNI53C, UNI60C		

			
1			
<b>GEV No.</b>	512323	<b>Ref. No.</b>	H190222
<b>description</b>	wash arm support mounting pos. upper		
<b>For models:</b>	DP35-2, DP35D-2, DP40-2, DP40D-2, DP40D-rib2, DP40-rib2, GS-X1021-2, GS-X1021-2rib, GS-X1021-WEH-2, GS-X1021-WEH-2rib, ST-43DE, ST43E, ST48DE, ST48E, STS43-2, STS43D-2, STS48-2, STS48D-2, STS48D-rib2, STS48-rib2, TDN4-2rib		

			
1			
<b>GEV No.</b>	511954	<b>Ref. No.</b>	38715
<b>description</b>	wash arm support mounting pos. upper ED ø 68mm L 110mm SS seat ø 20mm		

			
1			
<b>GEV No.</b>	512489	<b>Ref. No.</b>	190944
<b>description</b>	wash arm support mounting pos. upper thread M6		

Зип Общепит

vsezip.ru

+7(812)98708-81



<b>GEV No.</b>	511179	<b>Ref. No.</b>	190215 35F11
<b>description</b>	wash arm support mounting pos. upper thread M8 shaft L 55mm		
<b>For models:</b>	C6, C6D, C6DE, C6E, C6EBT, SP5, SP5D, SP5DE, SP5E		



<b>GEV No.</b>	510319	<b>Ref. No.</b>	33470 510238 H510238
<b>description</b>	wash arm support mounting pos. upper/lower		
<b>For models:</b>	C81, C81E, C81EBT, C90, C90DE, C90E, C90EBT, C98, CA120, CA55, CA90, CAP7, CAP7E, ED550, ED650E, ED650S, LO50, LO50E, LO62, RCA1100, RCA1200, RCA1200i, RLO50, SMW15, SMW15E, SO55, SO55-400V3-50Hz-MARINE, SO55-440V3-60Hz-MARINE, SO55E, SP81, SP81E, US-X501		



<b>GEV No.</b>	510448	<b>Ref. No.</b>	H190209
<b>description</b>	wash arm support with rinse arm shaft mounting pos. upper		
<b>For models:</b>	C35E, C43-2, C43DE, C43E, C46DE, C46E, C48-2, C48D-2, C48E, GS-X1011-2, GS-X1011-WEH-2, RSP40, RSP40A, SP35-2, SP35DE, SP35E, SP40-2, SP40D-2, SP40DE, SP40E, SPB35E		



<b>GEV No.</b>	510114	<b>Ref. No.</b>	190227 H190227
<b>description</b>	wash arm support with rinse arm shaft mounting pos. upper/lower ø 74mm H 142mm		
<b>For models:</b>	C90DE2, C90E2, C90EBT2, CAP10, CAP10BT, CAP10DE, CAP12, CAP12DE, CAP12EBT, CAP15EBT, CAP7E, EDI4, HD40ALTABT, HD40BT, LO56, SO100, SO100-400V3-50Hz-MARINE, SO100-440V3-60Hz-MARINE, SO120		

## rinse arm shafts



<b>GEV No.</b>	510318	<b>Ref. No.</b>	33460 340499 H340499
<b>description</b>	rinse arm shaft		
<b>For models:</b>	C98, CA120, CA55, CA90, CAP7, CAP7E, ED550, ED650E, ED650S, LO62, RCA1100, RCA1200, RCA1200i, SO55, SO55-400V3-50Hz-MARINE, SO55-440V3-60Hz-MARINE, SO55E		



<b>GEV No.</b>	512066	<b>Ref. No.</b>	18825
<b>description</b>	rinse arm shaft		
<b>For models:</b>	C53, C53D, C60, C60D, DP45, DP45D, DP50, DP50D, SP45, SP45D, SP50, SP50-400V, SP50-440V, SP50D, STS43, STS43D, STS48, STS48D, STS53, STS53D, STS60, STS60D		



<b>GEV No.</b>	512210	<b>Ref. No.</b>	34997
<b>description</b>	rinse arm shaft		
<b>For models:</b>	C81, C81E, C81EBT, C90, C90DE, C90E, C90EBT, DP35-2, DP35D-2, DP40-2, DP40D-2, DP40D-rib2, DP40-rib2, EDI13, EDI13ALTA, EDI6, EDI8, GS-X1021-2, GS-X1021-2rib, GS-X1021-WEH-2, GS-X1021-WEH-2rib, LO134, LO134ALTA, LO50, LO50E, LO67, LO83, RLO200, RLO300, RLO400, RLO50, SMW15, SMW15E, SP81, SP81E, ST43DE, ST43E, ST48DE, ST48E, ST48EBT, STS43-2, STS43D-2, STS48-2, STS48D-2, STS48D-rib2, STS48-rib2, TDN4-2rib, US-X501		



<b>GEV No.</b>	512238	<b>Ref. No.</b>	17917 34351
<b>description</b>	rinse arm shaft		
<b>For models:</b>	APS43, APS48, APS48B, APS53, APS60, APSE43, APSE48, APSE53, APSE60, C3, C4, C53, C53D, C60, C60D, DP35, DP35D, DP40, DP40D, DP45, DP45D, DP50, DP50D, FW35, FW40, FW40B, FW45, FW50, SP45, SP45D, SP50, SP50-400V, SP50-440V, SP50D, STS43, STS43D, STS48, STS48D, STS53, STS53D, STS60, STS60D		



<b>GEV No.</b>	512251	<b>Ref. No.</b>	251200 32403
<b>description</b>	rinse arm shaft		
<b>For models:</b>	APS43, APS48, APS48B, APS53, APS60, APSE43, APSE48, APSE53, APSE60, EDI13ALTABT, EDI13BT, EDI6BT, EDI8BT, FW35, FW40, FW40B, FW45, FW50, HD130BT, HG2LR, HGLR		



<b>GEV No.</b>	512261	<b>Ref. No.</b>	33699
<b>description</b>	rinse arm shaft		
<b>For models:</b>	C35, C43, C43ALTA, C43D, C48, C48D, C48DDL, C48DL, GS-X1011, GS-X1011-WEH, SP35, SP35ALTA, SP35D, SP40, SP40D, SP40DDL, SP40DL, SPB35		





Зип Общепит

vsezip.ru

+7(812)987-08-81

			
1			
<b>GEV No.</b>	512292	<b>Ref. No.</b>	15243
<b>description</b>	rinse arm shaft mounting pos. lower		
<b>For models:</b>	T3-80, T4-80, T6-80		

			
1			
<b>GEV No.</b>	512255	<b>Ref. No.</b>	34375
<b>description</b>	rinse arm shaft mounting pos. upper		
<b>For models:</b>	C35, C43, C43D, C48, C48D, SP35, SP35D, SP40, SP40D, SPB35		

			
1			
<b>GEV No.</b>	512018	<b>Ref. No.</b>	34384
<b>description</b>	rinse arm shaft mounting pos. upper/lower ø 16mm thread M10L L 38mm		
<b>For models:</b>	60BT, 60BT-3, C53, C53D, C60, C60D, C81, C90, DP35, DP35D, DP40, DP40D, DP45, DP45D, DP50, DP50D, DP50D-115V, GS-X1021, GS-X1021-WEH, LOS0, RSP50, RSP50A, SD5BT, SP45, SP45D, SP50, SP50-400V, SP50-440V, SP50D, SP81, STS43, STS43D, STS48, STS48D, STS53, STS53D, STS60, STS60D, TN-TDN5, TN-TDN6, US-X501, VS-X313, VS-X313-LP-DOS, VS-X515, VS-X515-LP-DOS		

knobs

producer-specific knobs

HOONVED

			
1			
<b>GEV No.</b>	111397	<b>Ref. No.</b>	25097 26668 26669
<b>description</b>	knob ø 43.5mm shaft ø 6.5mm brown L 32mm		
<b>For models:</b>	CM43, CM48, CM60, CMD43, CMD48, CMD52, CMD60, K80F, K80G		

			
1			
<b>GEV No.</b>	110093	<b>Ref. No.</b>	450323 H450323
<b>description</b>	knob switch zero mark t.max.°C ø 42mm shaft ø 5x5mm shaft flat black		
<b>For models:</b>	C98, EDI5, HG2LR, HGLR, LO61, LO62		

			
<b>GEV No.</b>	110062	<b>Ref. No.</b>	H180111
<b>description</b>	knob switch zero mark t.max.°C ø 45mm shaft ø 5x5mm shaft flat black		
<b>For models:</b>	EDT100, EDT140, EDT170, EDT200, EDT230, EDT85, TR100, TR140, TR170, TR200, TR90, TR-E100, TR-E150, TR-E170, TR-E200, TR-E230, TR-E90		

accessories

button springs

			
1			
<b>GEV No.</b>	111497	<b>Ref. No.</b>	25828
<b>description</b>	knob spring L 17mm W 6.3mm H 8.3mm thickness 0.6mm Qty 1 pcs		
<b>For models:</b>	CM43, CM48, CM52, CM60, CMD43, CMD48, CMD52, CMD60, K80F, K80G		

rosettes

			
1			
<b>GEV No.</b>	110105	<b>Ref. No.</b>	191040 H191040
<b>description</b>	rosette knob ø 42mm ø 56mm zero mark		
<b>For models:</b>	60EBT, AC101, AC151, AC181, AC201, AC241, AC91, C35E, C43DE, C43E, C46DE, C46E, C53DE, C53E, C60DE, C60E, C68DE, C68E, C68EBT, C6DE, C6E, C6EBT, C90DE2, C90E2, C90EBT2, CA55, CAP7, CAP7E, DP45DE, DP45E, DP50DE, DP50E, DP50EBT, ED550, EDT100, EDT140, EDT170, EDT200, EDT230, EDT85, HD130BT, HD40ALTABT, HD40BT, HD60BT, HD80BT, HT100, HT150, RCA1100, RCA1200, RCA1200i... (Other models you can see in the webshop)		

handles and hand wheels

handle rails

handle rails

			
1			
<b>GEV No.</b>	510454	<b>Ref. No.</b>	170806 H170806
<b>description</b>	handle rail L 480mm W 52mm H 20mm Qty 1 pcs		

Зип-Общепит  
equipment feet with stem

mechanical components, equipment accessories

locks

snap locks

producer-specific

HOONVED



1			
<b>GEV No.</b>	692100	<b>Ref. No.</b>	180508 37198
<b>description</b>	snap lock L 36mm ø 17mm		
<b>For models:</b>	60EBT, C60DE, C60E, C6DE, C6E, C6EBT, SP50DE, SP50E		

miscellaneous



1			
<b>GEV No.</b>	701044	<b>Ref. No.</b>	341016 H341016
<b>description</b>	angle piece for catch hook L 54mm W 27mm H 8.5mm		
<b>For models:</b>	AC101, AC151, AC181, AC201, AC241, AC91, EDT100, EDT140, EDT170, EDT200, EDT230, EDT85, TR100, TR140, TR170, TR200, TR230, TR90, TR-E100, TR-E150, TR-E170, TR-E200, TR-E230, TR-E90		

equipment feet and end caps

equipment feet

with fixing plate



1			
<b>GEV No.</b>	504350	<b>Ref. No.</b>	602222 H620222
<b>description</b>	equipment foot for dishwasher L 135-230mm		
<b>For models:</b>	EDT100, EDT140, EDT170, EDT200, EDT230, EDT85, TR100, TR140, TR170, TR200, TR230, TR90		

screw-in feet



1			
<b>GEV No.</b>	691652	<b>Ref. No.</b>	25209
<b>description</b>	equipment foot thread M10 thread L 25mm H 8mm ø 25mm overall height 33mm WS 25 Qty 1 pcs		
<b>For models:</b>	60BT, 60BT-3, 60EBT, AP43E, AP48E, AP53E, AP60E, APS43, APS48, APS48B, APS53, APS60, APSE43, APSE48, APSE53, APSE60, C3, C35, C35E, C4, C43, C43-2, C43ALTA, C43D, C43DE, C43E, C46DE, C46E, C48, C48-2, C48D, C48D-2, C48DDL, C48DL, C48E, C53, C53D, C53DE, C53E, C6, C60, C60D, C60DE, C60E, C68DE, C68E, C68EBT, C6D, C6DE, C6E... (Other models you can see in the webshop)		

1			
<b>GEV No.</b>	701046	<b>Ref. No.</b>	210404 H210404
<b>description</b>	equipment foot push-in ø 35mm H 5mm mounting ø 9.5mm overall height 19mm rubber Qty 1 pcs		
<b>For models:</b>	AC101, AC151, AC181, AC201, AC241, AC91, EDT100, EDT140, EDT170, EDT200, EDT230, EDT85, TR100, TR140, TR170, TR200, TR230, TR90		

baskets

warewashing baskets

steel wire baskets round

mix baskets



1			
<b>GEV No.</b>	970519	<b>Ref. No.</b>	15412
<b>description</b>	mix basket ED ø 355mm H 190mm seat ø 280mm		



1			
<b>GEV No.</b>	970312	<b>Ref. No.</b>	15414
<b>description</b>	mix basket ED ø 405mm H 160mm seat ø 280mm		
<b>For models:</b>	CM48, CMD48, NK48, NKD48		

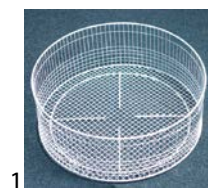

1			
<b>GEV No.</b>	970520	<b>Ref. No.</b>	15417
<b>description</b>	mix basket ED ø 455mm H 160mm seat ø 390mm		
<b>For models:</b>	CM52, CMD52, E50, NK52, NKD52		





Зип Общежит

vsezip.ru

GEV

+7(812)947-08-81

plastic baskets round



<b>GEV No.</b>	970518	<b>Ref. No.</b>	25132
<b>description</b>	mix basket ED ø 360mm H 130mm seat ø 280mm mesh type wide-meshed/plastic		
<b>For models:</b>	CM43, CM52, CMD43, E36, E40, E43, NK43, NK52, NKD43		



<b>GEV No.</b>	970319	<b>Ref. No.</b>	660703 H660703
<b>description</b>	mix basket ED ø 380mm H 160mm seat ø 365mm mesh type close-meshed/plastic		

accessories

cutlery inserts



<b>GEV No.</b>	970349	<b>Ref. No.</b>	15464
<b>description</b>	cutlery insert L 130mm W 57mm ømm H 110mm		



<b>GEV No.</b>	976017	<b>Ref. No.</b>	15465
<b>description</b>	cutlery insert L 150mm W 130mm ømm H 110mm plastic		
<b>For models:</b>	CM52, CM60, CMD52, E50, ED650E-90, ED650S, ED650S-90, K80F, K80G, M60, NK52, NK60, NKD52, T5-80, T6-80		

basket holders



<b>GEV No.</b>	971146	<b>Ref. No.</b>	37807
<b>description</b>	basket support L 585mm W 530mm for basket 500x500mm suitable for CAP7 stainless steel		
<b>For models:</b>	CAP7E, SO55E		
<b>accessories for</b>	971146		



<b>GEV No.</b>	524465	<b>Ref. No.</b>	36465
----------------	--------	-----------------	-------

roller plastic for basket holder ø 34mm

<b>GEV No.</b>	970055	<b>Ref. No.</b>	H660803
<b>description</b>	pin for dishwasher rack		



<b>GEV No.</b>	970056	<b>Ref. No.</b>	H660804
<b>description</b>	pin for dishwasher rack		



<b>GEV No.</b>	524465	<b>Ref. No.</b>	36465
<b>description</b>	roller plastic for basket holder ø 34mm		
<b>For models:</b>	CAP7, CAP7E, SO55, SO55-400V3-50Hz-MARINE, SO55-440V3-60Hz-MARINE, SO55E		

gaskets

O-rings

EPDM



<b>GEV No.</b>	510302	<b>Ref. No.</b>	29670 H200823 H200824
<b>description</b>	O-ring EPDM ID ø 12.42mm thickness 1.78mm Qty 1 pcs		
<b>For models:</b>	AP43E, AP48E, AP53E, AP60E, APS43, APS48, APS48B, APS53, APS60, APSE43, APSE48, APSE53, APSE60, BPS43, BPS52, C68DE, C68E, E40-2F, EDT100, EDT140, EDT85, FW35, FW35E, FW40, FW40B, FW40E, FW45, FW50, INDY43F, INDY48F, INDY53F, INDY60F, SP68DE, SP68E, TR100, TR140, TR90, TR-E100, TR-E150, TR-E170, TR-E200, TR-E230, TS43, TS48, UNI43C, UNI48C, UNI48CD, UNI53C, UNI60C		





<b>GEV No.</b>	504512	<b>Ref. No.</b>	25243 H200826
<b>description</b>	O-ring EPDM thickness 1.78mm ID ø 14mm Qty 1 pcs		
<b>For models:</b>	BPN48, BPS43, BPS52, E40, E40-2F, E43, E50, INDY43F, INDY48F, INDY53F, INDY60F, TS43, TS48, UNI43C, UNI48C, UNI48CD, UNI53C, UNI60C		

Зип Общепит

vsezip.ru

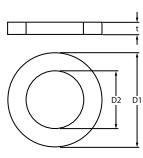
+7(812)987-08-81

			
<b>GEV No.</b>	528243	<b>Ref. No.</b>	32831
<b>description</b>	O-ring EPDM thickness 1.78mm ID $\varnothing$ 15.6mm Qty 1 pcs		
<b>For models:</b>	60BT, 60BT-3, 60EBT, AP43E, AP48E, AP53E, AP60E, APS43, APS48, APS48B, APS53, APS60, APSE43, APSE48, APSE53, APSE60, BPN48, BPS43, BPS52, C3, C35, C35E, C4, C43, C43-2, C43ALTA, C43D, C43DE, C43E, C46DE, C46E, C48, C48-2, C48D, C48D-2, C48DDL, C48DL, C48E, C53, C53D, C53DE, C53E, C6, C60, C60D, C60DE, C60E, C68DE, C68E, C68EBT...(Other models you can see in the webshop)		

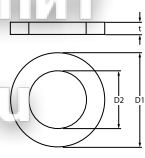
			
<b>GEV No.</b>	530293	<b>Ref. No.</b>	H200809
<b>description</b>	O-ring EPDM thickness 1.78mm ID $\varnothing$ 8.73mm Qty 1 pcs		
<b>For models:</b>	EDI13, EDI13-2, EDI13ALTA, EDI13ALTA-2, EDI13ALTABT, EDI13BT, EDI4, EDI6, EDI6-2, EDI6BT, EDI8, EDI8-2, EDI8BT, EDT100, EDT140, EDT170, EDT200, EDT230, EDT85, LO134, LO134-2, LO134ALTA, LO134ALTA-2, LO56, LO67, LO67-2, LO83, LO83-2, RLO200, RLO300, RLO400, TR100, TR140, TR170, TR200, TR230, TR90, TR-E100, TR-E150, TR-E170, TR-E200, TR-E230, TR-E90		

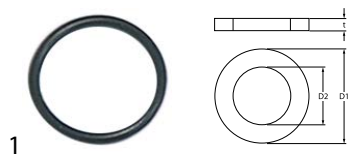
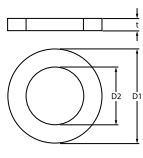
			
<b>GEV No.</b>	510322	<b>Ref. No.</b>	27050
<b>description</b>	O-ring EPDM thickness 1.78mm ID $\varnothing$ 17.17mm Qty 1 pcs		
<b>For models:</b>	C35, C35E, C43, C43-2, C43ALTA, C43D, C43DE, C43E, C46DE, C46E, C48, C48-2, C48D, C48D-2, C48DDL, C48DL, C48E, C6, C6D, C6DE, C6E, C6EBT, E40-2F, ED600-95, ED700-90, ED900-90, EDI5, GS-X1011, GS-X1011-2, GS-X1011-WEH, GS-X1011-WEH-2, INDY43F, INDY48F, INDY53F, INDY60F, K80F, LO122, LO60, LO61, LO78, RSP40, RSP40A, SP35, SP35-2, SP35ALTA, SP35D, SP35DE, SP35E, SP40, SP40-2...(Other models you can see in the webshop)		

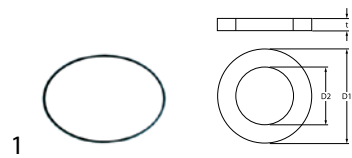
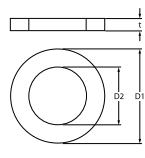
			
<b>GEV No.</b>	510556	<b>Ref. No.</b>	35497
<b>description</b>	O-ring EPDM thickness 1.78mm ID $\varnothing$ 94.97mm Qty 1 pcs pump type T110		
<b>For models:</b>	C35E, C43-2, C43DE, C43E, C46DE, C46E, C48-2, C48D-2, C48E, C68DE, C68E, C68EBT, DP35-2, DP35D-2, DP40-2, DP40D-2, DP40D-rib2, DP40-rib2, GS-X1011-2, GS-X1011-WEH-2, GS-X1021-2, GS-X1021-2rib, GS-X1021-WEH-2, GS-X1021-WEH-2rib, RSP40, RSP40A, SP35-2, SP35DE, SP35E, SP40-2, SP40D-2, SP40DE, SP40E, SP68DE, SP68E, SPB35E, ST43DE, ST43E, ST48DE, ST48E, ST48EBT, STS43-2, STS43D-2, STS48-2, STS48D-2, STS48D-rib2, STS48-rib2, TDN4-2rib		

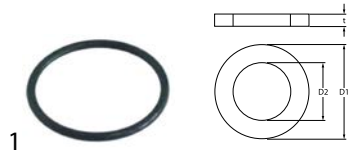
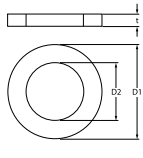
			
<b>GEV No.</b>	517045	<b>Ref. No.</b>	28224
<b>description</b>	O-ring EPDM thickness 1.78mm ID $\varnothing$ 21.95mm Qty 1 pcs		

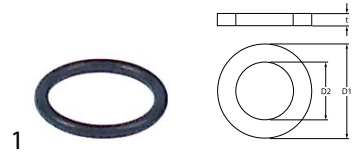
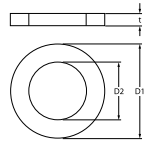
			
<b>GEV No.</b>	511237	<b>Ref. No.</b>	34360
<b>description</b>	O-ring EPDM thickness 1mm ID $\varnothing$ 7mm Qty 1 pcs		
<b>For models:</b>	60BT, 60BT-3, 60EBT, AP43E, AP48E, AP53E, AP60E, APS43, APS48, APS48B, APS53, APS60, C35, C43, C43D, C48, C48D, C53, C53D, C53DE, C53E, C60, C60D, C60DE, C60E, C68DE, C68E, C68EBT, C81, C90, CAP10, CAP10BT, CAP10DE, CAP7, CAP7E, DP35, DP35-2, DP35D, DP35D-2, DP40, DP40-2, DP40D, DP40D-2, DP40D-rib2, DP40-rib2, DP45, DP45D, DP45DE, DP45E, DP50...(Other models you can see in the webshop)		

			
<b>GEV No.</b>	510303	<b>Ref. No.</b>	31014 456030 H200818
<b>description</b>	O-ring EPDM thickness 1.78mm ID $\varnothing$ 6.75mm Qty 1 pcs		
<b>For models:</b>	APS43, APS48, APS48B, APS53, APS60, BPS43, C68DE, C68E, C81E, C81EBT, C90, C90DE, C90DE2, C90E, C90E2, C90EBT, C90EBT2, C98, CA120, CA55, CA90, ED550, ED650E, ED650S, FW35, FW40, FW40B, FW45, FW50, LO50, LO50E, LO62, RCA1100, RCA1200, RCA1200i, RLO50, SMW15, SMW15E, SP68DE, SP68E, SP81E, TS43, TS48, US-X501		

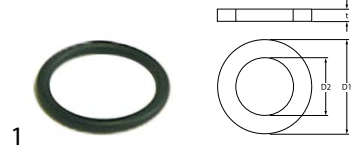
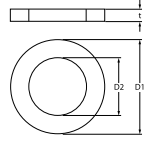
			
<b>GEV No.</b>	511191	<b>Ref. No.</b>	200813
<b>description</b>	O-ring EPDM thickness 2.21mm ID $\varnothing$ 16.36mm Qty 1 pcs		
<b>For models:</b>	C68DE, C68E, C68EBT, CAP15EBT, HD130BT, HD40ALTABT, HD40BT, HD60BT		

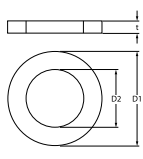
			
<b>GEV No.</b>	510177	<b>Ref. No.</b>	30475
<b>description</b>	O-ring EPDM thickness 1.78mm ID $\varnothing$ 7.66mm Qty 1 pcs		
<b>For models:</b>	BPS43, BPS52, E40-2F, INDY43F, INDY48F, INDY53F, INDY60F, TS43, TS48, UNI43C, UNI48C, UNI48CD, UNI53C, UNI60C		



Зип Общепит  
vsezip.ru  
+7(812)987-08-81

<b>GEV No.</b>	505310	<b>Ref. No.</b>	32589
<b>description</b>	O-ring EPDM thickness 2.62mm ID ø 107.62mm Qty 1 pcs		
<b>For models:</b>	APS43, APS48, APS48B, APS53, APS60, APSE43, APSE48, APSE53, APSE60, BPN48, BPS43, BPS52, FW35, FW40, FW40B, FW45, FW50		

<b>GEV No.</b>	502036	<b>Ref. No.</b>	200805 25239
<b>description</b>	O-ring EPDM thickness 2.62mm ID ø 28.25mm Qty 1 pcs		
<b>For models:</b>	60BT, 60BT-3, 60EBT, AP43E, AP48E, AP53E, AP60E, APS43, APS48, APS48B, APS53, APS60, APSE43, APSE48, APSE53, APSE60, BPN48, BPS43, BPS52, C3, C35, C35E, C4, C43, C43-2, C43ALTA, C43D, C43DE, C43E, C46DE, C46E, C48, C48-2, C48D, C48D-2, C48DDL, C48DL, C48E, C53, C53D, C53DE, C53E, C6, C60, C60D, C60DE, C60E, C68DE, C68E, C68EBT...(Other models you can see in the webshop)		

<b>GEV No.</b>	507309	<b>Ref. No.</b>	33798
<b>description</b>	O-ring EPDM thickness 2.62mm ID ø 17.13mm Qty 1 pcs		
<b>For models:</b>	CDN3, CDN4, CR43, CR43D, CR48, CR48D, SPR36, SPR36D, SPR41, SPR41D		

<b>GEV No.</b>	517104	<b>Ref. No.</b>	31639
<b>description</b>	O-ring EPDM thickness 2.62mm ID ø 31.42mm Qty 1 pcs		
<b>For models:</b>	E40-2F, INDY43F, INDY48F, INDY53F, INDY60F, TS48, UNI43C, UNI48C, UNI48CD, UNI53C, UNI60C		

<b>GEV No.</b>	516026	<b>Ref. No.</b>	25242
<b>description</b>	O-ring EPDM thickness 2.62mm ID ø 17.86mm Qty 1 pcs		

<b>GEV No.</b>	512111	<b>Ref. No.</b>	28226
<b>description</b>	O-ring EPDM thickness 2.62mm ID ø 45.69mm Qty 1 pcs		
<b>For models:</b>	60BT, 60BT-3, 60EBT, AP43E, AP48E, AP53E, AP60E, APS43, APS48, APS48B, APS53, APS60, APSE43, APSE48, APSE53, APSE60, BPN48, BPS43, BPS52, C3, C35, C35E, C4, C43, C43-2, C43ALTA, C43D, C43DE, C43E, C46DE, C46E, C48, C48-2, C48D, C48D-2, C48DDL, C48DL, C48E, C53, C53D, C53DE, C53E, C6, C60, C60D, C60DE, C60E, C68DE, C68E, C68EBT...(Other models you can see in the webshop)		

<b>GEV No.</b>	505073	<b>Ref. No.</b>	34332
<b>description</b>	O-ring EPDM thickness 2.62mm ID ø 20.63mm Qty 1 pcs		
<b>For models:</b>	60BT, 60BT-3, 60EBT, C35E, C43-2, C43ALTA, C43DE, C43E, C46DE, C46E, C48-2, C48D-2, C48DDL, C48DL, C48E, C53, C53D, C53DE, C53E, C60, C60D, C60DE, C60E, C68DE, C68E, C68EBT, C6DE, C6E, C6EBT, C81, C81E, C81EBT, C90, C90DE, C90E, C90EBT, C98, DP35, DP35-2, DP35D, DP35D-2, DP40, DP40-2, DP40D, DP40D-2, DP40D-rib2, DP40-rib2, DP45, DP45D, DP45DE...(Other models you can see in the webshop)		

<b>GEV No.</b>	512056	<b>Ref. No.</b>	32310
<b>description</b>	O-ring EPDM thickness 2.62mm ID ø 50.47mm Qty 1 pcs		
<b>For models:</b>	60BT, 60BT-3, APS43, APS48, APS48B, APS53, APS60, APSE43, APSE48, APSE53, APSE60, C3, C35, C4, C43, C43ALTA, C43D, C48, C48D, C48DDL, C48DL, C53, C53D, C60, C60D, DP35, DP35D, DP40, DP40D, DP45, DP45D, DP50, DP50D, DP50D-115V, FW35, FW40, FW40B, FW45, FW50, GS-X1011, GS-X1011-WEH, GS-X1021, GS-X1021-WEH, RSP50, RSP50A, SD58T, SP35, SP35ALTA, SP35D, SP40...(Other models you can see in the webshop)		

<b>GEV No.</b>	512071	<b>Ref. No.</b>	25238
<b>description</b>	O-ring EPDM thickness 2.62mm ID ø 22.22mm Qty 1 pcs		
<b>For models:</b>	APS43, APS48, APS53, APS60, APSE43, APSE48, APSE53, APSE60, C3, C4, E40, E40-2F, ED650S-90, INDY43F, INDY48F, INDY53F, INDY60F, UNI43C, UNI48C, UNI48CD, UNI53C, UNI60C		

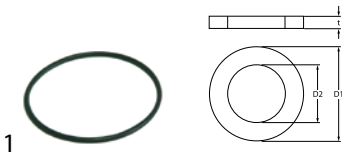

1

<b>GEV No.</b>	512114	<b>Ref. No.</b>	31557
<b>description</b>	O-ring EPDM thickness 2.62mm ID $\varnothing$ 55.25mm Qty 1 pcs		
<b>For models:</b>	E40-2F, INDY43F, INDY48F, UNI43C, UNI48C, UNI48CD, UNI53C, UNI60C		



1

<b>GEV No.</b>	528583	<b>Ref. No.</b>	33792
<b>description</b>	O-ring EPDM thickness 2.62mm ID $\varnothing$ 9.13mm Qty 1 pcs		
<b>For models:</b>	C35, C35E, C43, C43-2, C43ALTA, C43D, C43DE, C43E, C46DE, C46E, C48, C48-2, C48D, C48D-2, C48DDL, C48DL, C48E, C6, C6D, C6DE, C6E, C6EBT, CDN3, CDN4, CR43, CR43D, CR48, CR48D, GS-X1011, GS-X1011-2, GS-X1011-WEH, GS-X1011-WEH-2, RSP40, RSP40A, SP35, SP35-2, SP35ALTA, SP35D, SP35DE, SP35E, SP40, SP40-2, SP40D, SP40D-2, SP40DDL, SP40DE, SP40DL, SP40E, SP5, SP5D...(Other models you can see in the webshop)		

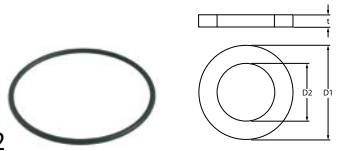

2

<b>GEV No.</b>	505311	<b>Ref. No.</b>	31386
<b>description</b>	O-ring EPDM thickness 2.62mm ID $\varnothing$ 67.95mm Qty 1 pcs		
<b>For models:</b>	BPN48, BPS43, BPS52, CAP10, CAP12, ED600-95, ED700-90, ED900-90, EDI5, LO122, LO60, LO61, LO78, SO100, SO120		



1

<b>GEV No.</b>	510901	<b>Ref. No.</b>	H200843
<b>description</b>	O-ring EPDM thickness 2mm ID $\varnothing$ 13mm Qty 1 pcs		
<b>For models:</b>	C35, C35E, C43, C43-2, C43ALTA, C43D, C43DE, C43E, C46DE, C46E, C48, C48-2, C48D, C48D-2, C48DDL, C48DL, C48E, C6, C6D, C6DE, C6E, GS-X1011, GS-X1011-2, GS-X1011-WEH, GS-X1011-WEH-2, RSP40, RSP40A, SP35, SP35-2, SP35ALTA, SP35D, SP35DE, SP35E, SP40, SP40-2, SP40D, SP40D-2, SP40DDL, SP40DE, SP40DL, SP40E, SP5, SP5D, SP5DE, SP5E, SPB35, SPB35E		

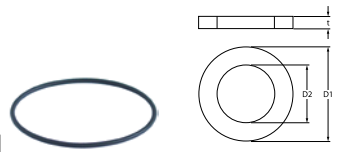

1

<b>GEV No.</b>	511395	<b>Ref. No.</b>	25245
<b>description</b>	O-ring EPDM thickness 2.62mm ID $\varnothing$ 71.12mm Qty 1 pcs		
<b>For models:</b>	APS43, APS48, APS48B, APS53, APS60, APSE43, APSE48, APSE53, APSE60, C35, C43, C43ALTA, C43D, C48, C48D, C48DDL, C48DL, C53, C53D, C60, C60D, CM43, CM48, CM52, CM60, CR43, CR43D, CR48, CR48D, DP35, DP35-2, DP35D, DP35D-2, DP40, DP40-2, DP40D, DP40D-2, DP40D-rib2, DP40-rib2, DP45, DP45D, DP50, DP50D, FW35, FW40, FW40B, FW45, FW50, GS-X1021-2, GS-X1021-2rib...(Other models you can see in the webshop)		

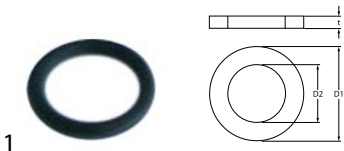

1

<b>GEV No.</b>	510902	<b>Ref. No.</b>	33790
<b>description</b>	O-ring EPDM thickness 2mm ID $\varnothing$ 9.5mm Qty 1 pcs		
<b>For models:</b>	C35, C35E, C43, C43-2, C43ALTA, C43D, C43DE, C43E, C46DE, C46E, C48, C48-2, C48D, C48D-2, C48DDL, C48DL, C48E, C6, C6D, C6DE, C6E, C6EBT, C81, C81E, C81EBT, C90, C90DE, C90E, C90EBT, CDN3, CDN4, CR43, CR43D, CR48, CR48D, EDI13, EDI13ALTA, EDI6, EDI8, GS-X1011, GS-X1011-2, GS-X1011-WEH, GS-X1011-WEH-2, LO134, LO134ALTA, LO50, LO50E, LO67, LO83, RLO200...(Other models you can see in the webshop)		

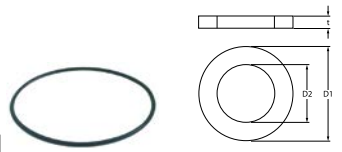

1

<b>GEV No.</b>	528800	<b>Ref. No.</b>	33183 34224
<b>description</b>	O-ring EPDM thickness 2.62mm ID $\varnothing$ 75.87mm Qty 1 pcs		
<b>For models:</b>	C3, C35, C4, C43, C43D, C48, C48D, C98, CDN3, CDN4, CR43, CR43D, CR48, CR48D, EDI13, EDI13-2, EDI13ALTA, EDI13ALTA-2, EDI6, EDI6-2, EDI8, EDI8-2, HD130BT, HD60BT, HD80BT, LO134, LO134-2, LO134ALTA, LO134ALTA-2, LO62, LO67, LO67-2, LO83, LO83-2, RLO200, RLO300, RLO400, SMW15E, SP35, SP35D, SP40, SP40D, SPB35, SPR36, SPR36D, SPR41, SPR41D		



1

<b>GEV No.</b>	511322	<b>Ref. No.</b>	200869 30479
<b>description</b>	O-ring EPDM thickness 3.53mm ID $\varnothing$ 20.22mm Qty 1 pcs		
<b>For models:</b>	60EBT, AP53E, AP60E, C35E, C43-2, C43ALTA, C43DE, C43E, C46DE, C46E, C48-2, C48D-2, C48DDL, C48DL, C48E, C53, C53D, C53DE, C53E, C60DE, C60E, C68DE, C68E, C68EBT, C6DE, C6E, C6EBT, DP35, DP35-2, DP35D, DP35D-2, DP40, DP40-2, DP40D, DP40D-2, DP40D-rib2, DP40-rib2, DP45, DP45D, DP45DE, DP45E, DP50DE, DP50E, DP50EBT, ED700-90, ED900-90, GS-X1011, GS-X1011-2, GS-X1011-WEH, GS-X1011-WEH-2...(Other models you can see in the webshop)		

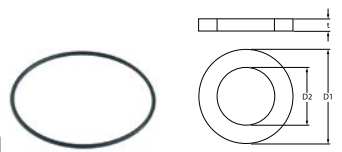

1

<b>GEV No.</b>	512235	<b>Ref. No.</b>	31057 31784
<b>description</b>	O-ring EPDM thickness 2.62mm ID $\varnothing$ 88.57mm Qty 1 pcs		
<b>For models:</b>	APS43, APS48, APS48B, APS53, APS60, APSE43, APSE48, APSE53, APSE60, C53, C53D, C60, C60D, DP35, DP35D, DP40, DP40D, DP45, DP45D, DP50, DP50D, FW35, FW40, FW40B, FW45, FW50, INDY43F, INDY48F, INDY53F, INDY60F, SP45, SP45D, SP50, SP50-400V, SP50-440V, SP50D, STS43, STS43D, STS48, STS48D, STS53, STS53D, STS60, STS60D, TS48, UNI43C, UNI48C, UNI48CD, UNI53C, UNI60C		

Зип Общежит

vsezip.ru

+7(812)987-08-81



Зип Общепит  
vsezip.ru  
+7(812)987-08-81



<b>GEV No.</b>	511521	<b>Ref. No.</b>	30344
<b>description</b>	O-ring EPDM thickness 3.53mm ID ø 28.17mm Qty 10 pcs		
<b>For models:</b>	BPN48, BPS43, BPS52		



<b>GEV No.</b>	521120	<b>Ref. No.</b>	25249
<b>description</b>	O-ring EPDM thickness 5.34mm ID ø 37.47mm Qty 1 pcs		

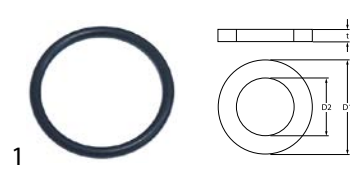

<b>GEV No.</b>	510899	<b>Ref. No.</b>	200830 H200830
<b>description</b>	O-ring EPDM thickness 3.53mm ID ø 37.69mm Qty 1 pcs		
<b>For models:</b>	AC101, AC151, AC181, AC201, AC241, AC91, EDT100, EDT140, EDT170, EDT200, EDT230, EDT85, TR100, TR140, TR170, TR200, TR230, TR90, TR-E100, TR-E150, TR-E170, TR-E200, TR-E230, TR-E90		

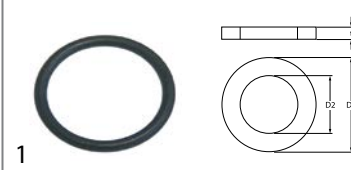

<b>GEV No.</b>	510408	<b>Ref. No.</b>	200820 8662
<b>description</b>	O-ring EPDM thickness 5.34mm ID ø 47mm Qty 1 pcs		
<b>For models:</b>	60EBT, AP43E, AP48E, C35E, C43DE, C43E, C46DE, C46E, C53DE, C53E, C6, C60DE, C60E, C68DE, C68E, C68EBT, C6D, C6DE, C6E, C6EBT, DP45DE, DP45E, DP50DE, DP50E, DP50EBT, FW35E, FW40E, SP35DE, SP35E, SP40DE, SP40E, SP45DE, SP45E, SP50DE, SP50E, SPB35E, ST43DE, ST43E, ST48DE, ST48E, ST48EBT, ST53DE, ST53E, ST60DE, ST60E, ST60EBT		

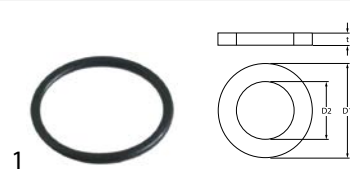

<b>GEV No.</b>	506015	<b>Ref. No.</b>	25246
<b>description</b>	O-ring EPDM thickness 3.53mm ID ø 39.69mm Qty 1 pcs		
<b>For models:</b>	C43D, C43DE, C46DE, C46E, C48D, C48D-2, C48DDL, C48E, C53D, C53DE, C60D, C60DE, C68DE, C68E, C6D, C6DE, C90DE, C90DE2, CDN3, CDN4, CMD43, CMD48, CMD52, CMD60, CR43D, CR48D, DP35D, DP35D-2, DP40D, DP40D-2, DP40D-rib2, DP45D, DP45DE, DP50D, DP50D-115V, DP50DE, GS-X1011, GS-X1011-2, GS-X1011-WEH, GS-X1011-WEH-2, GS-X1021, GS-X1021-2, GS-X1021-2rib, GS-X1021-WEH, GS-X1021-WEH-2, GS-X1021-WEH-2rib, NKD43, NKD48, NKD52, NKD60...(Other models you can see in the webshop)		

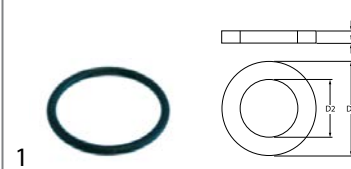

<b>GEV No.</b>	510409	<b>Ref. No.</b>	200815 33402 H200815
<b>description</b>	O-ring EPDM thickness 5.34mm ID ø 56.52mm Qty 1 pcs		
<b>For models:</b>	60BT, 60BT-3, 60EBT, AC101, AC151, AC181, AC201, AC241, AC91, AP53E, AP60E, APS43, APS48, APS48B, APS53, APS60, C53, C53D, C53DE, C53E, C60, C60D, C60DE, C60E, C68DE, C68E, C68EBT, C6DE, C6E, C6EBT, C81, C81E, C81EBT, C90, C90DE, C90DE2, C90E, C90E2, C90EBT, C90EBT2, C98, CA120, CA55, CA90, CAP10, CAP10BT, CAP10DE, CAP12, CAP12DE, CAP12EBT...(Other models you can see in the webshop)		



<b>GEV No.</b>	528192	<b>Ref. No.</b>	200842 31948
<b>description</b>	O-ring EPDM thickness 3mm ID ø 56mm Qty 1 pcs		
<b>For models:</b>	60EBT, AP43E, AP48E, AP53E, AP60E, APS43, APS48, APS48B, APS53, APS60, APSE43, APSE48, APSE53, APSE60, BPN48, BPS43, BPS52, C35E, C43-2, C43DE, C43E, C46DE, C46E, C48-2, C48D-2, C48E, C53DE, C53E, C60DE, C60E, C68DE, C68E, C68EBT, C6DE, C6E, C6EBT, DP35-2, DP35D-2, DP40-2, DP40D-2, DP40D-rib2, DP40-rib2, DP45DE, DP45E, DP50DE, DP50E, DP50EBT, FW35, FW35E, FW40...(Other models you can see in the webshop)		

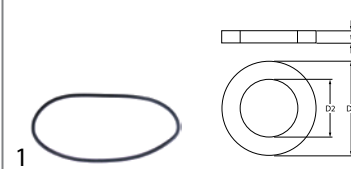

<b>GEV No.</b>	510551	<b>Ref. No.</b>	26223 27066 33855
<b>description</b>	pump cover gasket ID ø 158.3mm pump type 1214/1293/1225/2243/1226/1204/3473/1241 thickness 3.53mm EPDM Qty 1 pcs		
<b>For models:</b>	C81, C81E, C81EBT, C90, C90DE, C90DE2, C90E, C90E2, C90EBT, C90EBT2, C98, CA120, CA55, CA90, CAP10, CAP10BT, CAP10DE, CAP12, CAP12DE, CAP12EBT, CAP7, CAP7E, ED550, ED600-95, ED630-90, ED650E, ED650E-90, ED650S, ED650S-90, ED700, ED900-90, ED113, ED113-2, ED113ALTA, ED113ALTA-2, ED113ALTABT, ED113BT, EDI4, EDI5, EDI6, EDI6-2, EDI6BT, EDI8, EDI8-2, EDI8BT, HD130BT, HD40ALTABT, HD40BT, HD60BT, HD80BT...(Other models you can see in the webshop)		



<b>GEV No.</b>	524483	<b>Ref. No.</b>	200807
<b>description</b>	O-ring EPDM thickness 4mm ID ø 110mm Qty 1 pcs		
<b>For models:</b>	C90DE2, C90E2, C90EBT2, CAP10, CAP10DE, CAP12, CAP12DE, CAP12EBT, CAP15EBT, CAP7E, EDI4, HD40ALTABT, HD40BT, HT150, HTP195, HTP205, HTP220		

NBR



<b>GEV No.</b>	532720	<b>Ref. No.</b>	200878
<b>description</b>	O-ring NBR ID $\varnothing$ 17.86mm thickness 2.62mm Qty 1 pcs		
<b>For models:</b>	HT100, HT150, HTP195, HTP205, HTP220		

## sealing washers

## fibre gaskets



<b>GEV No.</b>	504431	<b>Ref. No.</b>	25274 460535
<b>description</b>	flat gasket FIBER ED $\varnothing$ 12mm ID $\varnothing$ 6mm thickness 2mm Qty 1 pcs		
<b>For models:</b>	AP43E, AP48E, AP53E, AP60E, APS43, APS48, APS48B, APS53, APS60, APSE43, APSE48, APSE53, APSE60, BPN48, BPS43, BPS52, C3, C35, C35E, C4, C43, C43-2, C43ALTA, C43D, C43DE, C43E, C46DE, C46E, C48, C48-2, C48D, C48D-2, C48DDL, C48DL, C48E, C53, C53D, C6, C60, C60D, C6D, CDN3, CDN4, CM43, CM48, CM52, CM60, CMD43, CMD48, CMD52...(Other models you can see in the webshop)		



<b>GEV No.</b>	503003	<b>Ref. No.</b>	32520
<b>description</b>	flat gasket FIBER ED $\varnothing$ 27mm ID $\varnothing$ 21mm thickness 2mm Qty 1 pcs		
<b>For models:</b>	ED600-95, ED700-90, ED900-90, EDI5, LO122, LO60, LO61, LO78		



<b>GEV No.</b>	510996	<b>Ref. No.</b>	H460502
<b>description</b>	flat gasket FIBER ED $\varnothing$ 31mm ID $\varnothing$ 21.5mm thickness 2mm for thread 1/2" Qty 1 pcs		
<b>For models:</b>	C90, C90DE, C90E, C90EBT, C98, CA120, CA55, CA90, CAP10, CAP10BT, CAP12, CAP7, CAP7E, ED550, ED650E, ED650S, EDI13-2, EDI13ALTA-2, EDI13ALTABT, EDI13BT, EDI6-2, EDI6BT, EDI8-2, EDI8BT, EDT100, EDT140, EDT170, EDT200, EDT230, EDT85, LO134-2, LO134ALTA-2, LO50, LO50E, LO62, LO67-2, LO83-2, RCA1100, RCA1200, RCA1200i, RLO50, SMW15, SMW15E, SO100, SO100-400V3-50Hz-MARINE, SO100-440V3-60Hz-MARINE, SO120, SO55, SO55-400V3-50Hz-MARINE, SO55-440V3-60Hz-MARINE...(Other models you can see in the webshop)		

Зип Общепит

vsezip.ru

+7(812)987-08-81

<b>GEV No.</b>	510355	<b>Ref. No.</b>	33372 460501
<b>description</b>	gasket fibre ED $\varnothing$ 24mm ID $\varnothing$ 17mm thickness 2mm Qty 1 pcs		
<b>For models:</b>	AC101, AC151, AC181, AC201, AC241, AC91, C81, C81E, C81EBT, C90, C90DE, C90E, C90EBT, C98, CA120, CA55, CA90, CAP7, CAP7E, ED550, ED650E, ED650S, EDI13, EDI13-2, EDI13ALTA, EDI13ALTA-2, EDI6, EDI8, EDI8-2, EDT100, EDT140, EDT170, EDT200, EDT230, EDT85, LO134, LO134-2, LO134ALTA, LO134ALTA-2, LO50, LO50E, LO62, LO67, LO83, LO83-2, RCA1100, RCA1200, RCA1200i, RLO300, RLO400...(Other models you can see in the webshop)		

## rubber gaskets



<b>GEV No.</b>	505313	<b>Ref. No.</b>	200482 33453
<b>description</b>	flat gasket Neoprene ED $\varnothing$ 50mm ID $\varnothing$ 35mm thickness 4mm Qty 1 pcs		
<b>For models:</b>	C81, C81E, C81EBT, C90, C90DE, C90DE2, C90E, C90E2, C90EBT, C90EBT2, C98, CA120, CA55, CA90, CAP10, CAP10BT, CAP10DE, CAP12, CAP12DE, CAP12EBT, CAP15EBT, CAP7, CAP7E, ED550, ED650E, ED650S, EDI4, HD40ALTABT, HD40BT, LO50, LO50E, LO56, LO62, RCA1100, RCA1200, RCA1200i, RLO50, SMW15, SMW15E, SO100, SO100-400V3-50Hz-MARINE, SO100-440V3-60Hz-MARINE, SO120, SO55, SO55-400V3-50Hz-MARINE, SO55-440V3-60Hz-MARINE, SO55E, SP81, SP81E, US-X501		



<b>GEV No.</b>	510761	<b>Ref. No.</b>	25263
<b>description</b>	flat gasket rubber D1 $\varnothing$ 38mm D2 $\varnothing$ 25mm thickness 2mm Qty 1 pcs		
<b>For models:</b>	60BT, 60BT-3, 60EBT, APS43, APS48, APS48B, APS53, APS60, APSE43, APSE48, APSE53, APSE60, BPN48, BPS43, BPS52, C3, C35, C35E, C4, C43, C43-2, C43ALTA, C43D, C43DE, C43E, C46DE, C46E, C48, C48-2, C48D, C48D-2, C48DDL, C48DL, C48E, C53, C53D, C53DE, C53E, C6, C60, C60D, C60DE, C60E, C68DE, C68E, C68EBT, C6D, C6DE, C6E, C6EBT...(Other models you can see in the webshop)		





<b>GEV No.</b>	512070	<b>Ref. No.</b>	25257
<b>description</b>	flat gasket rubber ED $\varnothing$ 17.5mm ID $\varnothing$ 13mm thickness 2mm Qty 1 pcs		
<b>For models:</b>	APS43, APS48, APS53, APS60, APSE43, APSE48, APSE53, APSE60, C3, C35, C4, C43, C43D, C48, C48D, C53, C53D, C60, C60D, E36, E40, E40-2F, INDY43F, INDY48F, INDY53F, INDY60F, K80F, K80G, SP35, SP35D, SP40, SP40D, SP45, SP45D, SP50, SP50D, T3-80, T4-80, T5-80, UNI43C, UNI48C, UNI48CD, UNI53C, UNI60C		





Зип Общепит  
vsezip.ru

			
1			
<b>GEV No.</b>	512376	<b>Ref. No.</b>	25266
<b>description</b>	flat gasket rubber ED ø 18mm ID ø 10mm thickness 2mm Qty 1 pcs		
<b>For models:</b>	60BT, 60BT-3, 60EBT, AP43E, AP48E, AP53E, AP60E, APS43, APS18, APS48B, APS53, APS60, APSE43, APSE48, APSE53, APSE60, BPN48, BPS43, BPS52, C3, C35, C35E, C4, C43, C43-2, C43ALTA, C43D, C43DE, C43E, C46DE, C46E, C48, C48-2, C48D, C48D-2, C48DDL, C48DL, C48E, C53, C53D, C53DE, C53E, C6, C60, C60D, C60DE, C60E, C68DE, C68E, C68EBT...(Other models you can see in the webshop)		

			
1			
<b>GEV No.</b>	510877	<b>Ref. No.</b>	200415 H200415
<b>description</b>	flat gasket rubber ED ø 18mm ID ø 10mm thickness 3mm Qty 1 pcs		
<b>For models:</b>	60EBT, AC101, AC151, AC181, AC201, AC241, AC91, C53DE, C53E, C6, C60DE, C60E, C68DE, C68E, C68EBT, C6D, C6DE, C6E, C6EBT, DP45DE, DP45E, DP50DE, DP50E, DP50EBT, EDT100, EDT140, EDT170, EDT200, EDT230, EDT85, HG2LR, HGLR, SP45DE, SP45E, SP5, SP50DE, SP50E, SP50E-400V3-50Hz-MARINE, SP50E-440V3-60Hz-MARINE, SP5D, SP5DE, SP5E, SP68DE, SP68E, ST53DE, ST53E, ST60DE, ST60E, ST60EBT		

			
1			
<b>GEV No.</b>	511283	<b>Ref. No.</b>	H200927
<b>description</b>	flat gasket rubber ED ø 30mm ID ø 20mm thickness 2mm Qty 1 pcs		
<b>For models:</b>	C81E, CAP10, CAP10BT, CAP12, EDI13ALTABT, EDI13BT, EDI4, EDI5, EDI6BT, EDI8BT, EDT100, EDT140, EDT170, EDT200, EDT230, EDT85, LO56, LO61, SO100, SO100-400V3-50Hz-MARINE, SO100-440V3-60Hz-MARINE, SO120, SP81E, TR100, TR140, TR170, TR200, TR230, TR90, TR-E100, TR-E150, TR-E170, TR-E200, TR-E230, TR-E90		

			
1			
<b>GEV No.</b>	512073	<b>Ref. No.</b>	25267
<b>description</b>	flat gasket rubber ED ø 31mm ID ø 22mm thickness 2mm Qty 1 pcs		
<b>For models:</b>	E36, E40-2F, ED600-95, ED630-90, ED650S, ED650S-90, ED700-90, ED900, ED900-90, EDI13, EDI13-2, EDI13ALTA, EDI13ALTA-2, EDI6, EDI6-2, EDI8, EDI8-2, K80F, K80G, LO122, LO134, LO134-2, LO134ALTA, LO134ALTA-2, LO60, LO67, LO67-2, LO78, LO83, LO83-2, RLO200, RLO300, RLO400, T3-80, T4-80, T5-80		

			
1			
<b>GEV No.</b>	512346	<b>Ref. No.</b>	25261
<b>description</b>	flat gasket rubber ED ø 44mm ID ø 32mm thickness 2.5mm Qty 1 pcs		
<b>For models:</b>	CM43, CM48, CM52, CM60, CMD43, CMD48, CMD52, CMD60, E36, E40, E43, E50, ED600-95, ED630-90, ED650E, ED650E-90, ED650S, ED650S-90, ED700, ED700-90, ED900, ED900-90, EDI5, K80F, K80G, LO122, LO60, LO61, LO78, M60, NK43, NK48, NK52, NK60, NKD43, NKD48, NKD52, NKD60, T3-80, T4-80, T5-80, T6-80, UNI43R, UNI43RD, UNI48R, UNI48RD, UNI53R, UNI53RD		

			
1			
<b>GEV No.</b>	510876	<b>Ref. No.</b>	33530 H200412
<b>description</b>	flat gasket rubber ED ø 45mm ID ø 33mm thickness 3mm Qty 1 pcs		
<b>For models:</b>	C81, C81E, C81EBT, C90, C90DE, C90DE2, C90E, C90E2, C90EBT, C90EBT2, C98, CA120, CA55, CA90, CAP10, CAP10BT, CAP10DE, CAP12, CAP12DE, CAP12EBT, CAP7, CAP7E, ED550, ED600-95, ED650E, ED650S, ED700-90, EDI13, EDI13-2, EDI13ALTA, EDI13ALTA-2, EDI13ALTABT, EDI13BT, EDI4, EDI5, EDI6, EDI6-2, EDI6BT, EDI8, EDI8-2, EDI8BT, EDT100, EDT140, EDT170, EDT200, EDT230, EDT85, HD130BT, HD40ALTABT, HD40BT...(Other models you can see in the webshop)		

			
1			
<b>GEV No.</b>	511196	<b>Ref. No.</b>	200919
<b>description</b>	flat gasket rubber ED ø 59mm ID ø 48mm thickness 2mm Qty 1 pcs		
<b>For models:</b>	60EBT, C68EBT, C6EBT, C81EBT, C90EBT2, CAP10BT, CAP12EBT, DP50EBT, EDI13ALTABT, EDI13BT, EDI4, EDI6BT, EDI8BT, HD130BT, HD40ALTABT, HD40BT, HD60BT, HD80BT, ST48EBT, ST60EBT		

			
1			
<b>GEV No.</b>	512217	<b>Ref. No.</b>	25259
<b>description</b>	flat gasket rubber ED ø 61mm ID ø 47.5mm thickness 3mm Qty 1 pcs equiv. no. 25259 suitable for HOONVED		
<b>For models:</b>	CM43, CM48, CM52, CM60, CMD43, CMD48, CMD52, CMD60, E36, E40, E43, E50, NK43, NK48, NK52, NK60, NKD43, NKD48, NKD52, NKD60, UNI43R, UNI43RD, UNI48R, UNI48RD, UNI53R, UNI53RD		

			
1			
<b>GEV No.</b>	512140	<b>Ref. No.</b>	31423
<b>description</b>	flat gasket rubber ED ø 65mm ID ø 51mm thickness 3mm Qty 1 pcs		
<b>For models:</b>	60BT, 60BT-3, APS60, C35, C43, C43ALTA, C43D, C48, C48D, C48DDL, C48DL, C53, C53D, C6, C60, C60D, C6D, CDN3, CDN4, CM48, CM52, CMD43, CMD52, CR43, CR43D, CR48, CR48D, DP35, DP35D, DP40, DP40D, DP45, DP45D, DP50, DP50D, DP50D-115V, FW50, GS-X1011, GS-X1011-WEH, GS-X1021, GS-X1021-WEH, RSP50, RSP50A, SD5BT, SP35, SP35ALTA, SP35D, SP40, SP40D, SP40DDL...(Other models you can see in the webshop)		

			
1			
<b>GEV No.</b>	512350	<b>Ref. No.</b>	25260
<b>description</b>	flat gasket rubber ED ø 65mm ID ø 51mm thickness 3mm Qty 1 pcs equiv. no. 25260 suitable for HOONVED		
<b>For models:</b>	BPS43, C3, C4, C53, C60, CM43, CM48, CM52, CM60, CMD43, CMD48, CMD52, CMD60, E36, E40, E43, E50, ED630-90, M60, NK43, NK48, NK52, NK60, NKD43, NKD48, NKD52, NKD60, T3-80, T4-80, T5-80, T6-80, TS43, TS48		

Зип, Общепит

plastic gaskets

vsezip.ru

17(812)987-08-81

			
1			
<b>GEV No.</b>	516254	<b>Ref. No.</b>	33529 H200410
<b>description</b>	flat gasket rubber ED ø 66mm ID ø 46mm thickness 2mm Qty 1 pcs		
<b>For models:</b>	60BT-3, C81, C81E, C90, C90DE, C90E, C90EBT, C98, CA120, CA55, CA90, CAP7, CAP7E, ED550, ED600-95, ED650E, ED650S, ED700-90, EDI13, EDI13-2, EDI13ALTA, EDI13ALTA-2, EDI13ALTABT, EDI13BT, EDI5, EDI6, EDI6-2, EDI6BT, EDI8, EDI8-2, EDI8BT, EDT100, EDT140, EDT170, EDT200, EDT230, EDT85, LO134, LO134-2, LO134ALTA, LO134ALTA-2, LO50, LO50E, LO60, LO61, LO62, LO67, LO67-2, LO78, LO83...(Other models you can see in the webshop)		

			
1			
<b>GEV No.</b>	510875	<b>Ref. No.</b>	26289
<b>description</b>	flat gasket rubber ED ø 68mm ID ø 48mm thickness 2mm Qty 1 pcs		
<b>For models:</b>	ED600-95, ED630-90, ED650E, ED650E-90, ED650S, ED650S-90, ED700, ED700-90, ED900, ED900-90, EDI5, K80F, K80G, LO122, LO60, LO61, LO78		

			
1			
<b>GEV No.</b>	510832	<b>Ref. No.</b>	H200906
<b>description</b>	flat gasket rubber ED ø 92mm ID ø 66mm thickness 2mm Qty 1 pcs equiv. no. 200906/33456		
<b>For models:</b>	C81, C90, C90EBT, C98, CA120, CA55, CA90, CAP7, CAP7E, ED550, ED650E, ED650S, EDI13-2, EDI13ALTA-2, EDI6-2, EDI6BT, EDI8-2, EDT100, EDT140, EDT170, EDT200, EDT230, EDT85, LO134-2, LO134ALTA-2, LO50, LO62, LO67-2, LO83-2, RCA1100, RCA1200, RCA1200i, RLO50, SMW15, SO55, SO55E, SP81, TR100, TR140, TR170, TR200, TR230, TR90, TR-E100, TR-E150, TR-E170, TR-E200, TR-E230, TR-E90, US-X501		

			
1			
<b>GEV No.</b>	510883	<b>Ref. No.</b>	25265
<b>description</b>	gasket rubber ED ø 86mm ID ø 66mm thickness 2mm for salt tank Qty 1 pcs		
<b>For models:</b>	C43D, C48D, C48D-2, C48DDL, C48E, C53D, C53DE, C60D, C60DE, C68DE, C68E, C6D, C6DE, C90DE2, CDN3, CDN4, CMD43, CMD48, CMD52, CR43D, CR48D, DP35D, DP35D-2, DP40D, DP40D-2, DP40D-rib2, DP45D, DP50D, DP50D-115V, GS-X1011, GS-X1011-2, GS-X1011-WEH, GS-X1011-WEH-2, GS-X1021, GS-X1021-2, GS-X1021-2rib, GS-X1021-WEH, GS-X1021-WEH-2, GS-X1021-WEH-2rib, NKD43, NKD48, NKD52, RSP40A, RSP50A, SP35D, SP40D, SP40D-2, SP40DDL, SP40E, SP45D...(Other models you can see in the webshop)		

			
1			
<b>GEV No.</b>	510450	<b>Ref. No.</b>	34192
<b>description</b>	gasket plastic ED ø 14mm ID ø 8mm thickness 3mm Qty 1 pcs		
<b>For models:</b>	AP53E, AP60E, C53DE, C53E, C60DE, C60E, C68DE, C68E, C6DE, C6E, C81EBT, C90EBT2, C98, DP45DE, DP45E, DP50DE, DP50E, EDI13, EDI13-2, EDI13ALTA, EDI13ALTA-2, EDI4, EDI6, EDI6-2, EDI8, EDI8-2, HD40ALTABT, HD40BT, HD60BT, HD80BT, LO134, LO134-2, LO134ALTA, LO134ALTA-2, LO56, LO62, LO67, LO67-2, LO83, LO83-2, RLO200, RLO300, RLO400, SP45DE, SP45E, SP50DE, SP50E, SP50E-400V3-50Hz-MARINE, SP50E-440V3-60Hz-MARINE, SP5DE...(Other models you can see in the webshop)		

			
1			
<b>GEV No.</b>	511146	<b>Ref. No.</b>	H200495
<b>description</b>	gasket plastic ED ø 43mm ID ø 36mm Qty 1 pcs		

## foam rubber gaskets

			
1			
<b>GEV No.</b>	505307	<b>Ref. No.</b>	00991 35996
<b>description</b>	foam rubber gasket W 15mm thickness 5mm suitable for HOONVED with layer		
<b>For models:</b>	C98, ED600-95, ED700-90, ED900-90, EDI13, EDI13-2, EDI13ALTA, EDI13ALTA-2, EDI5, EDI6, EDI6-2, EDI8, EDI8-2, LO122, LO134, LO134-2, LO134ALTA, LO134ALTA-2, LO60, LO61, LO62, LO67, LO67-2, LO78, LO83, LO83-2, RLO200, RLO300, RLO400		

			
1			
<b>GEV No.</b>	505303	<b>Ref. No.</b>	200957 H200957
<b>description</b>	foam rubber gasket W 28mm thickness 2.7mm self-adhesive Qty 640mm punched		
<b>For models:</b>	CAP10, CAP10BT, CAP10DE, CAP12, CAP12DE, CAP12EBT, CAP7E, SO100, SO100-400V3-50Hz-MARINE, SO100-440V3-60Hz-MARINE, SO120		





Зип Общежит  
Special gaskets

vsezip.ru

+7(812)987-08-814



1

<b>GEV No.</b>	505309	<b>Ref. No.</b>	33409
<b>description</b>	foam rubber gasket W 29mm thickness 3mm self-adhesive Qty 600mm suitable for HOONVED punched		
<b>For models:</b>	CA120, CA55, CA90, CAP7, CAP7E, ED550, ED650E, ED650S, RCA1100, RCA1200, RCA1200i, SO55, SO55-400V3-50Hz-MARINE, SO55-440V3-60Hz-MARINE, SO55E		



1

<b>GEV No.</b>	510881	<b>Ref. No.</b>	H200433
<b>description</b>	foam rubber gasket W 6mm thickness 2.5mm self-adhesive Qty 1m		
<b>For models:</b>	C35E, C43DE, C43E, C46DE, C46E, C98, EDI13-2, EDI13ALTA-2, EDI13ALTABT, EDI13BT, EDI4, EDI6-2, EDI6BT, EDI8-2, EDI8BT, LO134-2, LO134ALTA-2, LO56, LO62, LO67-2, LO83-2, SP35DE, SP35E, SP40DE, SP40E, SPB35E, TR170, TR-E170		



1

<b>GEV No.</b>	510880	<b>Ref. No.</b>	33408
<b>description</b>	foam rubber gasket W 8mm thickness 4mm self-adhesive Qty supplied by meter		
<b>For models:</b>	60BT, 60BT-3, 60EBT, C35, C43-2, C48-2, C48D-2, C48E, C53DE, C53E, C6, C60DE, C60E, C68DE, C68E, C68EBT, C6D, C6DE, C6E, C6EBT, C81, C81E, C81EBT, CA120, CA55, CA90, CAP7, CAP7E, DP35, DP35-2, DP35D, DP35D-2, DP40, DP40-2, DP40D, DP40D-2, DP40D-rib2, DP40-rib2, DP45, DP45D, DP50, DP50D, DP50D-115V, ED550, ED650E, ED650S, EDI13-2, EDI13ALTA-2, EDI13ALTABT, EDI13BT...(Other models you can see in the webshop)		

shaft gaskets

v-rings



1

<b>GEV No.</b>	511631	<b>Ref. No.</b>	H200480
<b>description</b>	gasket ID ø 13.5mm ED ø 26mm H 10mm		
<b>For models:</b>	EDT100, EDT140, EDT170, EDT200, EDT230, EDT85, TR100, TR140, TR170, TR200, TR230, TR90, TR-E100, TR-E150, TR-E170, TR-E200, TR-E230		

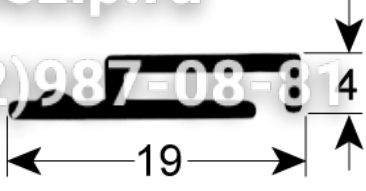

1

<b>GEV No.</b>	511311	<b>Ref. No.</b>	H200923
<b>description</b>	door seal L 1000mm dishwasher suitable for COMENDA equiv. no. 200923		
<b>For models:</b>	EDI13-2, EDI13ALTA-2, EDI6-2, EDI8-2, LO134-2, LO134ALTA-2, LO67-2, LO83-2		

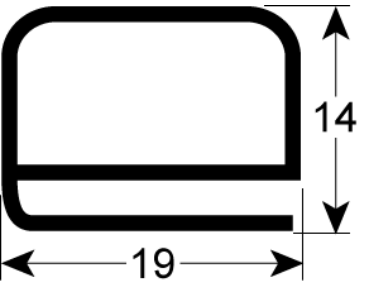

1

<b>GEV No.</b>	511990	<b>Ref. No.</b>	36926
<b>description</b>	door seal L 590mm		
<b>For models:</b>	60EBT, C53DE, C53E, C60DE, C60E, C68DE, C68E, C68EBT, C6DE, C6E, SP45DE, SP45E, SP50DE, SP50E, SP50E-400V3-50Hz-MARINE, SP50E-440V3-60Hz-MARINE, SP5DE, SP5E, SP68DE, SP68E		

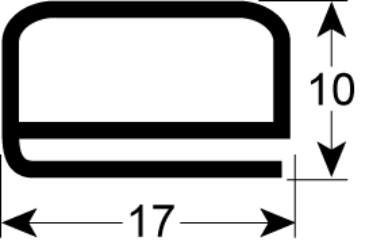

1

<b>GEV No.</b>	511989	<b>Ref. No.</b>	36883
<b>description</b>	door seal Qty supplied by meter		
<b>For models:</b>	EDI13-2, EDI13ALTA-2, EDI13ALTABT, EDI13BT, EDI4, EDI6-2, EDI6BT, EDI8-2, EDI8BT, HD130BT, HD40ALTABT, HD40BT, HD60BT, HD80BT, LO134-2, LO134ALTA-2, LO56, LO67-2, LO83-2		



1

<b>GEV No.</b>	510881	<b>Ref. No.</b>	H200433
<b>description</b>	foam rubber gasket W 6mm thickness 2.5mm self-adhesive Qty 1m		
<b>For models:</b>	C35E, C43DE, C43E, C46DE, C46E, C98, EDI13-2, EDI13ALTA-2, EDI13ALTABT, EDI13BT, EDI4, EDI6-2, EDI6BT, EDI8-2, EDI8BT, LO134-2, LO134ALTA-2, LO56, LO62, LO67-2, LO83-2, SP35DE, SP35E, SP40DE, SP40E, SPB35E, TR170, TR-E170		

Зип-Общепит

the most gaskets

vsezip.ru

+7(812)987-08-81



1

<b>GEV No.</b>	510880	<b>Ref. No.</b>	33408
<b>description</b>	foam rubber gasket W 8mm thickness 4mm self-adhesive Qty supplied by meter		
<b>For models:</b>	60BT, 60BT-3, 60EBT, C35, C43-2, C48-2, C48D-2, C48E, C53DE, C53E, C6, C60DE, C60E, C68DE, C68E, C68EBT, C6D, C6DE, C6E, C6EBT, C81, C81E, C81EBT, CA120, CA55, CA90, CAP7, CAP7E, DP35, DP35-2, DP35D, DP35D-2, DP40, DP40-2, DP40D, DP40D-2, DP40D-rib2, DP40-rib2, DP45, DP45D, DP50, DP50D, DP50D-115V, ED550, ED650E, ED650S, EDI13-2, EDI13ALTA-2, EDI13ALTABT, EDI13BT...(Other models you can see in the webshop)		



1

<b>GEV No.</b>	501353	<b>Ref. No.</b>	200491 H200491
<b>description</b>	gasket for thermostat hole ø 6.6mm L 98mm W 68mm thickness 2mm		
<b>For models:</b>	AC101, AC151, AC181, AC201, AC241, AC91, EDT100, EDT140, EDT170, EDT200, EDT230, EDT85, TR100, TR140, TR170, TR200, TR230, TR90, TR-E100, TR-E150, TR-E170, TR-E200, TR-E230, TR-E90		

miscellaneous



1

<b>GEV No.</b>	512039	<b>Ref. No.</b>	26515
<b>description</b>	gasket for boiler		
<b>For models:</b>	CM43, CM48, CM52, CM60, CMD43, CMD48, CMD52, CMD60, E40, E43, E50, ED700-90, ED900-90, K80F, K80G, LO122, LO78, NK43, NK48, NK52, NK60, NKD43, NKD48, NKD52, NKD60, T3-80, T4-80, T5-80, T6-80, UNI43R, UNI43RD, UNI48R, UNI48RD, UNI53R, UNI53RD		



1

<b>GEV No.</b>	512154	<b>Ref. No.</b>	H200494
<b>description</b>	gasket for thermostat ID ø 20mm equiv. no. 200494/H200494 hole distance 41mm suitable for COMENDA, HOONVED		
<b>For models:</b>	60BT, 60BT-3, APS43, APS48, APS48B, APS53, APS60, APSE43, APSE48, APSE53, APSE60, C35, C35E, C43, C43-2, C43ALTA, C43D, C43DE, C43E, C46DE, C46E, C48, C48-2, C48D, C48D-2, C48DDL, C48DL, C48E, C53, C53D, C6, C60, C60D, C6D, CDN3, CDN4, CR43, CR43D, CR48, CR48D, DP35, DP35-2, DP35D, DP35D-2, DP40, DP40-2, DP40D, DP40D-2, DP40D-rib2, DP40-rib2...(Other models you can see in the webshop)		



1

<b>GEV No.</b>	505314	<b>Ref. No.</b>	31063
<b>description</b>	gasket for wash arm thickness 1mm L 74.5mm W 42mm		
<b>For models:</b>	ED600-95, ED700-90, ED900-90, EDI5, LO122, LO60, LO61, LO78		

## transmission technology and ball bearings

### chains

#### roller chains 08B-1 single





1

<b>GEV No.</b>	511370	<b>Ref. No.</b>	160837 H160837
<b>description</b>	gasket L 34mm W 14mm for door guides ID ø 7mm thickness 3mm		
<b>For models:</b>	APS43, APS48, APS48B, APS53, APS60, C81, C90, DP35, DP35-2, DP35D, DP35D-2, DP40, DP40-2, DP40D, DP40D-2, DP40D-rib2, DP40-rib2, DP45, DP45D, DP50, DP50D, FW35, FW40, FW40B, FW45, FW50, LO50, RLO50, SP81, STS43, STS43-2, STS43D, STS43D-2, STS48, STS48-2, STS48D, STS48D-2, STS48D-rib2, STS48-rib2, STS53, STS53D, STS60, STS60D, US-X501		



1

<b>GEV No.</b>	697897	<b>Ref. No.</b>	H410801
<b>description</b>	roller chain DIN/ISO 08 B-1 splitting 1/2" / 12.7mm links 39 internal width 7.75mm rollerø 8.51mm single		
<b>For models:</b>	EDT100, EDT140, EDT170, EDT200, EDT230, EDT85, TR100, TR140, TR170, TR200, TR230, TR90, TR-E100, TR-E150, TR-E170, TR-E200, TR-E230		
<b>accessories for</b>	697897		
	<b>GEV No.</b>	693276	<b>Ref. No.</b> H410903
	connector single DIN/ISO 08 B-1 splitting 1/2" links 1 L 23mm internal width 11.8mm rollerø 4.3mm metal		
	<b>GEV No.</b>	697841	<b>Ref. No.</b> H410902
	half link single DIN/ISO 08 B-1 splitting 1/2"		



1

<b>GEV No.</b>	510885	<b>Ref. No.</b>	33784
<b>description</b>	gasket suitable for COMENDA equiv. no. 200464 L 60mm W 30mm		
<b>For models:</b>	CDN3, CDN4, CR43, CR43D, CR48, CR48D, SPR36, SPR36D, SPR41, SPR41D		



connectors



1

<b>GEV No.</b>	693276	<b>Ref. No.</b>	H410903
<b>description</b>	connector single DIN/ISO 08 B-1 splitting 1/2" links 1 L 23mm internal width 11.8mm rollerø 4.3mm metal		
<b>For models:</b>	EDT100, EDT140, EDT170, EDT200, EDT230, EDT85, TR100, TR140, TR170, TR200, TR230, TR90, TR-E100, TR-E150, TR-E170, TR-E200, TR-E230		

half links



1

<b>GEV No.</b>	697841	<b>Ref. No.</b>	H410902
<b>description</b>	half link single DIN/ISO 08 B-1 splitting 1/2"		
<b>For models:</b>	EDT100, EDT140, EDT170, EDT200, EDT230, EDT85, TR100, TR140, TR170, TR200, TR230, TR90, TR-E100, TR-E150, TR-E170, TR-E200, TR-E230		

springs

torsion springs



1

<b>GEV No.</b>	512017	<b>Ref. No.</b>	35870
<b>description</b>	spring ø 11mm wire gauge ø 2mm for filter		

compression springs



1

<b>GEV No.</b>	512102	<b>Ref. No.</b>	30438
<b>description</b>	compression spring		
<b>For models:</b>	60BT, 60BT-3, 60EBT, APS43, APS48, APS48B, APS53, APS60, APSE43, APSE48, APSE53, APSE60, BPN48, BPS43, BPS52, C3, C35, C4, C43, C43-2, C43ALTA, C43D, C43DE, C43E, C46DE, C46E, C48, C48-2, C48D, C48D-2, C48DDL, C48DL, C48E, C53, C53D, C53DE, C53E, C6, C60, C60D, C60DE, C60E, C68DE, C68E, C6D, C6DE, C6E, C81, C81E, C81EBT...(Other models you can see in the webshop)		

Зип Общепит

vsezip.ru

+7(812)987-08-81



1

<b>GEV No.</b>	512108	<b>Ref. No.</b>	30426
<b>description</b>	compression spring ø 4mm L 60mm wire gauge ø 2mm		
<b>For models:</b>	60EBT, AP53E, AP60E, BPS43, C3, C35E, C4, C43-2, C43ALTA, C43DE, C43E, C46DE, C46E, C48-2, C48D-2, C48DDL, C48DL, C48E, C53, C53D, C53DE, C53E, C60DE, C60E, C68DE, C68E, C68EBT, C6DE, C6E, C6EBT, DP35, DP35-2, DP35D, DP35D-2, DP40, DP40-2, DP40D, DP40D-2, DP40D-rib2, DP40-rib2, DP45, DP45D, DP45DE, DP45E, DP50DE, DP50E, DP50EBT, E40-2F, GS-X1011, GS-X1011-2...(Other models you can see in the webshop)		



1

<b>GEV No.</b>	511376	<b>Ref. No.</b>	450234
<b>description</b>	compression spring ø 6mm L 25mm wire gauge ø 0.65mm		
<b>For models:</b>	C35E, C68DE, C68E, C68EBT, C90DE2, C90E2, C90EBT2		

roller springs

roller springs



1

<b>GEV No.</b>	511663	<b>Ref. No.</b>	391318 H391318
<b>description</b>	roller spring 4.5kg complete incl. holder L 125mm W 40mm lug length 125mm		



1

<b>GEV No.</b>	511922	<b>Ref. No.</b>	H391309
<b>description</b>	roller spring 4kg complete incl. holder L 125mm W 40mm ID ømm lug length 125mm		
<b>For models:</b>	EDT100, EDT140, EDT170, EDT200, EDT230, EDT85, TR200, TR-E200, TR-E230		



1

<b>GEV No.</b>	511578	<b>Ref. No.</b>	391332 H391332
<b>description</b>	roller spring 5.5kg complete incl. holder W 40mm		
<b>For models:</b>	C98, EDT100, EDT140, EDT170, EDT200, EDT230, EDT85, HG2LR, HGLR, LO62		

Зип Общепит

<b>GEV No.</b>	512033	<b>Ref. No.</b>	34927
<b>description</b>	tension spring ø 21.6mm total length 190mm wire gauge ø 3mm L1 121.5mm		
<b>For models:</b>	EDI13, EDI13-2, EDI13ALTA, EDI13ALTA-2, EDI13ALTABT, EDI13BT, EDI4, EDI5, EDI6-2, EDI6BT, EDI8, EDI8-2, EDI8BT, HD130BT, LO134, LO134-2, LO134ALTA, LO134ALTA-2, LO56, LO67, LO67-2, LO83, LO83-2, RLO200, RLO300, RLO400		



<b>GEV No.</b>	511552	<b>Ref. No.</b>	391351 H391331
<b>description</b>	roller spring complete incl. holder W 40mm ID ømm lug length 70mm		
<b>For models:</b>	AC101, AC151, AC181, AC201, AC241, AC91, EDT100, EDT140, EDT170, EDT200, EDT230, EDT85, HG2LR, HGLR, TR100, TR140, TR170, TR200, TR230, TR90, TR-E100, TR-E150		

tension springs



<b>GEV No.</b>	512373	<b>Ref. No.</b>	25826
<b>description</b>	tension spring		
<b>For models:</b>	ED650E, ED650E-90, ED650S, ED650S-90		



<b>GEV No.</b>	512031	<b>Ref. No.</b>	36625
<b>description</b>	tension spring ø 13.5mm total length 67mm wire gauge ø 1.5mm		
<b>For models:</b>	60EBT, C53DE, C53E, C60DE, C60E, C6DE, C6E, SP50DE, SP50E, SP50E-400V3-50Hz-MARINE, SP50E-440V3-60Hz-MARINE, SP5DE, SP5E		



<b>GEV No.</b>	701045	<b>Ref. No.</b>	450222 H450222
<b>description</b>	tension spring ø 13mm total length 195mm wire gauge ø 1.2mm		



<b>GEV No.</b>	510064	<b>Ref. No.</b>	36860 450298
<b>description</b>	tension spring ø 13mm total length 78mm wire gauge ø 2.5mm L1 14mm L2 50mm L3 14mm		
<b>For models:</b>	60EBT, C60DE, C60E, C68DE, C68E, C68EBT, C6DE, C6E, C6EBT, SP50DE, SP50E, SP68DE, SP68E		



<b>GEV No.</b>	511580	<b>Ref. No.</b>	34773
<b>description</b>	tension spring ø 16.5mm total length 98mm wire gauge ø 2.5mm for dishwasher		
<b>For models:</b>	C81, C81E, C81EBT, C90, C90DE, C90E, C90EBT, LO50, LO50E, RLO50, SMW15, SMW15E, SP81, SP81E, US-X501		



<b>GEV No.</b>	510928	<b>Ref. No.</b>	33522 391316
<b>description</b>	tension spring ø 37mm total length 910mm wire gauge ø 5.3mm for hood C85/140-G75		
<b>For models:</b>	CA120, CA55, CA90, CAP10, CAP10BT, CAP10DE, CAP12, CAP12DE, CAP12EBT, CAP15EBT, CAP7, CAP7E, ED550, ED650E, ED650S, RCA1100, RCA1200, RCA1200i, SO100, SO100-400V3-50Hz-MARINE, SO100-440V3-60Hz-MARINE, SO120, SO55, SO55-400V3-50Hz-MARINE, SO55-440V3-60Hz-MARINE, SO55E		

dosing pumps



peristaltic dosing pumps

SEKO

wall-mounted version

with speed control



<b>GEV No.</b>	361907 <sup>1</sup>	<b>Ref. No.</b>	32570 38127
<b>description</b>	dosing pump SEKO speed control 1-7l/h 230VAC detergent hose ø 4x6mm hose type K hose Santoprene suction level 1.5m type PR with inlet and conveyor hose 6W cable length 2700mm set CODE PPR0007A1000_A		
<b>For models:</b>	C81E, C81EBT, C90DE2, C90E2, C90EBT, C90EBT2, C98, CAP10, CAP10BT, CAP10DE, CAP12, CAP12DE, CAP12EBT, CAP7E, ED600-95, ED700-90, ED900-90, EDI13, EDI13-2, EDI13ALTA, EDI13ALTA-2, EDI13ALTABT, EDI13BT, EDI4, EDI5, EDI6, EDI6-2, EDI6BT, EDI8, EDI8-2, EDI8BT, HD130BT, HD40ALTABT, HD40BT, HD60BT, HD80BT, LO122, LO134, LO134-2, LO134ALTA, LO134ALTA-2, LO56, LO60, LO61, LO62, LO67, LO67-2, LO78, LO83, LO83-2...(Other models you can see in the webshop)		
<b>spare parts for</b>	361907		
	<b>GEV No.</b>	361815	<b>Ref. No.</b> 35137
	pump hose detergent hose ø 6x10mm hose ø 4x6mm hose type K hose Santoprene type SEKO		
	<b>GEV No.</b>	361909	<b>Ref. No.</b> 34024
	hose connector for dosing pump connection 6x4 grommet ø 7mm grommet length 19mm total length 35mm plastic		

<sup>1</sup>with accessories



3ип Общежит  
membrane dosing pumps

self-priming  
various

+7(812)987-08-81

built-in version

with frequency control



<b>GEV No.</b>	361906 <sup>1</sup>	<b>Ref. No.</b>	34358
<b>description</b>	dosing pump SEKO frequency control 2.8l/h 230VAC detergent hose ø 4x6mm hose Santoprene type NBR 3 8W CODE NBR0003A1004		
<b>For models:</b>	60BT, 60BT-3, 60EBT, AP43E, AP48E, AP53E, AP60E, C35E, C43DE, C43E, C46DE, C46E, C53DE, C53E, C60DE, C60E, C68DE, C68E, C68EBT, C6DE, C6E, C6EBT, CAP7E, DP45DE, DP45E, DP50DE, DP50E, FW35E, FW40E, GS-X1021, GS-X1021-2, GS-X1021-2rib, GS-X1021-WEH, GS-X1021-WEH-2, GS-X1021-WEH-2rib, SD5BT, SP35DE, SP35E, SP40DE, SP40E, SP45DE, SP45E, SP50DE, SP50E, SP50E-400V3-50Hz-MARINE, SP50E-440V3-60Hz-MARINE, SPB35E, ST43DE, ST43E, ST48DE...(Other models you can see in the webshop)		

<sup>1</sup>with accessories

spare parts



<b>GEV No.</b>	361815	<b>Ref. No.</b>	35137
<b>description</b>	pump hose detergent hose ø 6x10mm hose ø 4x6mm hose type K hose Santoprene type SEKO		
<b>For models:</b>	60BT, 60BT-3, 60EBT, AP43E, AP48E, AP53E, AP60E, C35E, C43DE, C43E, C46DE, C46E, C53DE, C53E, C60DE, C60E, C68DE, C68E, C68EBT, C6DE, C6E, C81E, C81EBT, C90DE2, C90E2, C90EBT, C90EBT2, C98, CAP10, CAP10BT, CAP10DE, CAP12, CAP12DE, CAP12EBT, CAP7E, DP45DE, DP45E, DP50DE, DP50E, EDI13, EDI13-2, EDI13ALTA, EDI13ALTA-2, EDI13ALTABT, EDI13BT, EDI4, EDI5, EDI6, EDI6-2, EDI6BT...(Other models you can see in the webshop)		

miscellaneous



<b>GEV No.</b>	361909	<b>Ref. No.</b>	34024
<b>description</b>	hose connector for dosing pump connection 6x4 grommet ø 7mm grommet length 19mm total length 35mm plastic		
<b>For models:</b>	EDI13, EDI13-2, EDI13ALTA, EDI13ALTA-2, EDI4, EDI6, EDI6-2, EDI8, EDI8-2, HD130BT, HD40ALTABT, HD40BT, HD60BT, HD80BT, LO134, LO134-2, LO134ALTA, LO134ALTA-2, LO56, LO67, LO67-2, LO83, LO83-2		



<b>GEV No.</b>	361002	<b>Ref. No.</b>	620120 H620120
<b>description</b>	dosing pump rinse aid inlet 6x8mm outlet 4x6mm pressure connection ø 4x6mm suction connection ø 6x8mm		
<b>spare parts for</b>	361002		
<b>GEV No.</b>	510297	<b>Ref. No.</b>	H630614
<b>description</b>	membrane for dosing pump ED ø 83mm thickness 1mm dosing pump equiv. no. 630614 suitable for COMENDA		
<b>GEV No.</b>	510298	<b>Ref. No.</b>	—
<b>description</b>	lip valve dosing pump suitable for DB2/DS5		
<b>GEV No.</b>	510299	<b>Ref. No.</b>	—
<b>description</b>	hose connector for dosing pump		
<b>GEV No.</b>	510338	<b>Ref. No.</b>	—
<b>description</b>	union nut dosing pump thread 1/2" ø 32mm H 15mm for dosing pump		
<b>GEV No.</b>	510847	<b>Ref. No.</b>	—
<b>description</b>	gasket polishing agent dosing ID ø 22mm ED ø 32mm external height 5mm		
<b>GEV No.</b>	510870	<b>Ref. No.</b>	H191018
<b>description</b>	filter support for dosing pump		
<b>GEV No.</b>	510916	<b>Ref. No.</b>	—
<b>description</b>	filter for dosing pump		

spare parts



<b>GEV No.</b>	510870	<b>Ref. No.</b>	H191018
<b>description</b>	filter support for dosing pump		







<b>GEV No.</b>	510297	<b>Ref. No.</b>	H630614
<b>description</b>	membrane for dosing pump ED ø 83mm thickness 1mm dosing pump equiv. no. 630614 suitable for COMENDA		



self-priming with supporting pressure

HOONVED



<b>GEV No.</b>	361010	<b>Ref. No.</b>	20007 20008 21428 21560 21729 21951 22060
<b>description</b>	dosing pump rinse aid pressure connection ø 4x6mm suction connection ø 4mm auxiliary pressure connection 10mm HOONVED		
<b>For models:</b>	60BT, 60BT-3, 60EBT, APS43, APS48, APS48B, APS53, APS60, APSE43, APSE48, APSE60, C3, C35, C4, C43, C43ALTA, C43D, C48, C48D, C48DDL, C48DL, C53, C53D, C60, C60D, C68EBT, C6EBT, C81, C81EBT, C90, C90DE2, C90EBT, C90EBT2, CA120, CA55, CA90, CAP10BT, CAP12EBT, CDN3, CDN4, CM43, CM48, CM52, CM60, CMD43, CMD48, CMD52, CMD60, CR43, CR43D...(Other models you can see in the webshop)		
<b>spare parts for</b>	361010		
	<b>GEV No.</b>	<b>Ref. No.</b>	25211
	lip valve rinse aid pressure connection ømm suction connection ømm auxiliary pressure connectionmm		
	<b>GEV No.</b>	<b>Ref. No.</b>	31596 630632
	membrane rinse aid pressure connection ømm suction connection ømm auxiliary pressure connectionmm		
<b>accessories for</b>	361010		
	<b>GEV No.</b>	<b>Ref. No.</b>	—
	PVC hose ID ø 4mm ED ø 6mm L 2m thickness 1mm t.max. 60°C transparent		
	<b>GEV No.</b>	<b>Ref. No.</b>	—
	nylon hose ID ø 4mm ED ø 6mm L 2m thickness 1mm operating p. 10bar burst p. 50bar t.max. 100°C transparent		





<b>GEV No.</b>	361908	<b>Ref. No.</b>	35991 620736V01
<b>description</b>	dosing pump rinse aid pressure connection ø 7mm suction connection ø 5mm auxiliary pressure connection 10mm		
<b>For models:</b>	AP43E, AP48E, C35E, C43DE, C43E, C46DE, C46E, C90E2, FW35E, FW40E, SP35DE, SP35E, SP40DE, SP40E		

Зип Общепит



+7(812)987-08-81

<b>GEV No.</b>	361387	<b>Ref. No.</b>	35388
<b>description</b>	dosing pump rinse aid pressure connection ø 8mm suction connection ø 4mm auxiliary pressure connection 10mm		
<b>For models:</b>	60BT, AP53E, AP60E, C35, C43-2, C48-2, C48D-2, C48E, C53DE, C53E, C6, C60DE, C60E, C68DE, C68E, C6D, C6DE, C6E, C81E, C90, C90DE, C90DE2, C90E, C98, CAP10, CAP10DE, CAP12, CAP12DE, CAP7, CAP7E, CDN3, CDN4, DP35-2, DP35D-2, DP40-2, DP40D-2, DP40D-rib2, DP40-rib2, DP45DE, DP45E, DP50DE, DP50E, EDI13, EDI13-2, EDI13ALTA, EDI13ALTA-2, EDI5, EDI6, EDI6-2, EDI8...(Other models you can see in the webshop)		
<b>spare parts for</b>	361387		
	<b>GEV No.</b>	<b>Ref. No.</b>	25211
	lip valve rinse aid pressure connection ømm suction connection ømm auxiliary pressure connectionmm		
	<b>GEV No.</b>	<b>Ref. No.</b>	31596 630632
	membrane rinse aid pressure connection ømm suction connection ømm auxiliary pressure connectionmm		
	<b>GEV No.</b>	<b>Ref. No.</b>	—
	O-ring EPDM thickness 2.62mm ID ø 15.88mm Qty 1 pcs		
<b>accessories for</b>	361387		
	<b>GEV No.</b>	<b>Ref. No.</b>	—
	PVC hose ID ø 8mm ED ø 12mm L 10m thickness 2mm t.max. 60°C transparent		
	<b>GEV No.</b>	<b>Ref. No.</b>	—
	PVC hose ID ø 4mm ED ø 6mm L 2m thickness 1mm t.max. 60°C transparent		



<b>GEV No.</b>	361383	<b>Ref. No.</b>	25211
<b>description</b>	lip valve rinse aid pressure connection ømm suction connection ømm auxiliary pressure connectionmm		
<b>For models:</b>	60BT, 60BT-3, 60EBT, AP43E, AP48E, AP53E, AP60E, APS43, APS48, APS48B, APS53, APS60, APSE43, APSE48, APSE53, APSE60, BPN48, BPS43, BPS52, C3, C35, C35E, C4, C43, C43-2, C43ALTA, C43D, C43DE, C43E, C46DE, C46E, C48, C48-2, C48D, C48D-2, C48DDL, C48DL, C48E, C53, C53D, C53DE, C53E, C6, C60, C60D, C60DE, C60E, C68DE, C68E, C68EBT...(Other models you can see in the webshop)		



<b>GEV No.</b>	361384	<b>Ref. No.</b>	31596 630632
<b>description</b>	membrane rinse aid pressure connection ømm suction connection ømm auxiliary pressure connectionmm		
<b>For models:</b>	60BT, 60BT-3, 60EBT, AP43E, AP48E, AP53E, AP60E, APS43, APS48, APS48B, APS53, APS60, APSE43, APSE48, APSE53, APSE60, C3, C35, C35E, C4, C43, C43-2, C43ALTA, C43D, C43DE, C43E, C46DE, C46E, C48, C48-2, C48D, C48D-2, C48DDL, C48DL, C48E, C53, C53D, C53DE, C53E, C6, C60, C60D, C60DE, C60E, C68DE, C68E, C68EBT, C6D, C6DE, C6E...(Other models you can see in the webshop)		



electronic controllers





<b>GEV No.</b>	361831	<b>Ref. No.</b>	31822
<b>description</b>	conductivity meter GICAR type 8.5.01.56		
<b>For models:</b>	ED600-95, ED700-90, ED900-90, LO122, LO60, LO78		

accessories

T-pieces

without non-return valve



<b>GEV No.</b>	512093	<b>Ref. No.</b>	33817
<b>description</b>	T-piece connection 1: 12mm connection 2: 4mm		
<b>For models:</b>	C35, C43, C43ALTA, C43D, C48, C48D, C48DDL, C48DL, C53, C53D, C60, C60D, C81, C90, CA120, CA55, CA90, CR43, CR43D, CR48, CR48D, DP35, DP35D, DP40, DP40D, DP45, DP45D, DP50, DP50D, DP50D-115V, ED550, ED650E, ED650S, GS-X1011, GS-X1011-WEH, GS-X1021, GS-X1021-WEH, LO50, RCA1100, RCA1200, RCA1200i, RLO50, SP35, SP35ALTA, SP35D, SP40, SP40D, SP40DDL, SP40DL, SP45...(Other models you can see in the webshop)		
<b>accessories for</b>	512093		
	<b>GEV No.</b>	361083	<b>Ref. No.</b>
			—
	union nut T1: M10x1 for hose 6mm		

tank inlets



<b>GEV No.</b>	361270	<b>Ref. No.</b>	H251213
<b>description</b>	tank inlet SS M12 hose ø 4mm		
<b>For models:</b>	60EBT, AP43E, AP48E, C43DE, C43E, C46DE, C46E, C53DE, C53E, C60DE, C60E, C68DE, C68E, C68EBT, C6DE, C6E, C81E, C90DE2, C90E2, C90EBT, C90EBT2, C98, CAP10, CAP10BT, CAP12, CAP7E, EDI13, EDI13-2, EDI13ALTA, EDI13ALTA-2, EDI4, EDI6, EDI6-2, EDI8, EDI8-2, FW35E, FW40E, LO134-2, LO134ALTA-2, LO62, LO67-2, LO83-2, SMW15E, SO100, SO100-400V3-50Hz-MARINE, SO100-440V3-60Hz-MARINE, SO120, SO55E, SP35DE, SP35E...(Other models you can see in the webshop)		

Зип-Общепит hoses

supply hoses

PVC supply hoses



<b>GEV No.</b>	520631	<b>Ref. No.</b>	25235
<b>description</b>	supply hose PVC straight-straight DN13 connections 3/4" L 1500mm operating p. 10bar burst p. 32bar t.max. 90°C approval VDE flat seal		
<b>For models:</b>	APS43, APS48, APS48B, APS53, APS60, APSE43, APSE48, APSE53, APSE60, BPN48, BPS43, BPS52, C3, C35, C4, C43, C43-2, C43ALTA, C43D, C43DE, C43E, C46DE, C46E, C48, C48-2, C48D, C48D-2, C48DDL, C48DL, C48E, C53, C53D, C53DE, C53E, C6, C60, C60D, C60DE, C60E, C68DE, C68E, C6D, C6DE, C6E, C81, C81E, C90, C90E, CA55, CAP7...(Other models you can see in the webshop)		

drain hoses



<b>GEV No.</b>	530587	<b>Ref. No.</b>	24044 27110
<b>description</b>	drain hose DN28 L 2000mm straight ø inside 32mm straight ext. ø 40mm outer hose ø 35mm		
<b>For models:</b>	C81, C81E, C81EBT, C90, C90DE, C90DE2, C90E, C90E2, C90EBT, C90EBT2, C98, CA120, CA55, CA90, CAP10, CAP10BT, CAP10DE, CAP12, CAP12DE, CAP12EBT, CAP7, CAP7E, ED550, ED600-95, ED630-90, ED650E, ED650E-90, ED650S, ED650S-90, ED700-90, ED900-90, EDI13, EDI13-2, EDI13ALTA, EDI13ALTA-2, EDI13ALTABT, EDI13BT, EDI4, EDI5, EDI6, EDI6-2, EDI6BT, EDI8, EDI8-2, EDI8BT, HD130BT, HD40ALTABT, HD40BT, HD60BT, HD80BT...(Other models you can see in the webshop)		

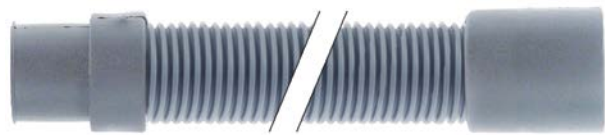

<b>GEV No.</b>	530607	<b>Ref. No.</b>	200779 34106
<b>description</b>	drain hose DN24 L 2000mm A int. ø 24mm A ext. ø 28mm B int. ø 28mm B ext. ø 35mm outer hose ø 29mm temp.-resist. 90°C		
<b>For models:</b>	C35E, C43DE, C43E, C46DE, C46E, SP35DE, SP35E, SP40DE, SP40E, SPB35E, ST48EBT		



Зип Общепит  
Industrial hoses

Niplaflex hoses  
vsezip.ru

+7(812)987-08-81



1

<b>GEV No.</b>	530616	<b>Ref. No.</b>	27078
<b>description</b>	drain hose L 1500mm A int. ø 25mm B int. ø 25mm outer hose ø 32mm		
<b>For models:</b>	60BT, 60BT-3, 60EBT, C3, C4, C53, C53D, C53DE, C53E, C6, C60, C60D, C60DE, C60E, C68DE, C68E, C68EBT, C6D, C6DE, C6E, C6EBT, C98, CM43, CM48, CM52, CM60, CMD43, CMD48, CMD52, CMD60, DP45, DP45D, DP45DE, DP45E, DP50, DP50D, DP50D-115V, DP50DE, DP50E, DP50EBT, E36, E40, E40-2F, E43, E50, INDY43F, INDY48F, LO62, M60, NK43...(Other models you can see in the webshop)		



1

<b>GEV No.</b>	506207	<b>Ref. No.</b>	27386
<b>description</b>	drain hose DN19 L 1500mm straight ø inside 19mm straight ext. ø 24mm elbow ø inside 21mm elbow ext. ø 27mm outer hose ø 25mm		
<b>For models:</b>	60EBT, AP43E, AP48E, APS43, APS48, APS48B, APS53, APS60, APSE43, APSE48, APSE53, APSE60, BPN48, BPS43, BPS52, C35E, C43DE, C43E, C46DE, C46E, C53DE, C53E, C60DE, C60E, C68DE, C68E, C6DE, C6E, FW35, FW35E, FW40, FW40B, FW40E, FW45, FW50, SP35DE, SP35E, SP40DE, SP40E, SP45DE, SP45E, SP50DE, SP50E, SP50E-400V3-50Hz-MARINE, SP50E-440V3-60Hz-MARINE, SP5DE, SP5E, SP68DE, SP68E, SPB35E...(Other models you can see in the webshop)		



1

<b>GEV No.</b>	530613	<b>Ref. No.</b>	200346 34106
<b>description</b>	drain hose DN19 L 3000mm straight ø inside 21mm straight ext. ø 27mm elbow ø inside 21mm elbow ext. ø 27mm outer hose ø 20mm		
<b>For models:</b>	C35, C35E, C43, C43-2, C43ALTA, C43D, C43DE, C43E, C46DE, C46E, C48, C48-2, C48D, C48D-2, C48DDL, C48DL, C48E, CAP15EBT, CDN3, CDN4, CR43, CR43D, CR48, CR48D, DP35, DP35-2, DP35D, DP35D-2, DP40, DP40-2, DP40D, DP40D-2, DP40D-rib2, DP40-rib2, EDI13, EDI13ALTA, EDI6, EDI8, GS-X1011, GS-X1011-2, GS-X1011-WEH, GS-X1011-WEH-2, GS-X1021, GS-X1021-2, GS-X1021-2rib, GS-X1021-WEH, GS-X1021-WEH-2, GS-X1021-WEH-2rib, LO134, LO134ALTA...(Other models you can see in the webshop)		



1

<b>GEV No.</b>	530561	<b>Ref. No.</b>	00182 200122 H200122
<b>description</b>	pressure hose ID ø 10mm ED ø 17mm L 5m thickness 3.5mm operating p. 10bar burst p. 30bar t.max. 110°C		
<b>For models:</b>	60BT, 60BT-3, 60EBT, AP43E, AP48E, AP53E, AP60E, APS43, APS48, APS48B, APS53, APS60, APSE43, APSE48, APSE53, APSE60, BPS43, C3, C35, C35E, C4, C43, C43-2, C43ALTA, C43D, C43DE, C43E, C46DE, C46E, C48, C48-2, C48D, C48D-2, C48DDL, C48DL, C48E, C53, C53D, C53DE, C53E, C6, C60, C60D, C60DE, C60E, C68DE, C68E, C68EBT, C6D, C6DE...(Other models you can see in the webshop)		

pressure control hoses



1

<b>GEV No.</b>	530560	<b>Ref. No.</b>	00181 H160121
<b>description</b>	pressure control hose ID ø 5mm ED ø 9mm L 5m operating p. 30bar burst p. 90bar temp.-resist. 60°C		
<b>For models:</b>	60BT, 60BT-3, 60EBT, APS43, APS48, APS48B, APS53, APS60, APSE43, APSE48, APSE53, APSE60, BPN48, BPS43, BPS52, C3, C35, C35E, C4, C43, C43-2, C43ALTA, C43D, C43DE, C43E, C46DE, C46E, C48, C48-2, C48D, C48D-2, C48DDL, C48DL, C48E, C53, C53D, C53DE, C53E, C6, C60, C60D, C60DE, C60E, C68DE, C68E, C68EBT, C6D, C6DE, C90DE...(Other models you can see in the webshop)		

formed hoses

straight



1

<b>GEV No.</b>	512133	<b>Ref. No.</b>	33949
<b>description</b>	formed hose D1 ø 43mm D2 ø 37mm L 141mm dishwasher straight		
<b>For models:</b>	C53, C53D, DP45, DP45D, SP45, SP45D, STS53, STS53D, TN-TDN5, TN-TDN6		





Зип Общепит  
vsezip.ru

+7(812)987-08-81



1

<b>GEV No.</b>	511362	<b>Ref. No.</b>	33455
<b>description</b>	formed hose dishwasher straight equiv. no. 200758		
<b>For models:</b>	CA120, CA55, CA90, CAP7, CAP7E, ED550, ED650E, ED650S, RCA1100, RCA1200, RCA1200i, SO55, SO55-400V3-50Hz-MARINE, SO55-440V3-60Hz-MARINE, SO55E		



1

<b>GEV No.</b>	506412	<b>Ref. No.</b>	200105 H200105
<b>description</b>	formed hose dishwasher straight hose ext. ø 60mm hose int. ø 50mm		
<b>For models:</b>	AC101, AC181, AC201, AC241, AC91, EDT100, EDT140, EDT170, EDT200, EDT230, EDT85, TR100, TR140, TR170, TR200, TR230, TR90, TR-E100, TR-E150, TR-E170, TR-E200, TR-E230, TR-E90		



1

<b>GEV No.</b>	511366	<b>Ref. No.</b>	200759 H200759
<b>description</b>	formed hose dishwasher straight equiv. no. 200759		
<b>For models:</b>	60BT, C81EBT, C90EBT, CAP10BT, CAP12EBT, CAP15EBT, EDT100, EDT140, EDT170, EDT200, EDT230, EDT85, HD130BT, HD60BT, HD80BT, HTP195, HTP205, HTP220, SD5BT, TR100, TR140, TR170, TR200, TR230, TR90, TR-E100, TR-E150, TR-E170		

form L



1

<b>GEV No.</b>	530054	<b>Ref. No.</b>	200767 H200767
<b>description</b>	formed hose		



1

<b>GEV No.</b>	512359	<b>Ref. No.</b>	32055
<b>description</b>	formed hose dishwasher straight equiv. no. 32055		
<b>For models:</b>	APS43, APS48, APS48B, APS53, APS60, APSE43, APSE48, APSE53, APSE60, FW35, FW40, FW40B, FW45, FW50		



1

<b>GEV No.</b>	524821	<b>Ref. No.</b>	36028
<b>description</b>	formed hose end piece A ext. ø 35mm end piece A int. ø 27mm AD2 ø 35mm ø end piece B 27mm L 145mm Qty 1 warewashing L-shape		
<b>For models:</b>	60BT-3, 60EBT, C68EBT, C6EBT, C90EBT, C90EBT2, CAP10BT, CAP12EBT, DP50EBT, EDI4, LOS6, SD5BT, ST48EBT, ST60EBT		



1

<b>GEV No.</b>	512363	<b>Ref. No.</b>	32880
<b>description</b>	formed hose dishwasher straight equiv. no. 32880		
<b>For models:</b>	C3, C4		



1

<b>GEV No.</b>	512358	<b>Ref. No.</b>	30014
<b>description</b>	formed hose end piece A ext. ø 53mm end piece A int. ø 39mm AD2 ø 58mm ø end piece B 45mm warewashing L-shape equiv. no. 30014 L1 150mm L2 90mm		
<b>For models:</b>	APS60, APSE60, FW50		



1

<b>GEV No.</b>	512365	<b>Ref. No.</b>	33541
<b>description</b>	formed hose dishwasher straight equiv. no. 35498		
<b>For models:</b>	C43ALTA, C48DDL, C48DL, DP35, DP35D, DP40, DP40D, GS-X1011, GS-X1011-WEH, GS-X1021, GS-X1021-WEH, SP35ALTA, SP40DDL, SP40DL, STS43, STS43D, STS48, STS48D		



Зип Общепит

vsezip.ru

+7(812)987-08-81

			
1			
<b>GEV No.</b>	512364	<b>Ref. No.</b>	H201029
<b>description</b>	formed hose end piece A ext. ø 60mm end piece A int. ø 45mm AD2 ø 45mm ø end piece B 29mm warewashing L-shape equiv. no. H201029		
<b>For models:</b>	DP35-2, DP35D-2, DP40-2, DP40D-2, GS-X1021-2, GS-X1021-2rib, GS-X1021-WEH-2, GS-X1021-WEH-2rib, STS43-2, STS43D-2, STS48-2, STS48D-2, TDN4-2rib		

			
1			
<b>GEV No.</b>	530577	<b>Ref. No.</b>	33454
<b>description</b>	formed hose L 350mm warewashing L-shape equiv. no. 200750 ID ø 60mm		
<b>For models:</b>	CA120, CA55, CA90, CAP7, CAP7E, ED550, ED650E, ED650S, RCA1100, RCA1200, RCA1200i, SO55, SO55-400V3-50Hz-MARINE, SO55-440V3-60Hz-MARINE, SO55E		

			
1			
<b>GEV No.</b>	524515	<b>Ref. No.</b>	25225
<b>description</b>	formed hose end piece A ext. ø 75mm end piece A int. ø 58mm AD2 ø 75mm ø end piece B 59mm inlet hose warewashing L-shape Qty 1 black L2 155mm L1 160mm		
<b>For models:</b>	ED600-95, ED650S, ED700, ED900, EDI5, K80F, K80G, LO60, LO61		

			
1			
<b>GEV No.</b>	512134	<b>Ref. No.</b>	33743
<b>description</b>	formed hose warewashing L-shape		
<b>For models:</b>	C35, C43, C43D, C48, C48D, CDN3, CDN4, CR43, CR43D, CR48, CR48D, SP35, SP35D, SP40, SP40D, SPB35, SPR36, SPR36D, SPR41, SPR41D		

			
1			
<b>GEV No.</b>	512129	<b>Ref. No.</b>	29532
<b>description</b>	formed hose end piece A ext. ø 75mm end piece A int. ø 59mm AD2 ø 75mm ø end piece B 59mm warewashing L-shape equiv. no. 29532		
<b>For models:</b>	C81, C81E, C81EBT, C90, C90DE, C90E, C90EBT, C98, ED650E, ED650E-90, ED650S-90, ED700-90, LO50, LO50E, LO62, LO78, RLO50, SMW15, SMW15E, SP81, SP81E, US-X501		

			
1			
<b>GEV No.</b>	512381	<b>Ref. No.</b>	200612 36296
<b>description</b>	formed hose warewashing L-shape		
<b>For models:</b>	60EBT, AP53E, AP60E, C53DE, C53E, C60DE, C60E, C68DE, C68E, C68EBT, C6DE, C6E, C6EBT, DP45DE, DP45E, DP50DE, DP50E, DP50EBT, SP45DE, SP45E, SP50DE, SP50E, SP50E-400V3-50Hz-MARINE, SP50E-440V3-60Hz-MARINE, SP5DE, SP5E, SP68DE, SP68E, ST53DE, ST53E, ST60DE, ST60E, ST60EBT		

			
1			
<b>GEV No.</b>	512135	<b>Ref. No.</b>	32984
<b>description</b>	formed hose end piece A int. ø 51mm ø end piece B 52mm L 460mm warewashing L-shape W 150mm		
<b>For models:</b>	C81, C90, ED600-95, EDI5, LO60, LO61, SP81		

			
1			
<b>GEV No.</b>	511365	<b>Ref. No.</b>	201017 H201017
<b>description</b>	formed hose warewashing L-shape equiv. no. 201017		
<b>For models:</b>	60BT, 60BT-3, 60EBT, C68EBT, C6EBT, DP50EBT, SD5BT, ST48EBT, ST60EBT		





Зип Общепит

vsezip.ru

+7(812)987-08-81

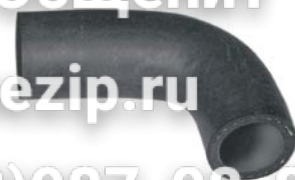
			
1			
<b>GEV No.</b>	512362	<b>Ref. No.</b>	25223
<b>description</b>	formed hose warewashing L-shape equiv. no. 25223		
<b>For models:</b>	M60, T5-80, T6-80		

			
1			
<b>GEV No.</b>	512131	<b>Ref. No.</b>	32881
<b>description</b>	formed hose warewashing L-shape equiv. no. 32881		
<b>For models:</b>	C3, C4, C43, C43D, C48, C48D, CR43, CR43D, CR48, CR48D, SP35, SP35D, SP40, SP40D, SPR36, SPR36D, SPR41, SPR41D		

			
1			
<b>GEV No.</b>	512356	<b>Ref. No.</b>	26907
<b>description</b>	formed hose warewashing L-shape equiv. no. 26907		
<b>For models:</b>	APS48, APS48B, APS53, APSE48, APSE53, CM48, CMD48, FW40, FW40B, FW45, NK48, NKD48, T3-80, T4-80, T5-80, T6-80, UNI48R, UNI48RD		

			
1			
<b>GEV No.</b>	512357	<b>Ref. No.</b>	33767
<b>description</b>	formed hose warewashing L-shape equiv. no. 33767		
<b>For models:</b>	APS43, APS48, APS48B, APS53, APS60, APSE43, APSE48, APSE53, FW35, FW40, FW40B, FW45, FW50		

			
1			
<b>GEV No.</b>	512355	<b>Ref. No.</b>	26909
<b>description</b>	formed hose warewashing L-shape equiv. no. 26909		
<b>For models:</b>	APS43, APS48B, APSE43, E50, FW35, FW40B, M60		

			
1			
<b>GEV No.</b>	512366	<b>Ref. No.</b>	35454
<b>description</b>	formed hose warewashing L-shape equiv. no. 35454		
<b>For models:</b>	C43-2, C48-2, C48D-2, C48E, DP40D-rib2, DP40-rib2, GS-X1011-2, GS-X1011-WEH-2, RSP40, RSP40A, SP35-2, SP40-2, SP40D-2, SP40E, ST43DE, ST43E, ST48DE, ST48E, STS48D-rib2, STS48-rib2, TDN4-2rib		

			
1			
<b>GEV No.</b>	512361	<b>Ref. No.</b>	28421
<b>description</b>	formed hose warewashing L-shape equiv. no. 28421		
<b>For models:</b>	T3-80, T4-80		

			
1			
<b>GEV No.</b>	512367	<b>Ref. No.</b>	H201030
<b>description</b>	formed hose warewashing L-shape equiv. no. H201030		
<b>For models:</b>	C43-2, C48-2, GS-X1011-2, GS-X1011-WEH-2, GS-X1021-2, GS-X1021-2rib, GS-X1021-WEH-2, GS-X1021-WEH-2rib, SP35-2, SP40-2, TDN4-2rib		

			
1			
<b>GEV No.</b>	512118	<b>Ref. No.</b>	31236
<b>description</b>	formed hose warewashing L-shape equiv. no. 31236		
<b>For models:</b>	TS48, UNI48C, UNI48CD		

			
1			
<b>GEV No.</b>	512380	<b>Ref. No.</b>	201059 35498
<b>description</b>	pressure hose L-shape		
<b>For models:</b>	C35E, C43-2, C43DE, C43E, C46DE, C46E, C48-2, C48D-2, C48E, DP35-2, DP35D-2, DP40-2, DP40D-2, DP40D-rib2, DP40-rib2, RSP40, RSP40A, SP35-2, SP35DE, SP35E, SP40-2, SP40D-2, SP40DE, SP40E, ST43DE, ST43E, ST48DE, ST48E, ST48EBT, STS43-2, STS43D-2, STS48-2, STS48D-2, STS48D-rib2, STS48-rib2, TDN4-2rib		



Зип Ощепит

vsezip.ru

+7(812)987-08-81

with branch



<b>GEV No.</b>	511208	<b>Ref. No.</b>	200768
<b>description</b>	formed hose warewashing equiv. no. 200768 with piggyback		



<b>GEV No.</b>	512130	<b>Ref. No.</b>	25227
<b>description</b>	formed hose ID ø 50mm S-shape warewashing equiv. no. 25227		
<b>For models:</b>	C90DE2, C90E2, C90EBT2, ED630-90, ED650E, ED650E-90, ED650S, ED650S-90, EDI4, HD40ALTABT, HD40BT, K80F, K80G, LO56		



<b>GEV No.</b>	512132	<b>Ref. No.</b>	33583
<b>description</b>	formed hose warewashing U-shape		
<b>For models:</b>	60BT, 60BT-3, C53, C53D, C60, C60D, DP45, DP45D, DP50, DP50D, DP50D-115V, RSP50, RSP50A, SD5BT, SP45, SP45D, SP50, SP50-400V, SP50-440V, SP50D, STS53, STS53D, STS60, STS60D, TN-TDN5, TN-TDN6, VS-X313, VS-X313-LP-DOS, VS-X515, VS-X515-LP-DOS		



<b>GEV No.</b>	512120	<b>Ref. No.</b>	30453
<b>description</b>	formed hose S-shape warewashing equiv. no. 30453		
<b>For models:</b>	UNI60C		

form S



<b>GEV No.</b>	511479	<b>Ref. No.</b>	201004 H201004
<b>description</b>	formed hose hose ext. ø 65mm hose int. ø 50mm S-shape		
<b>For models:</b>	AC101, AC151, AC181, AC201, AC241, AC91, EDT100, EDT140, EDT170, EDT200, EDT230, EDT85		



<b>GEV No.</b>	512119	<b>Ref. No.</b>	30460
<b>description</b>	formed hose S-shape warewashing equiv. no. 30460		
<b>For models:</b>	UNI53C		



<b>GEV No.</b>	512360	<b>Ref. No.</b>	30466
<b>description</b>	formed hose S-shape warewashing equiv. no. 30466		
<b>For models:</b>	UNI60C		



Зип Общежит

miscellaneous

vsezip.ru

+7(812)987-08-81



1

<b>GEV No.</b>	512123	<b>Ref. No.</b>	31150
<b>description</b>	formed hose S-shape warewashing equiv. no. 31150		
<b>For models:</b>	UNI53C		



1

<b>GEV No.</b>	512121	<b>Ref. No.</b>	31193
<b>description</b>	formed hose warewashing equiv. no. 31193		
<b>For models:</b>	E40-2F, TS43, UNI43C		

form U



1

<b>GEV No.</b>	512388	<b>Ref. No.</b>	37630
<b>description</b>	formed hose D1 ø 30mm D2 ø 34mm L 540mm Qty 1		
<b>For models:</b>	AP43E, AP48E, FW35E, FW40E		



1

<b>GEV No.</b>	512117	<b>Ref. No.</b>	31194
<b>description</b>	formed hose warewashing equiv. no. 31194		
<b>For models:</b>	E40-2F, TS43, UNI43C		



1

<b>GEV No.</b>	512032	<b>Ref. No.</b>	200611 36295
<b>description</b>	formed hose D1 ø 30mm D2 ø 37mm L 645mm Qty 1		
<b>For models:</b>	60EBT, C53DE, C53E, C60DE, C60E, C68E, C6DE, C6E, C6EBT, DP45DE, DP45E, DP50DE, DP50E, DP50EBT, SP45DE, SP45E, SP50DE, SP50E, SP50E-400V3-50Hz-MARINE, SP50E-440V3-60Hz-MARINE, SP5DE, SP5E, SP68E, ST53DE, ST53E, ST60DE, ST60E, ST60EBT		

for dishwashers

miscellaneous



1

<b>GEV No.</b>	530590	<b>Ref. No.</b>	200117 H200117
<b>description</b>	hose ED ø 15mm ID ø 8mm equiv. no. 200117 Qty supplied by meter		
<b>For models:</b>	60BT, 60BT-3, 60EBT, AP43E, AP48E, AP53E, AP60E, C35, C35E, C43-2, C43DE, C43E, C46DE, C46E, C48-2, C48D-2, C48E, C53DE, C53E, C6, C60DE, C60E, C68DE, C68E, C68EBT, C6D, C6DE, C6E, C6EBT, C81E, C81EBT, C90, C90DE, C90DE2, C90E, C90E2, C90EBT, C90EBT2, C98, CAP10, CAP10BT, CAP10DE, CAP12, CAP12DE, CAP12EBT, CAP15EBT, CAP7, CAP7E, CDN3, CDN4...(Other models you can see in the webshop)		



1

<b>GEV No.</b>	512132	<b>Ref. No.</b>	33583
<b>description</b>	formed hose warewashing U-shape		
<b>For models:</b>	60BT, 60BT-3, C53, C53D, C60, C60D, DP45, DP45D, DP50, DP50D, DP50D-115V, RSP50, RSP50A, SD5BT, SP45, SP45D, SP50, SP50-400V, SP50-440V, SP50D, STS53, STS53D, STS60, STS60D, TN-TDN5, TN-TDN6, VS-X313, VS-X313-LP-DOS, VS-X515, VS-X515-LP-DOS		



1



<b>GEV No.</b>	530589	<b>Ref. No.</b>	200113 H200113
<b>description</b>	hose ED ø 22mm ID ø 12mm L 1000mm		
<b>For models:</b>	AC101, AC151, AC181, AC201, AC241, AC91, EDT100, EDT140, EDT170, EDT200, EDT230, EDT85, HG2LR, HGLR, TR100, TR140, TR200, TR230, TR90, TR-E100, TR-E150, TR-E170, TR-E200, TR-E230, TR-E90		

Зип Общепит

vsezip.ru

+7(812)987-08-81

			
1			
<b>GEV No.</b>	512036	<b>Ref. No.</b>	31913
<b>description</b>	hose int. ø 1 14mm int. ø 2 18mm		
<b>For models:</b>	INDY48F, UNI48C, UNI48CD		

			
1			
<b>GEV No.</b>	512035	<b>Ref. No.</b>	37918 37918+28224
<b>description</b>	double nipple brass thread 1/2" - 3/4" Qty 1 pcs L1 7mm L2 19mm		
<b>spare parts for</b>	512035		
	<b>GEV No.</b>	517045	<b>Ref. No.</b> 28224
	O-ring EPDM thickness 1.78mm ID ø 21.95mm Qty 1 pcs		

## fittings, hose and pipe connectors

### hose connectors

#### without screw connection

			
1			
<b>GEV No.</b>	510842	<b>Ref. No.</b>	180403
<b>description</b>	T-piece plastic hose ø 13-13-13mm 3-way		
<b>For models:</b>	AC101, AC151, AC181, AC201, AC241, AC91, EDT100, EDT140, EDT170, EDT200, EDT230, EDT85, HG2LR, HGLR		

			
1			
<b>GEV No.</b>	511950	<b>Ref. No.</b>	35273
<b>description</b>	reducer thread 3/8" ET - 1/4" IT stainless steel		

## fittings

### double nipples

			
1			
<b>GEV No.</b>	506277	<b>Ref. No.</b>	332162
<b>description</b>	double nipple SS thread 3/8" - 3/4" Qty 1 pcs		

			
1			
<b>GEV No.</b>	510464	<b>Ref. No.</b>	33477
<b>description</b>	angle piece thread 1/4" IT - 3/8" IT brass		
<b>For models:</b>	C81, C81E, C81EBT, C90, C90DE, C90DE2, C90E, C90E2, C90EBT, C90EBT2, C98, CA120, CA55, CA90, CAP7, CAP7E, ED550, ED650E, ED650S, EDI13, EDI13-2, EDI13ALTA, EDI13ALTA-2, EDI13ALTABT, EDI13BT, EDI6, EDI6-2, EDI6BT, EDI8, EDI8-2, EDI8BT, HD130BT, HD60BT, HD80BT, LO134, LO134-2, LO134ALTA, LO134ALTA-2, LO50E, LO62, LO67, LO67-2, LO83, LO83-2, RCA1100, RCA1200, RCA1200i, RLO200, RLO300...(Other models you can see in the webshop)		

			
1			
<b>GEV No.</b>	506272	<b>Ref. No.</b>	190696
<b>description</b>	double nipple plastic thread 3/8" - 3/4" Qty 1 pcs		
<b>For models:</b>	HT100, HT150, HTP195, HTP205, HTP220		

			
1			
<b>GEV No.</b>	520821	<b>Ref. No.</b>	37667
<b>description</b>	angle piece thread 1/4" IT - 1/4" IT nickel-plated brass		
<b>For models:</b>	CAP7E		





Зип Общежит

nickel-plated brass

vsezip.ru

+7(812)987-08-81

			
1			
<b>GEV No.</b>	511951	<b>Ref. No.</b>	35272
<b>description</b>	angle piece thread 3/8" IT - 3/8" IT stainless steel		

			
1			
<b>GEV No.</b>	520201	<b>Ref. No.</b>	34426
<b>description</b>	hose connector nickel-plated brass straight thread 1/4" hose ø 12mm Qty 1 pcs		
<b>For models:</b>	C81, C81E, C81EBT, C90, C90DE, C90DE2, C90E, C90E2, C90EBT, C90EBT2, C98, CAP7E, EDI13, EDI13-2, EDI13ALTA, EDI13ALTA-2, EDI13ALTABT, EDI13BT, EDI6, EDI6-2, EDI6BT, EDI8, EDI8-2, EDI8BT, HD130BT, HD60BT, HD80BT, LO134, LO134-2, LO134ALTA, LO134ALTA-2, LO50, LO50E, LO62, LO67, LO67-2, LO83, LO83-2, RLO200, RLO300, RLO400, RLO50, SMW15, SMW15E, SP81, SP81E, US-X501		

hose connectors

plastic

			
1			
<b>GEV No.</b>	361997	<b>Ref. No.</b>	180331
<b>description</b>	hose connector plastic angled thread 3/8" hose ø 12mm Qty 1 pcs		
<b>For models:</b>	HT100, HT150, HTP195, HTP205, HTP220		

			
1			
<b>GEV No.</b>	361756	<b>Ref. No.</b>	35392
<b>description</b>	hose connector plastic angled thread 3/8" hose ø 6mm Qty 1 pcs		
<b>For models:</b>	60BT, AP43E, AP48E, AP53E, AP60E, C35E, C43-2, C43DE, C43E, C46DE, C46E, C48-2, C48D-2, C48E, C53DE, C53E, C6, C60DE, C60E, C68DE, C68E, C6D, C6DE, C6E, C81E, C90, C90DE, C90E, C90E2, C98, CAP10, CAP10DE, CAP12, CAP12DE, CAP7, CAP7E, CDN3, CDN4, DP35-2, DP35D-2, DP40-2, DP40D-2, DP40D-rib2, DP40-rib2, DP45DE, DP45E, DP50DE, DP50E, EDI13, EDI13-2...(Other models you can see in the webshop)		

brass

			
1			
<b>GEV No.</b>	520877	<b>Ref. No.</b>	34767
<b>description</b>	hose connector brass straight thread M14x1 hose ø 11mm Qty 1 pcs		
<b>For models:</b>	APS43, APS48, APS48B, APS53, APS60, C35, C43, C43D, C48, C48D, C53, C53D, C60, C60D, FW35, FW40, FW40B, FW45, FW50, SP35, SP35D, SP40, SP40D, SP45, SP45D, SP50, SP50-400V, SP50-440V, SP50D, SPB35		

producer-specific

			
1			
<b>GEV No.</b>	510912	<b>Ref. No.</b>	H290217
<b>description</b>	angle piece connection 3/8"-1/2" for pipe ø 12-14mm		
<b>For models:</b>	EDT100, EDT140, EDT170, EDT200, EDT230, EDT85, TR100, TR140, TR170, TR200, TR230, TR90, TR-E100, TR-E150, TR-E170, TR-E200, TR-E230		

			
1			
<b>GEV No.</b>	512021	<b>Ref. No.</b>	H200117+35392+2x33424+H180408+2x25803
<b>description</b>	conversion kit for T-piece		

			
1			
<b>GEV No.</b>	512058	<b>Ref. No.</b>	32352
<b>description</b>	hose connector angled connection 1/4" IT hose ø 10mm		
<b>For models:</b>	APS43, APS48, APS48B, APS53, APS60, APSE43, APSE48, APSE53, APSE60, C3, C35, C4, C43, C43ALTA, C43D, C48, C48D, C48DDL, C48DL, C53, C53D, C60, C60D, DP35, DP35D, DP40, DP40D, DP45, DP45D, DP50, DP50D, FW35, FW40, FW40B, FW45, FW50, GS-X1011, GS-X1011-WEH, GS-X1021, GS-X1021-WEH, RSP50, RSP50A, SP35, SP35ALTA, SP35D, SP40, SP40D, SP40DDL, SP40DL, SP45...(Other models you can see in the webshop)		



Зип Общепит

vsezip.ru

+7(812)987-08-81

			
1			
<b>GEV No.</b>	512245	<b>Ref. No.</b>	33544
<b>description</b>	hose connector thread 1/2" grommet ø 30mm ID ø 16mm grommet length 28mm total length 35mm ED ø 31.5mm		
<b>For models:</b>	60BT, 60BT-3, C43, C43ALTA, C48, C48D, C48DDL, C48DL, C53, C53D, C60, C60D, DP35, DP35D, DP40, DP40D, DP45, DP45D, DP50, DP50D, DP50D-115V, GS-X1011, GS-X1011-WEH, GS-X1021, GS-X1021-WEH, RSP50, RSP50A, SD5BT, SP35, SP35ALTA, SP40, SP40D, SP40DDL, SP40DL, SP45, SP45D, SP50, SP50-400V, SP50-440V, SP50D, STS43, STS43D, STS48, STS48D, STS53, STS53D, STS60, STS60D, TN-TDN5, TN-TDN6...(Other models you can see in the webshop)		



			
1			
<b>GEV No.</b>	512309	<b>Ref. No.</b>	31244
<b>description</b>	T-piece connectionmm plastic		
<b>For models:</b>	TS43		

			
2			
<b>GEV No.</b>	512025	<b>Ref. No.</b>	190315 33474
<b>description</b>	hose connector thread M16x1.25 for hose ID 11mm		
<b>For models:</b>	C98, CA120, CA55, CA90, CAP7, CAP7E, ED550, ED650E, ED650S, LO62, RCA1100, RCA1200, RCA1200i, SO55, SO55-400V3-50Hz-MARINE, SO55-440V3-60Hz-MARINE, SO55E		

			
1			
<b>GEV No.</b>	510984	<b>Ref. No.</b>	H190311
<b>description</b>	T-piece plastic		

			
1			
<b>GEV No.</b>	511274	<b>Ref. No.</b>	180415 H180415
<b>description</b>	manifold 4-way hose ø 12-12-12-12mm plastic		
<b>For models:</b>	DP35-2, DP35D-2, DP40-2, DP40D-2, DP40D-rib2, DP40-rib2, GS-X1021-2, GS-X1021-2rib, GS-X1021-WEH-2, GS-X1021-WEH-2rib, STS43-2, STS43D-2, STS48-2, STS48D-2, STS48D-rib2, STS48-rib2, TDN4-2rib		

			
1			
<b>GEV No.</b>	512311	<b>Ref. No.</b>	30435
<b>description</b>	T-piece plastic		
<b>For models:</b>	E40-2F, INDY53F, UNI53C, UNI60C		

			
1			
<b>GEV No.</b>	512093	<b>Ref. No.</b>	33817
<b>description</b>	T-piece connection 1: 12mm connection 2: 4mm		
<b>For models:</b>	C35, C43, C43ALTA, C43D, C48, C48D, C48DDL, C48DL, C53, C53D, C60, C60D, C81, C90, CA120, CA55, CA90, CR43, CR43D, CR48, CR48D, DP35, DP35D, DP40, DP40D, DP45, DP45D, DP50, DP50D, DP50D-115V, ED550, ED650E, ED650S, GS-X1011, GS-X1011-WEH, GS-X1021, GS-X1021-WEH, LO50, RCA1100, RCA1200, RCA1200i, RLO50, SP35, SP35ALTA, SP35D, SP40, SP40D, SP40DDL, SP40DL, SP45...(Other models you can see in the webshop)		
<b>accessories for</b>	512093		
	<b>GEV No.</b>	361083	<b>Ref. No.</b> —
union nut T1: M10x1 for hose 6mm			

			
1			
<b>GEV No.</b>	512310	<b>Ref. No.</b>	30434
<b>description</b>	T-piece plastic for dishwashers		
<b>For models:</b>	INDY43F, INDY48F, TS48, UNI43C, UNI48C, UNI48CD		

			
1			
<b>GEV No.</b>	511277	<b>Ref. No.</b>	33502
<b>description</b>	T-piece thread 1/2" ø 18mm		
<b>For models:</b>	C43-2, C43DE, C43E, C46DE, C46E, C48-2, C48D-2, C53DE, C6, C60DE, C68DE, C68E, C6D, C6DE, CA120, CA55, CA90, CAP10, CAP12, CAP7, DP35-2, DP35D-2, DP40-2, DP40D-2, DP40D-rib2, DP40-rib2, ED550, ED650E, ED650S, GS-X1011, GS-X1011-2, GS-X1011-WEH, GS-X1011-WEH-2, GS-X1021, GS-X1021-2, GS-X1021-2rib, GS-X1021-WEH, GS-X1021-WEH-2, GS-X1021-WEH-2rib, RCA1100, RCA1200, RCA1200i, SO100, SO100-400V3-50Hz-MARINE, SO100-440V3-60Hz-MARINE, SO120, SO55, SO55-400V3-50Hz-MARINE, SO55-440V3-60Hz-MARINE, SP35-2...(Other models you can see in the webshop)		





water cycle components

supply filters

			
1			
<b>GEV No.</b>	510836	<b>Ref. No.</b>	620209 H620209
<b>description</b>	supply filter thread 3/4" ET - 3/4" IT total length 76mm plastic		
<b>For models:</b>	CAP15EBT		

ancillary products

clamps

hose clamps

DIN 3017 - W2

			
1			
<b>GEV No.</b>	520111	<b>Ref. No.</b>	33424
<b>description</b>	hose clamp ø 10-16mm width 9mm Qty 10 pcs DIN 3017		
<b>For models:</b>	60BT, AP43E, AP48E, AP53E, AP60E, C35, C35E, C43-2, C43DE, C43E, C46DE, C46E, C48-2, C48D-2, C48E, C53DE, C53E, C6, C60DE, C60E, C68DE, C68E, C6D, C6DE, C6E, C81E, C90, C90DE, C90DE2, C90E, C90E2, C98, CAP10, CAP10DE, CAP12, CAP12DE, CAP7, CAP7E, CDN3, CDN4, DP35-2, DP35D-2, DP40-2, DP40D-2, DP40D-rib2, DP40-rib2, DP45DE, DP45E, DP50DE, DP50E...(Other models you can see in the webshop)		

			
1			
<b>GEV No.</b>	520113	<b>Ref. No.</b>	25807
<b>description</b>	hose clamp ø 16-27mm width 9mm Qty 10 pcs DIN 3017		
<b>For models:</b>	60BT, 60BT-3, 60EBT, AP43E, AP48E, AP53E, AP60E, APS43, APS48, APS48B, APS53, APS60, APSE43, APSE48, APSE53, APSE60, BPN48, BPS43, BPS52, C3, C35, C35E, C4, C43, C43-2, C43ALTA, C43D, C43DE, C43E, C46DE, C46E, C48, C48-2, C48D, C48D-2, C48DDL, C48DL, C48E, C53, C53D, C53DE, C53E, C6, C60, C60D, C60DE, C60E, C68DE, C68E, C68EBT...(Other models you can see in the webshop)		

Зип Общепит

vsezip.ru

+7(812)987-08-81

			
1			
<b>GEV No.</b>	520117	<b>Ref. No.</b>	25809 450135 H450135
<b>description</b>	hose clamp stainless steel ø 40-60mm width 9mm Qty 5 pcs DIN 3017		
<b>For models:</b>	60BT, 60BT-3, 60EBT, AC101, AC151, AC181, AC201, AC241, AC91, AP43E, AP48E, AP53E, AP60E, APS43, APS48, APS48B, APS53, APS60, APSE43, APSE48, APSE53, APSE60, BPN48, BPS43, BPS52, C35E, C43-2, C43DE, C43E, C46DE, C46E, C48-2, C48D-2, C48E, C53, C53D, C53DE, C53E, C6, C60, C60D, C60DE, C60E, C68DE, C68E, C68EBT, C6D, C6DE, C6E, C6EBT...(Other models you can see in the webshop)		

DIN 3017 - W4

			
1			
<b>GEV No.</b>	520120	<b>Ref. No.</b>	25803
<b>description</b>	hose clamp SS W4 ø 12-20mm width 9mm Qty 1 pcs DIN 3017		
<b>For models:</b>	60BT, 60BT-3, 60EBT, AP43E, AP48E, AP53E, AP60E, APS43, APS48, APS48B, APS53, APS60, APSE43, APSE48, APSE53, APSE60, BPN48, BPS43, BPS52, C3, C35, C35E, C4, C43, C43-2, C43ALTA, C43D, C43DE, C43E, C46DE, C46E, C48, C48-2, C48D, C48D-2, C48DDL, C48DL, C48E, C53, C53D, C53DE, C53E, C6, C60, C60D, C60DE, C60E, C68DE, C68E, C68EBT...(Other models you can see in the webshop)		

measuring equipment

thermometers

built-in thermometers

			
1			
<b>GEV No.</b>	541095	<b>Ref. No.</b>	26236
<b>description</b>	thermometer mounting measurements 58x25.5mm 0 up to +120°C capillary pipe 3000mm probe ø 6.5mm probe L 20mm		
<b>For models:</b>	C81, C90, C98, CA120, CA55, CA90, CAP7, CM43, CM48, CM52, CM60, CMD43, CMD48, CMD52, CMD60, ED550, ED600-95, ED630-90, ED650E, ED650E-90, ED650S, ED650S-90, ED700, ED700-90, ED900, ED900-90, EDI13, EDI13ALTA, EDI5, EDI6, EDI8, INDY43F, INDY48F, INDY53F, INDY60F, K80F, K80G, LO122, LO134, LO134ALTA, LO50, LO60, LO61, LO62, LO67, LO78, LO83, M60, NK43, NK48...(Other models you can see in the webshop)		

water and beverage technology

ø52mm



<b>GEV No.</b>	541065	<b>Ref. No.</b>	450905 H450905
<b>description</b>	thermometer mounting ø 52mm t.max. 120°C 0 up to +120°C probe ø 6.5mm probe L 28mm capillary pipe 1500mm		

Зип Общепит

vsezip.ru

+7(812)987-08-81

<b>GEV No.</b>	560231	<b>Ref. No.</b>	33277
<b>description</b>	sheet metal screws ø 2.9mm L 9.5mm SS Qty 20 pcs DIN 7982/ISO 7050 head ø 5.5mm sunk head		
<b>For models:</b>	60BT, 60BT-3, 60EBT, APS43, APS48, APS48B, APS53, APS60, APSE43, APSE48, APSE53, APSE60, C35, C35E, C43, C43-2, C43ALTA, C43D, C43DE, C43E, C46DE, C46E, C48, C48-2, C48D, C48D-2, C48DDL, C48DL, C48E, C53, C53D, C53DE, C53E, C6, C60, C60D, C60DE, C60E, C68DE, C68E, C68EBT, C6D, C6DE, C6E, C81, C81E, C81EBT, C90, C90DE, C90DE2...(Other models you can see in the webshop)		

## fastening material

### screws

#### sheet metal screws



<b>GEV No.</b>	560095	<b>Ref. No.</b>	25684
<b>description</b>	sheet metal screws ø 2.9mm L 9.5mm SS Qty 20 pcs DIN 7981/ISO 7049 head ø 5.6mm oval head		
<b>For models:</b>	60BT, 60BT-3, AP43E, AP48E, APS43, APS48, APS48B, APS53, APS60, APSE43, APSE48, APSE53, APSE60, BPN48, BPS43, BPS52, C3, C4, C53, C53D, C6, C60, C60D, C6D, DP35, DP35D, DP40, DP40D, DP45, DP45D, DP50, DP50D, DP50D-115V, E40, E40-2F, E43, E50, ED900-90, FW35, FW35E, FW40, FW40B, FW40E, FW45, FW50, LO122, RSP50, RSP50A, SD5BT, SP45...(Other models you can see in the webshop)		

<b>GEV No.</b>	560459	<b>Ref. No.</b>	260706 34815
<b>description</b>	screw ø 3.3mm L 13mm SS Qty 1 pcs intake Phillips head ø 4mm		
<b>For models:</b>	60EBT, AP53E, AP60E, C35E, C43-2, C43ALTA, C43DE, C43E, C46DE, C46E, C48-2, C48D-2, C48DDL, C48DL, C48E, C53DE, C53E, C6, C60DE, C60E, C68DE, C68E, C68EBT, C6D, C6DE, C6E, C6EBT, CDN3, CDN4, DP35-2, DP35D-2, DP40-2, DP40D-2, DP40D-rib2, DP40-rib2, DP45DE, DP45E, DP50D-115V, DP50DE, DP50E, DP50EBT, GS-X1011-2, GS-X1011-WEH-2, GS-X1021-2, GS-X1021-2rib, GS-X1021-WEH-2, GS-X1021-WEH-2rib, RSP40, RSP40A, RSP50...(Other models you can see in the webshop)		

<b>GEV No.</b>	560100	<b>Ref. No.</b>	25714
<b>description</b>	sheet metal screws ø 3.5mm L 19mm SS Qty 20 pcs DIN 7981/ISO 7049 head ø 6.9mm oval head		
<b>For models:</b>	APS43, APS48, APS48B, APS53, APS60, APSE43, APSE48, APSE53, APSE60, C3, C4, C53, C53D, C60, C60D, CM43, CM48, CM52, CM60, CMD43, CMD48, CMD52, CMD60, DP35, DP35D, DP40, DP40D, DP45, DP45D, DP50, DP50D, E36, E40, E43, E50, ED600-95, ED630-90, ED650E-90, ED650S-90, ED700, ED700-90, ED900, ED900-90, EDI5, FW35, FW40, FW40B, FW45, FW50, INDY43F...(Other models you can see in the webshop)		

<b>GEV No.</b>	517795	<b>Ref. No.</b>	34503
<b>description</b>	screw ø 3.9mm L 9mm SS Qty 1 pcs for rinse arm		
<b>For models:</b>	APS43, APS48, APS48B, APS53, APS60, FW35, FW40, FW40B, FW45, FW50		

#### countersunk screws

<b>GEV No.</b>	560450	<b>Ref. No.</b>	26691
<b>description</b>	countersunk screw thread M4 L 8mm SS DIN 965/ISO 7046 Qty 1 pcs intake Phillips head ø 7.3mm		
<b>For models:</b>	60BT, 60BT-3, 60EBT, APS43, APS48, APS48B, APS53, APS60, C35, C35E, C43, C43-2, C43ALTA, C43D, C43DE, C43E, C46DE, C46E, C48, C48-2, C48D, C48D-2, C48DDL, C48DL, C48E, C53, C53D, C53DE, C53E, C60, C60D, C60DE, C60E, C68DE, C68E, C68EBT, C6DE, C6E, C81, C81E, C81EBT, C90, C90DE, C90DE2, C90E, C90E2, C90EBT, C90EBT2, CDN3, CDN4...(Other models you can see in the webshop)		



Зип Общепит

vsezip.ru

77(812)987-08-81

flat-headed bolts



<b>GEV No.</b>	560062	<b>Ref. No.</b>	23699
<b>description</b>	flat-headed bolt thread M4 thread L 10mm SS DIN 7985/ISO 7045 Qty 20 pcs intake Phillips head ø 8mm head thickness 2mm		
<b>For models:</b>	60EBT, AP53E, AP60E, APS43, APS48, APS48B, APS53, APS60, APSE43, APSE48, APSE53, APSE60, C3, C35, C4, C43, C43ALTA, C43D, C48, C48D, C48DDL, C48DL, C53, C53D, C53DE, C53E, C60, C60D, C60DE, C60E, C68DE, C68E, C6DE, C6E, C81, C81E, C81EBT, C90, C90DE, C90DE2, C90E, C90E2, C90EBT, C90EBT2, C98, CA120, CA55, CA90, CAP10, CAP10BT...(Other models you can see in the webshop)		



<b>GEV No.</b>	560088	<b>Ref. No.</b>	25716 260105
<b>description</b>	hexagonal screw thread M6 thread L 20mm SS WS 10 Qty 20 pcs DIN 933 / ISO 4017		
<b>For models:</b>	60EBT, AP43E, AP48E, AP53E, AP60E, C35E, C43, C43-2, C43ALTA, C43D, C43DE, C43E, C46DE, C46E, C48, C48-2, C48D, C48D-2, C48DDL, C48DL, C48E, C53, C53D, C53DE, C53E, C6, C60, C60D, C60DE, C60E, C68DE, C68E, C68EBT, C6D, C6DE, C6E, C6EBT, C90EBT, CR43, CR43D, CR48, CR48D, DP35-2, DP35D-2, DP40-2, DP40D-2, DP40D-rib2, DP40-rib2, DP45DE, DP45E...(Other models you can see in the webshop)		



<b>GEV No.</b>	511004	<b>Ref. No.</b>	H260226
<b>description</b>	flat-headed bolt thread M4 thread L 12mm SS DIN 84/ISO 1207 Qty 1 pcs intake slotted L 14.5mm		
<b>For models:</b>	C68DE, C68E, CA120, CA55, CA90, ED550, ED650E, ED650S, EDT100, EDT140, EDT85, RCA1100, RCA1200, RCA1200i, SP68DE, SP68E, TR100, TR140, TR90, TR-E100, TR-E150, TR-E170, TR-E200, TR-E230		



<b>GEV No.</b>	560089	<b>Ref. No.</b>	25719
<b>description</b>	hexagonal screw thread M6 thread L 25mm SS WS 10 Qty 20 pcs DIN 933 / ISO 4017		
<b>For models:</b>	APS43, APS48, APS53, APS60, APSE43, APSE48, APSE53, APSE60, C90DE2, C90E2, C90EBT2, CDN3, CDN4, ED630-90, EDI13, EDI13ALTA, EDI6, EDI8, LO134, LO134ALTA, LO67, LO83, RLO200, RLO300, RLO400		



<b>GEV No.</b>	560529	<b>Ref. No.</b>	H260207
<b>description</b>	flat-headed bolt thread M4 thread L 25mm SS DIN 84/ISO 1207 Qty 1 pcs intake slotted head ø 7mm head thickness 2.5mm		
<b>For models:</b>	CA120, CA55, CA90, ED550, ED650E, ED650S, RCA1100, RCA1200, RCA1200i		



<b>GEV No.</b>	503122	<b>Ref. No.</b>	25728
<b>description</b>	hexagonal screw thread M8 thread L 10mm SS WS 13 Qty 1 pcs DIN 933 / ISO 4017		
<b>For models:</b>	AP53E, AP60E, BPN48, BPS43, BPS52, C81EBT, C90EBT2, DP45DE, DP45E, DP50DE, DP50E, E36, E40, E40-2F, ED700, ED900, EDI13-2, EDI13ALTA-2, EDI4, EDI6-2, EDI8-2, HD40ALTABT, HD40BT, HD60BT, HD80BT, INDY43F, INDY48F, INDY53F, INDY60F, LO134-2, LO134ALTA-2, LO56, LO67-2, LO83-2, ST53DE, ST53E, ST60DE, ST60E, TS43, TS48, UNI43C, UNI48C, UNI48CD, UNI53C, UNI60C		

hexagonal screws



<b>GEV No.</b>	560083	<b>Ref. No.</b>	25708
<b>description</b>	hexagonal screw thread M5 thread L 10mm SS WS 8 Qty 20 pcs DIN 933 / ISO 4017		
<b>For models:</b>	60BT, 60BT-3, APS43, APS48, APS48B, APS53, APS60, APSE43, APSE48, APSE53, APSE60, C3, C35, C35E, C4, C43, C43-2, C43ALTA, C43D, C48, C48-2, C48D, C48D-2, C48DDL, C48DL, C48E, C53, C53D, C6, C60, C60D, C68DE, C68E, C68EBT, C6D, C81, C81E, C81EBT, C90, C90DE, C90DE2, C90E, C90E2, C90EBT, C90EBT2, C98, CDN3, CDN4, CR43, CR43D...(Other models you can see in the webshop)		



<b>GEV No.</b>	560464	<b>Ref. No.</b>	25729
<b>description</b>	hexagonal screw thread M8 thread L 12mm SS WS 13 Qty 1 pcs head thickness 5mm DIN 933 / ISO 4017		
<b>For models:</b>	ED650S, ED650S-90, EDI13, EDI13ALTA, EDI6, EDI8, LO134, LO134ALTA, LO67, LO83, RLO200, RLO300, RLO400		



<b>GEV No.</b>	560084	<b>Ref. No.</b>	25705 H260126
<b>description</b>	hexagonal screw thread M5 thread L 16mm SS WS 8 Qty 20 pcs DIN 933 / ISO 4017		
<b>For models:</b>	60BT, 60BT-3, 60EBT, C53DE, C53E, C60, C60D, C60DE, C60E, C68DE, C68E, C68EBT, C81, C81E, C90, C90DE, C90DE2, C90E, C90E2, CA55, CAP10DE, CAP12DE, CAP7, CAP7E, CDN3, CDN4, CR43, CR43D, CR48, CR48D, DP50, DP50D, DP50DE, DP50E, DP50EBT, ED550, ED630-90, ED700-90, EDI13-2, EDI13ALTA-2, EDI13ALTABT, EDI13BT, EDI4, EDI6-2, EDI6BT, EDI8-2, EDI8BT, EDT100, EDT140, EDT170...(Other models you can see in the webshop)		

Зип-Общепит

## cylinder head bolts

DIN 912/ISO 4762



1

<b>GEV No.</b>	560025	<b>Ref. No.</b>	25700
<b>description</b>	cylinder head bolt thread M4 thread L 10mm WS 3 SS Qty 20 pcs DIN 912/ISO 4762		
<b>For models:</b>	60BT, 60BT-3, AP43E, AP48E, AP53E, AP60E, APS43, APS48, APS48B, APS53, APS60, APSE43, APSE48, APSE53, APSE60, BPN48, BPS43, BPS52, C3, C35, C35E, C4, C43, C43-2, C43ALTA, C43D, C43DE, C43E, C46DE, C46E, C48, C48-2, C48D, C48D-2, C48DDL, C48DL, C48E, C53, C53D, C53E, C6, C60, C60D, C60E, C68DE, C68E, C6D, C6E, C81, C81E... (Other models you can see in the webshop)		



2

<b>GEV No.</b>	560402	<b>Ref. No.</b>	25990
<b>description</b>	cylinder head bolt thread M5 thread L 10mm L 15.5mm WS 4 SS Qty 1 pcs intake hexagonal DIN 912/ISO 4762		
<b>For models:</b>	APS43, APS48, APS53, APS60, APSE43, APSE48, APSE53, APSE60, C35, C43, C43ALTA, C43D, C48, C48D, C48DDL, C48DL, C53, C53D, C60, C60D, CDN3, CDN4, CR43, CR43D, CR48, CR48D, DP35, DP35D, DP40, DP40D, DP45, DP45D, DP50, DP50D, FW35, FW40, FW45, FW50, SP35, SP35ALTA, SP35D, SP40, SP40D, SP40DDL, SP40DL, SP45, SP45D, SP50, SP50-400V, SP50-440V... (Other models you can see in the webshop)		

## knurled screws



1

<b>GEV No.</b>	510307	<b>Ref. No.</b>	261009 H261009
<b>description</b>	Thumb screw thread M6 H 3mm thread L 8mm ø 28mm SS		
<b>For models:</b>	C35, C35E, C43, C43-2, C43ALTA, C43D, C43DE, C43E, C46DE, C46E, C48, C48-2, C48D, C48D-2, C48DDL, C48DL, C48E, C6, C68DE, C68E, C68EBT, C6D, C6DE, C6E, C6EBT, C90DE2, C90E2, C90EBT2, C98, CA120, CA55, CA90, CAP10, CAP10BT, CAP10DE, CAP12, CAP12DE, CAP12EBT, CAP15EBT, CAP7, CAP7E, ED550, ED650E, ED650S, EDI13-2, EDI13ALTA-2, EDI13ALTABT, EDI13BT, EDI4, EDI6-2... (Other models you can see in the webshop)		

## nuts

## cap nuts



1

<b>GEV No.</b>	560136	<b>Ref. No.</b>	26761
<b>description</b>	cap nuts thread M5 WS 8 SS Qty 20 pcs DIN/ISO DIN 1587		
<b>For models:</b>	AP43E, AP48E, AP53E, AP60E, APS43, APS48, APS53, APS60, APSE43, APSE48, APSE53, APSE60, BPN48, C3, C4, CM43, CM48, CM52, CM60, CMD43, CMD48, CMD52, CMD60, DP35, DP35D, DP40, DP40D, DP45, DP45D, DP45DE, DP45E, DP50, DP50D, DP50DE, DP50E, DP50EBT, E36, E40, E40-2F, E43, E50, ED600-95, ED700-90, ED900-90, EDI5, FW35, FW35E, FW40, FW40E, FW45... (Other models you can see in the webshop)		

knurled nuts

vsezip.ru

1

<b>GEV No.</b>	512257	<b>Ref. No.</b>	34382
<b>description</b>	knurled nut thread M10L ø 30mm H 6.5mm SS		
<b>For models:</b>	60BT, 60BT-3, C35, C43, C43D, C48, C48D, C53, C53D, C60, C60D, C81, C90, DP35, DP35D, DP40, DP40D, DP45, DP45D, DP50, DP50D, DP50D-115V, GS-X1021, GS-X1021-WEH, LO50, RSP50, RSP50A, SD5BT, SP35, SP35D, SP40, SP40D, SP45, SP45D, SP50, SP50-400V, SP50-440V, SP50D, SP81, SPB35, STS43, STS43D, STS48, STS48D, STS53, STS53D, STS60, STS60D, TN-TDN5, TN-TDN6... (Other models you can see in the webshop)		



1

<b>GEV No.</b>	512212	<b>Ref. No.</b>	34998
<b>description</b>	knurled nut thread M10x1.5 ø 30mm H 6.4mm SS		
<b>For models:</b>	60EBT, C53DE, C53E, C60DE, C60E, C81, C81E, C81EBT, C90, C90DE, C90E, C90EBT, DP35-2, DP35D-2, DP40-2, DP40D-2, DP40D-rib2, DP40-rib2, DP45DE, DP45E, DP50DE, DP50E, DP50EBT, EDI13, EDI13ALTA, EDI6, EDI8, GS-X1021-2, GS-X1021-2rib, GS-X1021-WEH-2, GS-X1021-WEH-2rib, LO134, LO134ALTA, LO50, LO50E, LO67, LO83, RLO200, RLO300, RLO400, RLO50, SMW15, SMW15E, SP45DE, SP45E, SP50DE, SP50E, SP50E-400V3-50Hz-MARINE, SP50E-440V3-60Hz-MARINE, SP81... (Other models you can see in the webshop)		



1

<b>GEV No.</b>	510346	<b>Ref. No.</b>	H280409
<b>description</b>	knurled nut thread M17x1 ø 35mm H 6mm SS		

## hexagonal nuts

DIN 934 / ISO 4032/8673



1

<b>GEV No.</b>	560340	<b>Ref. No.</b>	25773
<b>description</b>	hexagonal nut thread M4 H 3.2mm WS 7 SS DIN/ISO DIN 934 / ISO 4032/8673 Qty 1 pcs		
<b>For models:</b>	60BT, 60BT-3, 60EBT, AP43E, AP48E, AP53E, AP60E, APS43, APS48, APS48B, APS53, APS60, APSE43, APSE48, APSE53, APSE60, BPN48, BPS43, BPS52, C3, C35, C35E, C4, C43, C43-2, C43ALTA, C43D, C43DE, C43E, C46DE, C46E, C48, C48-2, C48D, C48D-2, C48DDL, C48DL, C48E, C53, C53D, C53DE, C53E, C6, C60, C60D, C60DE, C60E, C68DE, C68E, C68EBT... (Other models you can see in the webshop)		





Зип Общепит

vsezip.ru

7(812)987-08-81

			
1			
<b>GEV No.</b>	560131	<b>Ref. No.</b>	25773
<b>description</b>	hexagonal nut thread M4 H 3.2mm WS 7 SS DIN/ISO DIN 934 / ISO 4032/8673 Qty 20 pcs		

			
1			
<b>GEV No.</b>	560129	<b>Ref. No.</b>	25774
<b>description</b>	hexagonal nut thread M5 H 4mm WS 8 SS DIN/ISO DIN 934 / ISO 4032/8673 Qty 1 pcs		
<b>For models:</b>	60BT, 60BT-3, 60EBT, AP43E, AP48E, AP53E, AP60E, APS43, APS48, APS48B, APS53, APS60, APSE43, APSE48, APSE53, APSE60, BPN48, BPS43, BPS52, C3, C35, C35E, C4, C43, C43-2, C43ALTA, C43D, C43DE, C43E, C46DE, C46E, C48, C48-2, C48D, C48D-2, C48DDL, C48DL, C48E, C53, C53D, C53DE, C53E, C6, C60, C60D, C60DE, C60E, C68DE, C68E, C68EBT...(Other models you can see in the webshop)		

			
1			
<b>GEV No.</b>	511212	<b>Ref. No.</b>	25775
<b>description</b>	hexagonal nut thread M6 H 5mm WS 10 SS DIN/ISO DIN 934 / ISO 4032/8673 Qty 1 pcs		
<b>For models:</b>	60BT, 60BT-3, 60EBT, AP43E, AP48E, AP53E, AP60E, APS43, APS48, APS48B, APS53, APS60, APSE43, APSE48, APSE53, APSE60, BPN48, BPS43, BPS52, C3, C35, C35E, C4, C43, C43-2, C43ALTA, C43D, C43DE, C43E, C46DE, C46E, C48, C48-2, C48D, C48D-2, C48DDL, C48DL, C48E, C53, C53D, C53DE, C53E, C6, C60, C60D, C60DE, C60E, C68DE, C68E, C68EBT...(Other models you can see in the webshop)		

			
1			
<b>GEV No.</b>	560197	<b>Ref. No.</b>	26758
<b>description</b>	nut thread M10 H 8mm WS 17 SS DIN/ISO DIN 934 / ISO 4032/8673 Qty 1 pcs		
<b>For models:</b>	ED550, ED600-95, ED700-90, ED900-90, EDI5, LO122, LO60, LO61, LO78		

DIN 985			
			
1			
<b>GEV No.</b>	560140	<b>Ref. No.</b>	30194
<b>description</b>	hexagonal nut thread M4 H 4.8mm WS 7 Qty 20 pcs DIN/ISO DIN 985 self-locking		
<b>For models:</b>	60EBT, AP43E, AP48E, AP53E, AP60E, C43DE, C43E, C46DE, C46E, C53DE, C53E, C60DE, C60E, C68DE, C68E, C68EBT, C6DE, C6E, C6EBT, C98, DP45DE, DP45E, DP50DE, DP50E, DP50EBT, EDI13, EDI13-2, EDI13ALTA, EDI13ALTA-2, EDI6, EDI6-2, EDI8, EDI8-2, FW35E, FW40E, LO134, LO134-2, LO134ALTA, LO134ALTA-2, LO62, LO67, LO67-2, LO83, LO83-2, SP35DE, SP35E, SP40DE, SP40E, SP45DE, SP45E...(Other models you can see in the webshop)		

			
1			
<b>GEV No.</b>	560142	<b>Ref. No.</b>	25792
<b>description</b>	hexagonal nut thread M6 H 6mm SS WS 10 Qty 20 pcs DIN/ISO DIN 985 self-locking		

hexagonal nuts metric (without norm)			
			
1			
<b>GEV No.</b>	512313	<b>Ref. No.</b>	30436
<b>description</b>	nut		
<b>For models:</b>	E40-2F, INDY43F, INDY48F, INDY53F, INDY60F, TS43, TS48, UNI43C, UNI48C, UNI48CD, UNI53C, UNI60C		

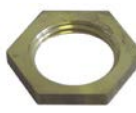
hexagonal nuts inch thread			
			
1			
<b>GEV No.</b>	511200	<b>Ref. No.</b>	15242
<b>description</b>	nut thread 1" H 6mm brass WS 45 Qty 1 pcs		
<b>For models:</b>	CDN3, CDN4, CM52, CM60, CMD52, CMD60, CR43, CR43D, CR48, CR48D, K80F, K80G, M60, NK52, NK60, NKD52, NKD60, SPR36, SPR36D, SPR41, SPR41D, T5-80, T6-80, UNI43R, UNI43RD, UNI48R, UNI48RD, UNI53R, UNI53RD		

			
1			
<b>GEV No.</b>	511309	<b>Ref. No.</b>	H270104
<b>description</b>	nut thread 1 1/2" ø 66mm H 9mm WS 51 brass Qty 1 pcs		
<b>For models:</b>	EDI13-2, EDI13ALTA-2, EDI13ALTABT, EDI13BT, EDI6-2, EDI6BT, EDI8-2, EDI8BT, EDT100, EDT140, EDT170, EDT200, EDT230, EDT85, LO134-2, LO134ALTA-2, LO67-2, LO83-2, TR100, TR140, TR170, TR200, TR230, TR90, TR-E100, TR-E150, TR-E170, TR-E200, TR-E230, TR-E90		

## washers

### spring rings

			
1			
<b>GEV No.</b>	560123	<b>Ref. No.</b>	260512
<b>description</b>	lock washer ID ø 6.3mm ED ø 11mm SS DIN127 Qty 20 pcs for thread M6		
<b>For models:</b>	AC151, CAP15EBT, EDT140, HG2LR, HGLR, HTP195, HTP205, HTP220, TR200, TR230		

## washers

## DIN 125A



1

<b>GEV No.</b>	560332	<b>Ref. No.</b>	25743
<b>description</b>	plain washer ID ø 4.3mm ED ø 9mm thickness 0.8mm SS Qty 1 pcs		
<b>For models:</b>	60BT, 60BT-3, 60EBT, AP43E, AP48E, AP53E, AP60E, APS43, APS48, APS48B, APS53, APS60, APSE43, APSE48, APSE53, APSE60, BPN48, BPS43, BPS52, C3, C35, C35E, C4, C43, C43-2, C43ALTA, C43D, C43DE, C43E, C46DE, C46E, C48, C48-2, C48D, C48D-2, C48DDL, C48DL, C48E, C53, C53D, C53DE, C53E, C6, C60, C60D, C60DE, C60E, C68DE, C68E, C68EBT...(Other models you can see in the webshop)		



1

<b>GEV No.</b>	560112	<b>Ref. No.</b>	25744
<b>description</b>	plain washer ID ø 5.3mm ED ø 10mm thickness 1mm SS Qty 20 pcs DIN 125A for thread M5		
<b>For models:</b>	60BT, 60BT-3, 60EBT, AP43E, AP48E, AP53E, AP60E, APS43, APS48, APS48B, APS53, APS60, APSE43, APSE48, APSE53, APSE60, BPN48, BPS43, BPS52, C3, C35, C35E, C4, C43, C43-2, C43ALTA, C43D, C43DE, C43E, C46DE, C46E, C48, C48-2, C48D, C48D-2, C48DDL, C48DL, C48E, C53, C53D, C53DE, C53E, C6, C60, C60D, C60DE, C60E, C68DE, C68E, C68EBT...(Other models you can see in the webshop)		



1

<b>GEV No.</b>	560333	<b>Ref. No.</b>	25745
<b>description</b>	plain washer ID ø 6.4mm ED ø 12mm thickness 1.6mm SS Qty 1 pcs DIN 125A for thread M6		
<b>For models:</b>	AP43E, AP48E, AP53E, AP60E, APS43, APS48, APS48B, APS53, APS60, APSE43, APSE48, APSE53, APSE60, BPN48, BPS43, BPS52, C3, C35, C4, C43, C43-2, C43ALTA, C43D, C48, C48-2, C48D, C48D-2, C48DDL, C48DL, C48E, C53, C53D, C6, C60, C60D, C6D, C81, C81E, C81EBT, C90, C90DE, C90DE2, C90E, C90E2, C90EBT, C90EBT2, C98, CA120, CA55, CA90...(Other models you can see in the webshop)		

## DIN 9021



1

<b>GEV No.</b>	560117	<b>Ref. No.</b>	25746 260538
<b>description</b>	plain washer ID ø 6.4mm ED ø 18mm thickness 1.5mm SS Qty 20 pcs DIN 9021 for thread M6		
<b>For models:</b>	60EBT, AC101, AC151, AC181, AC201, AC241, AC91, AP43E, AP48E, AP53E, AP60E, BPS43, C35E, C43-2, C43DE, C43E, C46DE, C46E, C48-2, C48D-2, C48E, C6, C68EBT, C6D, C6EBT, C81E, C81EBT, C90DE, C90DE2, C90E, C90E2, C90EBT, C90EBT2, C98, CA120, CA55, CA90, CAP10, CAP10BT, CAP10DE, CAP12, CAP12DE, CAP12EBT, CAP7, CAP7E, CDN3, CDN4, CM48, CM52, CMD43...(Other models you can see in the webshop)		

## tooth lock washers

## DIN 6798A



1

<b>GEV No.</b>	512379	<b>Ref. No.</b>	33836
<b>description</b>	disc		
<b>For models:</b>	AP43E, AP48E, AP53E, AP60E, APS43, APS48, APS48B, APS53, APS60, APSE43, APSE48, APSE53, APSE60, FW35, FW35E, FW40, FW40B, FW40E, FW45, FW50		



1

<b>GEV No.</b>	512060	<b>Ref. No.</b>	33346
<b>description</b>	plain washer ID ø 13mm ED ø 37mm thickness 2.5mm SS Qty 1 pcs for wash arm support		
<b>For models:</b>	60BT, 60BT-3, APS43, APS48, APS48B, APS53, APS60, APSE43, APSE48, APSE53, APSE60, C35, C43, C43ALTA, C43D, C48, C48D, C48DDL, C48DL, C53, C53D, C60, C60D, DP35, DP35D, DP40, DP40D, DP45, DP45D, DP50, DP50D, DP50D-115V, FW35, FW40, FW40B, FW45, FW50, GS-X1011, GS-X1011-WEH, GS-X1021, GS-X1021-WEH, RSP50, RSP50A, SDSBT, SP35, SP35ALTA, SP35D, SP40, SP40D, SP40DDL...(Other models you can see in the webshop)		



1

<b>GEV No.</b>	512041	<b>Ref. No.</b>	25122
<b>description</b>	plain washer ID ø 14mm ED ø 23.5mm thickness 2mm plastic Qty 1 pcs for wash arm		
<b>For models:</b>	C3, C35, C4, C43, C48, C53, C60, DP35, DP35D, DP40, DP40D, DP45, DP45D, DP50, DP50D, ED630-90, ED650E, ED650E-90, ED650S, ED650S-90, ED700, ED900, GS-X1021, GS-X1021-WEH, K80F, STS43, STS43D, STS48, STS48D, STS53, STS53D, STS60, STS60D		

## tooth lock washers

## DIN 6798A



1

<b>GEV No.</b>	560126	<b>Ref. No.</b>	25753
<b>description</b>	tooth lock washer ID ø 5.2mm ED ø 10mm SS DIN/ISO DIN 6798A Qty 20 pcs for thread M5		



1

<b>GEV No.</b>	560127	<b>Ref. No.</b>	25750
<b>description</b>	tooth lock washer ID ø 6.2mm ED ø 11mm SS DIN/ISO DIN 6798A Qty 20 pcs for thread M6		
<b>For models:</b>	60BT, 60BT-3, 60EBT, AP43E, AP48E, AP53E, AP60E, APS43, APS48, APS48B, APS53, APS60, APSE43, APSE48, APSE53, APSE60, BPN48, BPS43, BPS52, C3, C35, C35E, C4, C43, C43-2, C43ALTA, C43D, C43DE, C43E, C46DE, C46E, C48, C48-2, C48D, C48D-2, C48DDL, C48DL, C48E, C53, C53D, C53DE, C53E, C6, C60, C60D, C60DE, C60E, C68DE, C68E, C68EBT...(Other models you can see in the webshop)		



Зип Общепит

vsezip.ru

+7(812)987-08-81

fasteners

clamps

hose clamps

DIN 3017 - W2



1

<b>GEV No.</b>	520111	<b>Ref. No.</b>	33424
<b>description</b>	hose clamp ø 10-16mm width 9mm Qty 10 pcs DIN 3017		
<b>For models:</b>	60BT, AP43E, AP48E, AP53E, AP60E, C35, C35E, C43-2, C43DE, C43E, C46DE, C46E, C48-2, C48D-2, C48E, C53DE, C53E, C6, C60DE, C60E, C68DE, C68E, C6D, C6DE, C6E, C81E, C90, C90DE, C90DE2, C90E, C90E2, C98, CAP10, CAP10DE, CAP12, CAP12DE, CAP7, CAP7E, CDN3, CDN4, DP35-2, DP35D-2, DP40-2, DP40D-2, DP40D-rib2, DP40-rib2, DP45DE, DP45E, DP50DE, DP50E...(Other models you can see in the webshop)		



1

<b>GEV No.</b>	520113	<b>Ref. No.</b>	25807
<b>description</b>	hose clamp ø 16-27mm width 9mm Qty 10 pcs DIN 3017		
<b>For models:</b>	60BT, 60BT-3, 60EBT, AP43E, AP48E, AP53E, AP60E, APS43, APS48, APS48B, APS53, APS60, APSE43, APSE48, APSE53, APSE60, BPN48, BPS43, BPS52, C3, C35, C35E, C4, C43, C43-2, C43ALTA, C43D, C43DE, C43E, C46DE, C46E, C48, C48-2, C48D, C48D-2, C48DDL, C48DL, C48E, C53, C53D, C53DE, C53E, C6, C60, C60D, C60DE, C60E, C68DE, C68E, C68EBT...(Other models you can see in the webshop)		



1

<b>GEV No.</b>	520117	<b>Ref. No.</b>	25809 450135 H450135
<b>description</b>	hose clamp stainless steel ø 40-60mm width 9mm Qty 5 pcs DIN 3017		
<b>For models:</b>	60BT, 60BT-3, 60EBT, AC101, AC151, AC181, AC201, AC241, AC91, AP43E, AP48E, AP53E, AP60E, APS43, APS48, APS48B, APS53, APS60, APSE43, APSE48, APSE53, APSE60, BPN48, BPS43, BPS52, C35E, C43-2, C43DE, C43E, C46DE, C46E, C48-2, C48D-2, C48E, C53, C53D, C53DE, C53E, C6, C60, C60D, C60DE, C60E, C68DE, C68E, C68EBT, C6D, C6DE, C6E, C6EBT...(Other models you can see in the webshop)		



<b>GEV No.</b>	520120	<b>Ref. No.</b>	25803
<b>description</b>	hose clamp SS W4 ø 12-20mm width 9mm Qty 1 pcs DIN 3017		
<b>For models:</b>	60BT, 60BT-3, 60EBT, AP43E, AP48E, AP53E, AP60E, APS43, APS48, APS48B, APS53, APS60, APSE43, APSE48, APSE53, APSE60, BPN48, BPS43, BPS52, C3, C35, C35E, C4, C43, C43-2, C43ALTA, C43D, C43DE, C43E, C46DE, C46E, C48, C48-2, C48D, C48D-2, C48DDL, C48DL, C48E, C53, C53D, C53DE, C53E, C6, C60, C60D, C60DE, C60E, C68DE, C68E, C68EBT...(Other models you can see in the webshop)		

miscellaneous



1

<b>GEV No.</b>	510923	<b>Ref. No.</b>	440817 H440817
<b>description</b>	clamping ring for shaft ø 10mm ID ø 9.4mm H 6mm		
<b>For models:</b>	C98, EDI5, HG2LR, HGLR, LO61, LO62		

retaining rings

DIN 471



1

<b>GEV No.</b>	512260	<b>Ref. No.</b>	32923
<b>description</b>	retaining ring shaft ø 14mm thickness 1.2mm steel DIN 471		
<b>For models:</b>	60BT, 60BT-3, C3, C35, C4, C43, C48, C53, C53D, C60, C60D, DP35, DP35D, DP40, DP40D, DP45, DP45D, DP50, DP50D, DP50D-115V, GS-X1021, GS-X1021-WEH, RSP50, RSP50A, SD5BT, SP45, SP45D, SP50, SP50-400V, SP50-440V, SP50D, STS43, STS43D, STS48, STS48D, STS53, STS53D, STS60, STS60D, TN-TDN5, TN-TDN6, VS-X313, VS-X313-LP-DOS, VS-X515, VS-X515-LP-DOS		



1

<b>GEV No.</b>	514030	<b>Ref. No.</b>	33160
<b>description</b>	retaining ring shaft ø 20mm thickness 1.3mm steel DIN 471		
<b>For models:</b>	APS43, APS48, APS48B, APS53, APS60, APSE43, APSE48, APSE53, APSE60, FW35, FW40, FW40B, FW45, FW50		

Зип Общепит

vsezip.ru

+7(812)987-08-81

## screw caps

			
1			
<b>GEV No.</b>	510233	<b>Ref. No.</b>	290105 H290105
<b>description</b>	screw cap thread 1/2" thread L 12mm brass WS 27 head thickness 7mm		
<b>For models:</b>	AC101, AC151, AC181, AC201, AC241, AC91, EDT100, EDT140, EDT170, EDT200, EDT230, EDT85, HG2LR, HGLR, HTP195, HTP205, HTP220, TR100, TR140, TR170, TR200, TR230, TR90, TR-E100, TR-E150, TR-E170, TR-E200, TR-E230, TR-E90		

			
1			
<b>GEV No.</b>	358032	<b>Ref. No.</b>	28118
<b>description</b>	fine fuse size ø10x38mm 25A rated 500V type Gg fast-acting Qty 1 pcs		
<b>For models:</b>	ED600-95, ED700-90, ED14, ED15, ED16, ED16-2, ED16BT, ED18, ED18-2, ED18BT, LO56, LO60, LO61, LO67, LO67-2, LO78, LO83, LO83-2, RLO200, RLO300		

			
1			
<b>GEV No.</b>	358021	<b>Ref. No.</b>	130260 H130260
<b>description</b>	fine fuse size ø10x38mm 2A rated 500V type gl fast-acting Qty 1 pcs		
<b>For models:</b>	AC101, AC151, AC181, AC201, AC241, AC91, EDT100, EDT140, EDT170, EDT200, EDT230, EDT85, TR100, TR140, TR170, TR200, TR230, TR90, TR-E100, TR-E150, TR-E170, TR-E200, TR-E230		

			
1			
<b>GEV No.</b>	358023	<b>Ref. No.</b>	28048
<b>description</b>	fine fuse size ø10x38mm 6A rated 500V type Gg fast-acting Qty 1 pcs		
<b>For models:</b>	E40, E43, E50, ED600-95, ED630-90, ED700-90, EDI13, EDI13-2, EDI13ALTA, EDI13ALTA-2, EDI13ALTABT, EDI13BT, EDI4, EDI5, EDI6, EDI6-2, EDI6BT, ED18, ED18-2, EDI8BT, LO134, LO134-2, LO134ALTA, LO134ALTA-2, LO56, LO60, LO61, LO67, LO67-2, LO78, LO83, LO83-2, RLO200, RLO300, RLO400		

## consumables

## fuses

## fine fuses

ø10x38mm 500V

			
1			
<b>GEV No.</b>	358028	<b>Ref. No.</b>	130248 H130248
<b>description</b>	fine fuse size ø10x38mm 20A rated 500V type Gg fast-acting Qty 1 pcs		
<b>For models:</b>	AC101, AC151, AC181, AC201, AC241, AC91, EDT100, EDT140, EDT170, EDT200, EDT230, EDT85, HTP195, HTP205, HTP220, TR100, TR140, TR170, TR200, TR230, TR90, TR-E100, TR-E150, TR-E170, TR-E200, TR-E230		



## Зип Общепит

vsezip.ru

+7(812)987-08-81

<b>B</b>		<b>I</b>	
bi-metal thermostats	8, 8	immersion heating elements	3
booster pumps I	45	indicator lights	20
booster pumps II	47	indicator lights (complete)	21
		industrial hoses	120
<b>C</b>		<b>K</b>	
cables	48	knurled nuts	132
cap nuts	132	knurled screws	132
clamps	129, 135		
coil heating elements	3	<b>L</b>	
condensators & interference suppression filters	47	lamps	20
consumables	136		
contactors	25	<b>M</b>	
control equipment	17	magnetic switches	16
control thermostats	8	measuring equipment	129
countersunk screws	130	microswitches	12
cylinder head bolts	132	motors	36
<b>D</b>		<b>N</b>	
digital timers	25	neon light bulbs	20, 21
door seals for dishwashers	113	Niplaflex hoses	120
dosing pumps	116	nuts	132
double nipples	126		
drain hoses	119	<b>O</b>	
drain pumps	46	operating capacitors	47
		O-rings	105
<b>E</b>			
electric accessories	48	<b>P</b>	
electrodes	36	plunger sockets	10
		position switches	13
<b>F</b>		pressure control hoses	120
fasteners	135	pressure switches	35
fastening material	130	probes	27
filters	47	programme timers	22
fine fuses	136	pumps	37
fittings	126	push/momentary push switches	11
flat-headed bolts	131	PVC supply hoses	119
float switches	15		
foam rubber gaskets	112	<b>R</b>	
foil heating elements	8	reducers	126
formed hoses	120	relays	26
fuses	48, 136	retaining rings	135
		ribbon cables	48
<b>H</b>		rocker/momentary rocker switches	11
heating elements	3	rotary switches	15
heating elements for pasta cookers	3		
hexagonal nuts	132	<b>S</b>	
hexagonal screws	131	safety bi-metal thermostats	8
hose clamps	129, 135	safety thermostats	9
hose connectors	126, 127	screw caps	136
hoses	119	screws	130

Зип Общепит

vsezip.ru

+7(812)987-08-81

sealing washers	110
shaft gaskets	113
sheet metal screws	130
snap locks	104
solenoid valves	100
spring rings	153
supply filters	129, 129
supply hoses	119
switches and momentary switches	11
system switches (ROLD)	13

**T**

tank inlets	119
terminals	48
thermostat gaskets	114
thermostats	8
time relays	27
timers	22
tooth lock washers	134

**W**

wash and rinse pumps	37
washers	134
water cycle components	129